

ك

المجوهرات خليفة
Khailifa Jewellery

FF

BIJOUTERIE
F A R A H

مَجَوَهَرَات فَرَج





















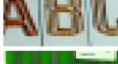

أفضل وأدق أنواع العدة والماكينات في العالم
لصناعة المجوهرات

WORLD'S FINEST PRECISION TOOLS & MACHINERY
FOR JEWELLERY MANUFACTURING

















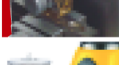

a trusted name in Jewelry Crafting Techniques offers you an innovative line of Tools, Supplies and Equipment to transform your visions into contemporary or traditional art forms. We are delighted to present our comprehensive catalog with dedicated sections that feature a concise listing of pictorially illustrated products. With years of experience, we have become a primary supplier to the needs of metalsmiths in the industry. To meet the challenges of modern day techniques our range of selected professional tools covers all aspects of jewelry making, wax carving, casting, raising, forming, sculpting, setting, finishing and more..... Over the years, we've built a reputation for on-time delivery, competitive pricing and quality tested products to satisfy the demanding needs of distributors and professional jewelers. Today, we're better prepared than ever to meet the growing needs of global markets that have changed over the years. When you think of quality with value - Think IKOHE.

Contents Page

	ABRASIVES & MANDRELS	1
21-		
	BEADING & BOOKS	27
22, 61		
	BENCH ACCESSORIES	39
23-		
	BRUSHES	51
24-		
	BUFFS	57
25-		
	BURS	69
26-		
	CASTING	81
27-		
	CLEANERS	101
28-		
	DAPPING	109
29-		
	DIAMOND TOOLS	115
30-		
	DRILLS	131
31-		
	ENGRAVING	135
32-		
	FILES	147
33-		
	FLEXSHAFTS	157
34-		
	GAUGES	163
35-		
	GEMOLOGICAL	171
36-		
	GRAVERS	175
37-		
	HAMMERS	183
38-		
	LOUPES	189
39-		
	PLATING	199
40-		
	PLIERS	209
41-		
	POLISHING	223
42-		

Contents Page

	RING TOOLS	231
43-		
	ROLLING MILLS	237
44-		
	SAFETY	243
45-		
	SAW FRAMES	245
46-		
	SCALES	249
47-		
	SCREWDRIVERS	257
48-		
	SETTING TOOLS	259
49-		
	SOLDERING	267
50-		
	STAMPING	275
51-		
	SURFACE FINISHING	279
52-		
	TAGS	289
53-		
	TESTING	293
54-		
	TORCHES	297
55-		
	TWEEZERS	307
56-		
	VICES	313
57-		
	WATCH TOOLS	315
58-		
	WAXES	325
59-		
	WORKBENCHES	345
60-		
	LABELING & PACKAGING	348
	CHARTS & INDEX	

Each item in this catalog has a six digit number

Product Code—

21	-	1066
----	---	------

—Product Line

Please use these numbers when placing your order to ensure that the correct products are shipped to you. However even if you do not have our Item number, just let us know what you need and we will be pleased to assist you.



ABRASIVES

- 3M® Flat Sanding Strips 3
- 3M® Flex Diamond Bands 5
- 3M® PSA Micro-Finishing Discs 3
- 3M® Wet or Dry Sheets 2
- 3M® Micro-Finishing Film Sheets 2
- 3M® Platinum Fre-Cut Sheets 2
- 3M® Professional Shop Rolls 4
- 3M® PSA Diamond Lapping Discs 2
- 3M® PSA Diamond Strips 3
- 3M® PSA Sanding Discs 2
- 3M® Sanding Bands Sic / Alo / Ceramic 4
- 3M® Shop Rolls 3
- 3M® Silicon Carbide Sikit Rolls 4
- 3M® Trizact Sanding Bands / Cartridge Rolls 5
- 3M® Wet or Dry Polishing Paper 2
- Adalox Discs 8
- Aluminum Back Plates 23
- Arkansas Stones 26
- Brightboy Wheels, Points, Pumice & Tablet 12
- Ceratone Polishers 22
- Cone Drum Sander 23
- Cratex® Assortment Kits 11
- Cratex® Blocks & Sticks 11
- Cratex® Large Wheels 11
- Cratex® Wheels & Points 10
- Cut-off Wheels 13
- Dedeco Miracle Gold Wheels 18
- Dedeco Rubber Flexie Polishers 19
- Diamond Cutting Discs 9
- E. C. Moore Discs 13
- Edenta TopStar, Goldino & Ocean 13
- Emery Ring Shells 13
- Emery Sticks 16
- EVE Airflex Polishing Wheels- Large 16
- EVE Airflex Polishing Wheels- Small 16



- EVE Mounted EVEflex Polishers 16
- EVE Platinum, Diamond & Pumice Wheels 17
- EVE Silicone Polishers 15
- EVE Silicone Rubber Points & Wheels 14
- Expandable Drum Arbors 23
- Flap Wheels 13
- Graver Sharpeners 26
- IKOHE Rubberized Wheels 21
- IKOHE Silicone Ultra Flex Wheels 20
- IKOHE Silicone Wheels 20
- IKOHE Heatless Wheels 21
- IKOHE Platinum, Pumice Wheels 20
- KOYO / 3M Sanding Belts 7
- Mandrels- Screw, Split, Pin Chuck 24
- Mitchells Abrasive Tapes & Cords 22
- Norton® No Fil Durite Paper 6
- Norton® Oil 26
- Norton® S/Rolls, Cloths, Sheets & Discs 6
- Gem Shine Wheels 21
- Separating Discs 13
- Sharpening Stones 25, 26
- Shell Mandrels 13
- Shofu® Gold Polishing Kits 18
- Shofu® Mounted Stones & Points 18
- Shofu® Split Wood Mandrel 23
- Yellow Sanding Discs 8
- Zirconia Discs 8

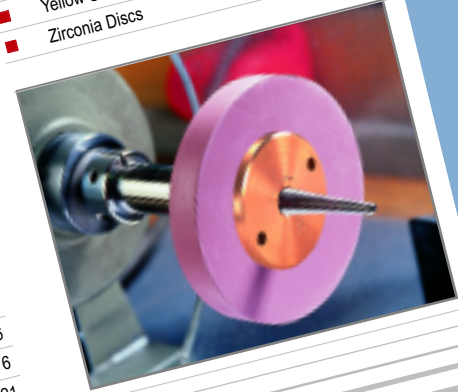

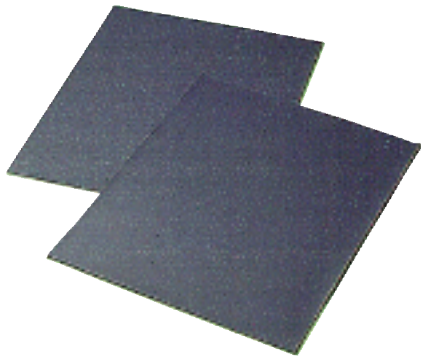

1. 3M® Wet or Dry Coated Abrasive Sheets

- Silicon Carbide, resin bonded to a soft paper backing
- May be used wet or dry
- Wear resistant and waterproof
- The higher the number the finer the grit

Tri-mite Pk/50

ITEM #	SIZE	GRIT
21-1011	9" X 11"	180
21-1012	9" X 11"	220
21-1013	9" X 11"	320
21-1014	9" X 11"	400
21-1015	9" X 11"	600

Imperial Pk/50

ITEM #	SIZE	GRIT
21-1016	9" X 11"	800
21-1017	9" X 11"	1000
21-1018	9" X 11"	1200
21-1019	9" X 11"	1500
21-1020	9" X 11"	2000
21-1021	9" X 11"	2500

2. 3M® Micro-Finishing Film Sheets

- Superior micron graded aluminum oxide
- Prepares surface for finishing prior to buffing
- Fine film backing is durable and long lasting
- The lower the number the finer the grit

Pk/50

ITEM #	SIZE	MIC	
21-1031	8½" X 11"	60	■
21-1032	8½" X 11"	40	■
21-1033	8½" X 11"	30	■

ITEM #	SIZE	MIC	
21-1034	8½" X 11"	15	■
21-1035	8½" X 11"	9	■

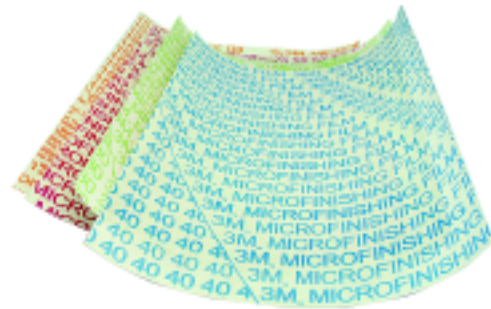

3. 3M® Platinum Fre-Cut Abrasive Sheets

- Micron graded paper for pre-polishing platinum
- Fre-Cut silicon carbide abrasive sheets
- Use dry only

Pk/100

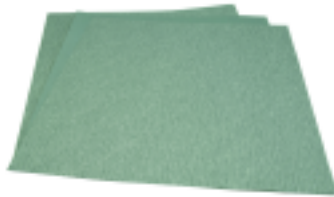

ITEM #	SIZE	GRIT
21-1041	9" X 11"	360
21-1042	9" X 11"	400
21-1043	9" X 11"	500

4. 3M® Wet or Dry Polishing Paper

- Pliable, non-woven, lint free backing
- Coated with micron sized abrasives
- May be used moist or dry

Pk/50



ITEM #	SIZE	MIC	
21-1051	8½" X 11"	30	■
21-1052	8½" X 11"	15	■
21-1053	8½" X 11"	9	■
21-1054	8½" X 11"	3	■
21-1055	8½" X 11"	2	■
21-1056	8½" X 11"	1	■

5. 3M® PSA Sanding Discs

- Pressure sensitive backed silicon carbide discs
- For pre-finishing non-ferrous and precious metals
- Use wet or dry
- Must be used with 6" Ø flat flange
- Max. speed 3,000 rpm

Pk/25



ITEM #	SIZE	GRIT
21-1301	6" Ø	240
21-1302	6" Ø	400
21-1303	6" Ø	600

6. 3M® PSA Diamond Lapping Discs

- Consistent graded diamond on a pressure sensitive disc
- Lubricate with water to increase cutting
- Always mount on a 6" Ø flat flange
- Max. speed 3,000 rpm



ITEM #	SIZE	MIC
21-1311	6" Ø	9
21-1312	6" Ø	6
21-1313	6" Ø	1



7. 3M® PSA Micro-Finishing Discs

- Superior graded aluminum oxide pressure sensitive discs
- Must be used with a 6" aluminum back plate
- Ensures consistent surface finish
- Max. speed 3,000 rpm.

Pk/25

ITEM #	SIZE	MIC
21-1321	6" Ø	60
21-1322	6" Ø	30
21-1323	6" Ø	15
21-1324	6" Ø	9



Comparison Chart	
MICRON	GRIT
80	180
60	220
40	320
30	400
20	500
15	600
9	1200
6	2800
3	4000
2	6000
1	8000

Coarse
Fine

8. 3M® PSA Flex Diamond Strips

- Pressure sensitive backed flexible diamond strips
- May be affixed to hand files or sanding sticks
- Ideal for custom tooling
- Use with plastic file blank $\frac{3}{4}$ " X $11\frac{7}{8}$ " - 21-1560

ITEM #	SIZE	MIC
21-1581	$\frac{3}{4}$ " X 7"	125
21-1582	$\frac{3}{4}$ " X 7"	74
21-1583	$\frac{3}{4}$ " X 7"	40
21-1584	$\frac{3}{4}$ " X 7"	20

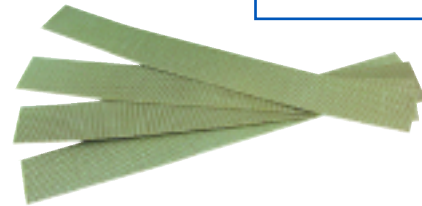

9. 3M® PSA Sanding Strips-Wet or Dry, Micro-Finishing Film, Trizact

- Premium quality pre-cut strips with pressure sensitive backing
- Easy to peel off and replace
- All grits to suit your exact needs
- Abrasive is $\frac{3}{4}$ " X 7" long



Use PSA strips with plastic file blank $\frac{3}{4}$ " X $11\frac{7}{8}$ " - 21-1560

Selection Chart			
	GRIT	MICRON	APPLICATION
Coarse (C)	220	60	Rapid Stock Removal
Medium (M)	325	45	General Smoothing
Fine (F)	600	25	Improves to a Satin Finish
Extra Fine (XF)	1200	9	Polishes & Shines

Wet or Dry Bx/10

ITEM #	GRIT	MIC.
21-1561	400	30
21-1562	600	15
21-1563	1200	9
21-1564	4000	3
21-1565	6000	2
21-1566	8000	1

Micro Finishing Film Bx/10

ITEM #	GRIT	MIC.
21-1567	180	80
21-1568	220	60
21-1569	320	40
21-1570	400	30
21-1571	600	15
21-1572	1200	9

Trizact Bx/10

ITEM #	GRIT	GRADE
21-1573	200	A100
21-1574	220	A80
21-1575	280	A65
21-1576	400	A45
21-1577	600	A30
21-1578	1200	A16

10. 3M® Shop Rolls

- Premium quality abrasive glue bonded to cloth
- Generates a smooth, clean surface on all metals
- Useful for in-house fabrication of drum sanders, flap wheels and sanding sticks

ITEM #	SIZE	GRIT
21-1201	1" X 50 YDS	80
21-1202	1" X 50 YDS	120
21-1203	1" X 50 YDS	180
21-1204	1" X 50 YDS	320

ITEM #	SIZE	GRIT
21-1206	1 $\frac{1}{2}$ " X 50 YDS	80
21-1207	1 $\frac{1}{2}$ " X 50 YDS	120
21-1208	1 $\frac{1}{2}$ " X 50 YDS	180
21-1209	1 $\frac{1}{2}$ " X 50 YDS	320



Use a Cone-Loc Drum Sander for Shop Rolls pg# 23



11. 3M® Professional Shop Rolls- Ruby

- Tough aluminum oxide bonded to cloth with 3M's heat resistant technology
- May be used for sanding sticks • Extends life four to five times over conventional shop rolls

ITEM #	SIZE	GRIT
21-1211	1" X 50 YDS	80
21-1212	1" X 50 YDS	120
21-1213	1" X 50 YDS	180
21-1214	1" X 50 YDS	280

ITEM #	SIZE	GRIT
21-1216	1½" X 50 YDS	80
21-1217	1½" X 50 YDS	120
21-1218	1½" X 50 YDS	180
21-1219	1½" X 50 YDS	280



12. 3M® Silicon Carbide Stikit Rolls-Platinum

- Tri-M-ite Fre-Cut, 414N finishing paper • Special coating resists loading
- Precisely graded for excellent surface preparation

ITEM #	SIZE	GRIT
21-1221	1½" X 50 YDS	80
21-1222	1½" X 50 YDS	100

ITEM #	SIZE	GRIT
21-1223	1½" X 50 YDS	120
21-1224	1½" X 50 YDS	150

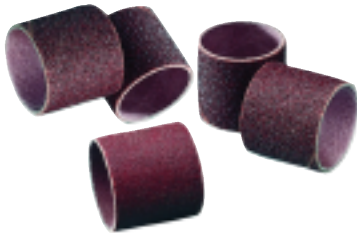

13. 3M® Sanding Bands-Silicon Carbide (SiC)

- Ideal for deburring, smoothing, and finishing flat or contoured surfaces • Use with drum arbors
- Suitable for pre-polish of gold, silver and alloys • Max speed- 12,000 rpm

Bx/100

ITEM #	SIZE	GRIT
21-1631	¼" X ½"	80
21-1632	¼" X ½"	120
21-1633	¼" X ½"	180
21-1634	¼" X ½"	240

ITEM #	SIZE	GRIT
21-1635	½" X ½"	80
21-1636	½" X ½"	120
21-1637	½" X ½"	180
21-1638	½" X ½"	240



14. 3M® Sanding Bands-Aluminum Oxide (AlO)

- Resin bonded bands of a softer abrasive • Use for pre-polishing ferrous or non-ferrous metal alloys
- Use with drum arbors • Max speed- 10,000 rpm

Bx/100

ITEM #	SIZE	GRIT
21-1641	¼" X ½"	80
21-1642	¼" X ½"	120
21-1643	¼" X ½"	180
21-1644	¼" X ½"	240

ITEM #	SIZE	GRIT
21-1645	½" X ½"	80
21-1646	½" X ½"	120
21-1647	½" X ½"	180
21-1648	½" X ½"	240

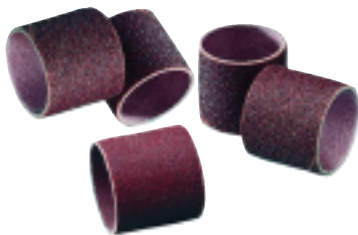

15. 3M® Ceramic Bands- Purple

- Ceramic wear resistant abrasive, lasts three to four times longer than normal aluminum oxide
- Provides a fast cutting rate • Lubricate with water • Use with expandable drum arbors
- Max speed -15,000 rpm

Bx/100

ITEM #	SIZE	GRIT
21-1651	½" X 1"	60
21-1652	½" X 1"	80

ITEM #	SIZE	GRIT
21-1653	½" X 1"	120
21-1654	½" X 1"	220





16. 3M® Flex Diamond Bands

- Coated with graded diamond abrasive in micron sizes • Ideal for inside ring mirror finishing
- Inter-spaced diamond nodes effectively withstand any debris build-up • Use with expanding drum arbors
- Max speed- 15,000 rpm

ITEM #	SIZE	MIC
21-1681	1/2" X 1/2"	250
21-1682	1/2" X 1/2"	125
21-1683	1/2" X 1/2"	74
21-1684	1/2" X 1/2"	40
21-1685	1/2" X 1/2"	20

ITEM #	SIZE	MIC
21-1686	1/2" X 1"	250
21-1687	1/2" X 1"	125
21-1688	1/2" X 1"	74
21-1689	1/2" X 1"	40
21-1690	1/2" X 1"	20

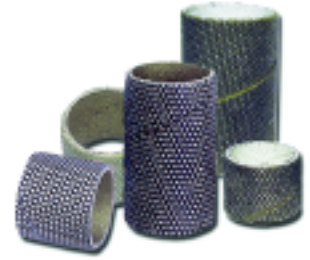

17. 3M® Trizact Sanding Bands

- Sanding bands of coated aluminum oxide with cutting points • Abrasion is smooth, reducing buffing time
- Use with expanding drum arbors • Max speed- 15,000 rpm

Bx/100

ITEM #	SIZE	GRIT
21-1661	1/2" X 1/2"	A100 200
21-1662	1/2" X 1/2"	A80 220
21-1663	1/2" X 1/2"	A65 280
21-1664	1/2" X 1/2"	A45 400
21-1665	1/2" X 1/2"	A30 600
21-1666	1/2" X 1/2"	A16 1200
21-1667	1/2" X 1/2"	A6 2500

ITEM #	SIZE	GRIT
21-1668	1/2" X 1"	A100 200
21-1669	1/2" X 1"	A80 220
21-1670	1/2" X 1"	A65 280
21-1671	1/2" X 1"	A45 400
21-1672	1/2" X 1"	A30 600
21-1673	1/2" X 1"	A16 1200
21-1674	1/2" X 1"	A6 2500

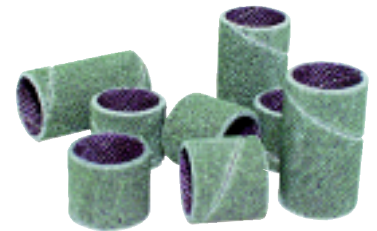

18. 3M® Cartridge Rolls-Regular

- A practical method for finishing inside and blind holes • Use with cartridge mandrels
- When the upper layer wears away, the layer beneath gets exposed to continue the smoothing process
- Max speed- 15,000 rpm

Bx/100

ITEM #	Ø X L X H	GRIT
21-1701	1/2" X 3/4" X 1/8"	60
21-1702	1/2" X 3/4" X 1/8"	80
21-1703	1/2" X 3/4" X 1/8"	120
21-1704	1/2" X 3/4" X 1/8"	180
21-1705	1/2" X 3/4" X 1/8"	240
21-1706	1/2" X 3/4" X 1/8"	320

ITEM #	Ø X L X H	GRIT
21-1707	1/2" X 1" X 1/8"	60
21-1708	1/2" X 1" X 1/8"	80
21-1709	1/2" X 1" X 1/8"	120
21-1710	1/2" X 1" X 1/8"	180
21-1711	1/2" X 1" X 1/8"	240
21-1712	1/2" X 1" X 1/8"	320



Cartridge roll mandrels pg # 23

19. 3M® Cartridge Rolls-Full Tapered

- Use with cartridge mandrels for finishing inside tapered holes
- When the upper layer wears away, the layer beneath gets exposed to continue the smoothing process
- Max speed- 15,000 rpm

Bx/100

ITEM #	Ø X L X H	GRIT
21-1718	1/2" X 1" X 1/8"	60
21-1720	1/2" X 1" X 1/8"	120

ITEM #	Ø X L X H	GRIT
21-1721	1/2" X 1 1/2" X 1/8"	60
21-1722	1/2" X 1 1/2" X 1/8"	80
21-1723	1/2" X 1 1/2" X 1/8"	120
21-1724	1/2" X 1 1/2" X 1/8"	180





NORTON

20. Metalite Shop Rolls



- Aluminum oxide, resin bonded to a cloth backing
- May be used for pre-finishing all metals
- Suitable for use in numerous applications: making flaps, regular or tapered cones and split mandrels

ITEM #	SIZE	GRIT
21-1231	1½" X 50 YDS	60
21-1232	1½" X 50 YDS	80
21-1233	1½" X 50 YDS	100
21-1234	1½" X 50 YDS	120
21-1235	1½" X 50 YDS	150
21-1236	1½" X 50 YDS	180
21-1237	1½" X 50 YDS	220
21-1238	1½" X 50 YDS	240

ITEM #	SIZE	GRIT
21-1241	2" X 50 YDS	80
21-1242	2" X 50 YDS	120
21-1243	2" X 50 YDS	150
21-1244	2" X 50 YDS	180
21-1245	2" X 50 YDS	240



Use a Cone-Loc Drum Sander for Shop Rolls pg# 23

NORTON

21. Emery Cloth Sheets

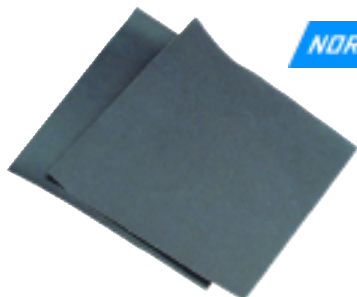

- Engineered for maximum flexing and fast cutting
 - Use for blending, fine sanding and polishing
 - Longer life than paper sheet
- Pk/50

ITEM #	SIZE	GRADE
21-1081	9" X 11"	COARSE
21-1082	9" X 11"	MEDIUM
21-1083	9" X 11"	FINE

NORTON

22. PSA Emery Discs



- Soft, adhesive backed emery discs
 - Affix directly on felt wheel faces
 - Economical for use either wet or dry
- Pk/50

ITEM #	SIZE	GRIT
21-1341	6" Ø	80
21-1342	6" Ø	100
21-1343	6" Ø	120

NORTON

23. Emery Polishing Paper

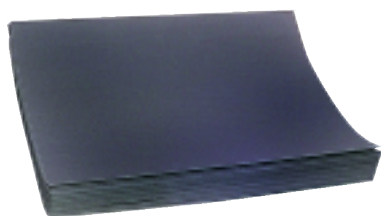

- Corundum grains are glue bonded to a paper back
 - Efficient for dry, satin, smooth polishing
 - Fine graded abrasive papers smooth surfaces to a high degree of finish
- Pk/50

ITEM #	SIZE	GRIT
21-1091	8½" X 14"	#4/0
21-1092	8½" X 14"	#3/0
21-1093	8½" X 14"	#2/0

ITEM #	SIZE	GRIT
21-1094	8½" X 14"	#0
21-1095	8½" X 14"	#1
21-1096	8½" X 14"	#2
21-1097	8½" X 14"	#3

NORTON

24. No Fil Durite Paper

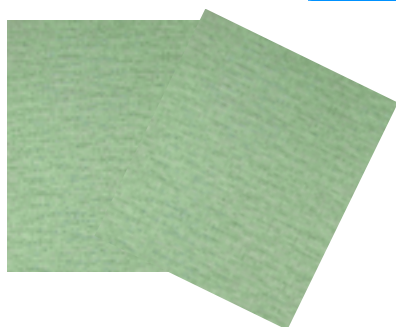

- Sharp silicon carbide abrasive bonded to a light weight paper backing
 - Papers are flexible yet durable
 - Excellent for finishing hard materials like platinum and titanium
- Pk/100

ITEM #	SIZE	GRIT
21-1101	9" X 11"	80
21-1102	9" X 11"	120
21-1103	9" X 11"	150
21-1104	9" X 11"	180
21-1105	9" X 11"	220



25. 3M® Trizact 217E Sanding Belt

A flexible cloth backing and aluminum oxide mineral makes 3M® 217E a perfect choice for critical finishing applications. 217E starts sharp and stays sharp, resulting in more predictable finer finishes. Use moderate to light pressure when using this product. Belts are 1" x 10½" long.

ITEM #	GRIT	
21-1746	A100	180
21-1747	A80	220
21-1748	A45	400
21-1749	A30	600

APPLICATION
Graver and chisel sharpening, Metal Finishing (gold, silver, brass, copper, platinum, stainless steel). Excellent product for stainless steel knife blades.



Wolf Belt Sander
See page# 44



Trizact 217E

26. 3M® "XODust" 900DZ Sanding Belt

These purple belts are coated with Cubitron™ ceramic aluminum oxide mineral, simply the best you can get, for a faster rate of material removal. Belts are 1" x 10½" long.

ITEM #	GRIT	
21-1751	80J	
21-1752	120J	
21-1753	220J	

APPLICATION
Sprue removal, Casting clean-up. Good for all types of metal, wood and plastics.



900DZ

27. 3M® Imperial Micro-finishing Film 372L

A high-strength polyester film backing is coated with premium, micron-graded mineral particles that are electrostatically oriented for greater cutting efficiency, and resin-bonded for increased durability. The result: a fast cutting abrasive that provides precise, consistently uniform, close tolerance finishes. Use moderate to light pressure. Bur Lube can be used as a lubricant and coolant. Belts are 1" x 10½" long.

ITEM #	MIC	GRIT
21-1755	60µ	220
21-1756	30µ	400
21-1757	15µ	600
21-1758	9µ	1200

APPLICATION
Metal, plastic, fiberglass, solid-surface composites and wood. Product can be run Wet or Dry.



Imperial Microfinishing 372L

28. 3M® Diamond Micro-finishing Film 675L

Provides the unique flexibility of film and the consistency of micron graded diamonds. You may find you will be able to start with a finer grade than normally used because of its more aggressive cut rate. Use water or Bur Lube, which will extend the life of the abrasive. Use moderate to light pressure. Belts are 1" x 10½" long.

APPLICATION
Stone, Metal, Enamel, Glass & Fiberglass.

ITEM #	MIC	ITEM #	MIC
21-1761	125µ	21-1764	30µ
21-1762	74µ	21-1765	20µ
21-1763	45µ		



Diamond Microfinishing 675L

29. KOYO® Ruby Belts

- Use for metal working, crafting and lapidary applications
- Fast cutting aluminum oxide
- Resin bonded to a flexible backing
- Belts are 1" x 10½" long.

APPLICATION
Metal, Wood, and Hobby Crafts

ITEM #	GRIT	ITEM #	GRIT
21-1741	80	21-1744	240
21-1742	120	21-1745	320
21-1743	180		



Ruby Belts



30. Zirconia Discs for -Platinum

- Extremely fast cutting abrasive, these new blue resin bonded sanding discs are thin and flexible • Use for pre-polishing, semi-finishing and blending
- Suitable for use on non-ferrous metals, precious metals, platinum and titanium • Max. speed 20,000 rpm



Actual size



Zirconia Pin Hole Discs- Bx/100 x 12

ITEM #	SIZE	GRADE
21-1404	3/4"	COARSE
21-1405	3/4"	MEDIUM
21-1406	3/4"	FINE



Use mandrel 21-2701 pg # 24

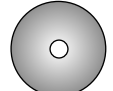

Pin Hole

ITEM #	SIZE	GRADE
21-1407	7/8"	COARSE
21-1408	7/8"	MEDIUM
21-1409	7/8"	FINE

Zirconia Snap-on Discs- Bx/50 x 12

GRADE	1/2"	5/8"	3/4"	7/8"
COARSE	21-1411	21-1414	21-1417	21-1420
MEDIUM	21-1412	21-1415	21-1418	21-1421
FINE	21-1413	21-1416	21-1419	21-1422



Use mandrel 21-2731 pg # 24

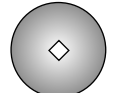

Snap-on

31. Adalox Discs

- Made of aluminum oxide, red brown in color • Resin bonded on to thin flexible back paper • Discs are long lasting and water resistant
- Suitable for smoothing and polishing non-ferrous and precious metals • Max. speed 20,000 rpm

Adalox Pin Hole Discs- Bx/100

ITEM #	SIZE	GRIT
21-1451	1 1/2"	80
21-1452	1 1/2"	100
21-1453	1 1/2"	120
21-1454	1 1/2"	220
21-1455	1 1/2"	320



Adalox Pin Hole Discs- Bx/100 x 12

GRADE	1/2"	5/8"	3/4"	7/8"
COARSE	21-1431	21-1434	21-1437	21-1440
MEDIUM	21-1432	21-1435	21-1438	21-1441
FINE	21-1433	21-1436	21-1439	21-1442



Use mandrel 21-2701 pg # 24

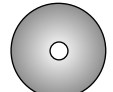

Pin Hole

Adalox Snap-on Discs- Bx/50 X12

GRADE	1/2"	5/8"	3/4"	7/8"
COARSE	21-1461	21-1464	21-1467	21-1470
MEDIUM	21-1462	21-1465	21-1468	21-1471
FINE	21-1463	21-1466	21-1469	21-1472



Use mandrel 21-2731 pg # 24

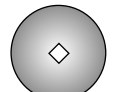

Snap-on

ikoh 32. Yellow Sanding Discs

- Graded aluminum oxide mounted on thin flexible backing • Specially designed for jewelry application • Excellent results in sanding and blending operation • Max. speed 20,000 rpm

Yellow Snap-on Discs

Bx/100

ITEM #	SIZE	GRADE
21-1481	3/4"	COARSE
21-1482	3/4"	MEDIUM
21-1483	3/4"	FINE



Use mandrel 21-2731 pg # 24

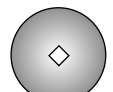

Snap-on

Bx/100

ITEM #	SIZE	GRADE
21-1484	7/8"	COARSE
21-1485	7/8"	MEDIUM
21-1486	7/8"	FINE





MOORE'S 33. Adalox Pin Hole / Snap-on Discs

• Premium quality aluminum oxide red brown in color glue bonded to a paper backing • Max speed 20,000 rpm

Pin-hole Bx/100 x 12

ITEM #	SIZE	GRADE
21-1501	3/4"	COARSE
21-1502	3/4"	MEDIUM
21-1503	3/4"	FINE
21-1504	7/8"	COARSE
21-1505	7/8"	MEDIUM
21-1506	7/8"	FINE

Snap-on Bx/50 x 12

ITEM #	SIZE	GRADE
21-1507	3/4"	COARSE
21-1508	3/4"	MEDIUM
21-1509	3/4"	FINE
21-1510	7/8"	COARSE
21-1511	7/8"	MEDIUM
21-1512	7/8"	FINE



MOORE'S Waterproof Pin Hole / Snap-on Discs

• Premium quality silicon carbide glue bonded to a paper backing • Max speed 20,000 rpm

Pin-hole Bx/100 x 12

ITEM #	SIZE	GRADE
21-1513	3/4"	COARSE
21-1514	3/4"	MEDIUM
21-1515	3/4"	FINE
21-1516	7/8"	COARSE
21-1517	7/8"	MEDIUM
21-1518	7/8"	FINE

Snap-on Bx/50 x 12

ITEM #	SIZE	GRADE
21-1519	3/4"	COARSE
21-1520	3/4"	MEDIUM
21-1521	3/4"	FINE
21-1522	7/8"	COARSE
21-1523	7/8"	MEDIUM
21-1524	7/8"	FINE

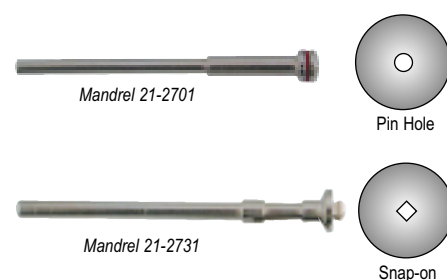

MOORE'S Emery Pin Hole / Snap-on Discs

• Premium quality, black silicon carbide glue bonded to a paper backing • Max speed 20,000 rpm

Pin-hole Bx/100 x 12

ITEM #	SIZE	GRADE
21-1525	3/4"	COARSE
21-1526	3/4"	MEDIUM
21-1527	3/4"	FINE
21-1528	7/8"	COARSE
21-1529	7/8"	MEDIUM
21-1530	7/8"	FINE

Snap-on Bx/50 x 12

ITEM #	SIZE	GRADE
21-1531	3/4"	COARSE
21-1532	3/4"	MEDIUM
21-1533	3/4"	FINE
21-1534	7/8"	COARSE
21-1535	7/8"	MEDIUM
21-1536	7/8"	FINE

• For pin hole discs use mandrel 21-2701 pg # 24
• For snap-on discs use mandrel 21-2731 pg # 24

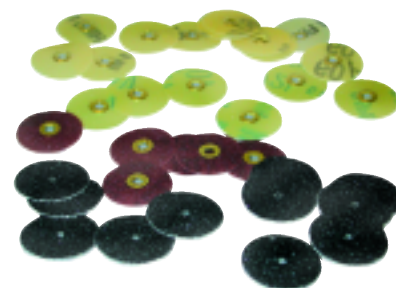

MOORE'S Moorplastic Sand Pin Hole / Snap-on Discs

• White aluminum oxide electrostatically bonded to a reinforced plastic backing • Max speed 20,000 rpm

Pin-hole Bx/100 x 12

ITEM #	SIZE	GRADE
21-1537	3/4"	COARSE
21-1538	3/4"	MEDIUM
21-1539	3/4"	FINE
21-1540	7/8"	COARSE
21-1541	7/8"	MEDIUM
21-1542	7/8"	FINE

Snap-on Bx/50 x 12

ITEM #	SIZE	GRADE
21-1543	3/4"	COARSE
21-1544	3/4"	MEDIUM
21-1545	3/4"	FINE
21-1546	7/8"	COARSE
21-1547	7/8"	MEDIUM
21-1548	7/8"	FINE



MOORE'S Magnum Snap-on Discs

• Aluminum oxide electrostatically bonded to a reinforced waterproof backing • Max speed 20,000 rpm

Snap-on Bx/100

SIZE	COARSE	MEDIUM	FINE
3/4"	21-1551	21-1552	21-1553
7/8"	21-1554	21-1555	21-1556



CRATEX 34. Small Rubber Bonded Wheels

- A perfect blend of premium grade silicon carbide in a durable resilient rubber bond
 - Removes scratch marks and surface defects • Ideal for work on intricate settings and filigree
 - Use on precious metals, glass, plastic and stones
 - **Coarse(Green), Medium(Brown), Fine(Red Brown) and Ex-Fine(Gray/Green)**
 - All wheels have a 1/16" arbor hole • Use mandrel 21-2701 (pg# 24) • Max. speed 25,000 rpm
- Bx/100**

SHAPE	DIA. X T	STYLE	COARSE	MEDIUM	FINE	EX-FINE
WHEEL	5/8" X 3/32"	53	21-1771	21-1772	21-1773	21-1774
WHEEL	5/8" X 1/8"	54	21-1775	21-1776	21-1777	21-1778
WHEEL	7/8" X 1/8"	74	21-1779	21-1780	21-1781	21-1782
WHEEL	1" X 1/8"	80	21-1783	21-1784	21-1785	21-1786
K/EDGE	5/8" X 3/32"	2	21-1787	21-1788	21-1789	21-1790
K/EDGE	1" X 1/8"	5	21-1791	21-1792	21-1793	21-1794



CRATEX 35. Cylinders & Points

- Flexible abrasive finisher for deburring, smoothing and polishing • Cushioned action performance
 - Operate with light pressure • Max. speed 25,000 rpm • Wheels have a 1/16" arbor hole
 - Use mandrel 21-2716 (pg# 24)
- Bx/100**

SHAPE	DIA. X T	STYLE	COARSE	MEDIUM	FINE	EX-FINE
CYLINDER	1/4" X 7/8"	6	21-1801	21-1802	21-1803	21-1804
BULLET	9/32" X 1"	8	21-1805	21-1806	21-1807	21-1808
BULLET	1/4" X 7/8"	11	21-1809	21-1810	21-1811	21-1812
TAPERED	3/8" X 7/8"	12	21-1813	21-1814	21-1815	21-1816
BULLET	1/2" X 7/8"	15	21-1817	21-1818	21-1819	21-1820

Selection Chart

GRIT	APPLICATION
80	Deburring / Satin Finish
120	Blending / Polish Finish
180	Smoothing / V/fine Finish
320	Super / Ultra High Finish

CRATEX 36. MX Wheels & Mounted Cylinders

- Fine aluminum oxide in a cotton fiber rubber bond • Use with light pressure
- Specially for finishing aluminum, stainless steel and precious metals
- Use mandrel 21-2706 (pg# 24) • Max. speed 25,000 rpm

SHAPE	DIA. X T X H	80 GRIT	120 GRIT	180 GRIT	320 GRIT
WHEEL	1" X 1/16" X 1/8"	21-1831	21-1832	21-1833	21-1834
WHEEL	1" X 1/8" X 1/8"	21-1835	21-1836	21-1837	21-1838

- Mounted Cylinders come with 1/8" shank.

SHAPE	DIA. X T	STYLE	80 GRIT	120 GRIT	180 GRIT	320 GRIT
CYLINDER	1/4" X 1/2"	W163	21-1841	21-1842	21-1843	21-1844
CYLINDER	1/4" X 3/4"	W164	21-1845	21-1846	21-1847	21-1848
CYLINDER	3/8" X 1/2"	W176	21-1849	21-1850	21-1851	21-1852
CYLINDER	3/8" X 3/4"	W177	21-1853	21-1854	21-1855	21-1856

CRATEX 37. Small Pumice Wheels

- Made from natural rubber with fine graded pumice • Operate with light pressure for maximum shine on precious metals • Max. speed 25,000 rpm • Use mandrel 21-2701 (pg# 24)
- Bx/100**

ITEM #	SHAPE	DIA. X T X H	STYLE
21-1873	WHEEL	7/8" X 1/8" X 1/16"	74P
21-1875	K/EDGE	5/8" X 3/32" X 1/16"	2P
21-1878	K/EDGE	1" X 1/8" X 1/16"	5P



CRATEX 38. Blocks & Sticks

- Use for manual or mechanical shaping and sharpening
- Round stones may be mounted in chucks
- Square stones may be used in tool holding fixtures

SHAPE	SIZE	STYLE	COARSE	MEDIUM	FINE	EX-FINE
SQUARE	6" X 1/4"	6202	21-1931	21-1932	21-1933	21-1934
SQUARE	6" X 1/2"	6404	21-1935	21-1936	21-1937	21-1938
ROUND	6" X 3/16"	036	21-1943	21-1944	21-1945	21-1946
ROUND	6" X 1/4"	046	21-1947	21-1948	21-1949	21-1950
ROUND	6" X 5/16"	056	21-1951	21-1952	21-1953	21-1954
ROUND	6" X 3/8"	066	21-1955	21-1956	21-1957	21-1958
ROUND	6" X 1/2"	086	21-1959	21-1960	21-1961	21-1962



CRATEX 39. Large Wheels

- Large wheels for general applications, roughing and smoothing
- Do not exceed maximum safe speed
- Wheel 1 1/2" Ø - 15,000 rpm. Use mandrel 21-2706
- Wheel 4" Ø - 5,250 rpm. Use arbor 42-1361 LH, 42-1362 RH
- Wheel 6" Ø - 3,600 rpm. Use arbor 42-1361 LH, 42-1362 RH

USE OF ABRASIVE WHEELS

For your safety it is important to follow the rules in the ANSI B7.1 Safety code. The rules cover operating procedures for speed, guards, flanges, mounting, storage and inspection.

Ø X T X AH*	STYLE	COARSE	MEDIUM	FINE	EX-FINE
1 1/2" X 1/8" X 1/8"	152	21-1881	21-1882	21-1883	21-1884
4" X 1/8" X 1/2"	402	21-1891	21-1892	21-1893	21-1894
4" X 1/4" X 1/2"	404	21-1895	21-1896	21-1897	21-1898
4" X 1/2" X 1/2"	408	21-1899	21-1900	21-1901	21-1902
6" X 1/8" X 1/2"	602	21-1903	21-1904	21-1905	21-1906
6" X 1/4" X 1/2"	604	21-1907	21-1908	21-1909	21-1910
6" X 1/2" X 1/2"	608	21-1911	21-1912	21-1913	21-1914

AH: Arbor Hole



CRATEX 40. Assortment Kits

- Specially formulated, cushioned action performance on precious metals

21-1921 Style #707

Style #707: 44 wheels and 2 mandrels in a four compartment plastic box. Wheels are equally assorted in all four grit textures.

21-1922 Style #767

Style #767: 40 points and 4 mandrels in a four compartment plastic box. Points are equally assorted in all four grit textures.

21-1925 Style #777

Style #777: 80 small wheels and points in popular sizes and grits. Comes with four mandrels and 5/8" to 1" sizes of wheels and points in clear divided box.

21-1926 Style #778

Style #778: 64 points and cylinders, 2 each of all eight shapes in each of the 4 grits and 4 each 1/8" shank mandrel.

21-1927 Style #779

Style #779: 45 wheels and 2 mandrels in a four compartment plastic box. Wheels are equally assorted in all four grit textures.





41. Brightboy® Wheels & Points

• Aluminum oxide or silicon carbide on a flexible rubber bond • Recommended for prepolish on stainless steel, chrome and precious metals • Max. speed 20,000 rpm

A-Aluminum Oxide S-Silicon Carbide Average 70 Grit Use mandrel 21-2701 (pg# 24)

SQ/EDGE WHITE FLEX WHEELS: Bx/100

ITEM #	Ø X T X AH	GRIT	STYLE	COLOR
21-2011	5/8" X 1/16" X 1/16"	EX-FINE-A	#721	WHITE
21-2012	7/8" X 1/8" X 1/16"	EX-FINE-A	#722	WHITE

K/EDGE WHEELS: Bx/100

ITEM #	Ø X T X AH	GRIT	STYLE	COLOR
21-2021	5/8" X 3/32" X 1/16"	FINE-S	#732	RED FLEX
21-2022	7/8" X 1/8" X 1/16"	MEDIUM-S	#752	GREEN

SQ/EDGE WHEELS: Bx/100

ITEM #	Ø X T X AH	GRIT	STYLE	COLOR
21-2016	7/8" X 1/8" X 1/16"	FINE-S	#723	RED FLEX
21-2017	7/8" X 1/8" X 1/16"	MEDIUM-S	#724	GREEN
21-2018	7/8" X 1/8" X 1/16"	COARSE-S	#725	BLACK
21-2019	7/8" X 1/8" X 1/16"	FINE-S	#726	BLUE

MOUNTED BULLET POINTS: All mounted points come with 3/32" shank.

Bx/10

ITEM #	Ø X T	GRIT	STYLE	COLOR
21-2031	1/8" X 7/8"	FINE-S	#761	WHITE
21-2032	1/8" X 7/8"	MEDIUM-S	#762	RED
21-2033	1/8" X 7/8"	COARSE-S	#763	BLUE
21-2034	1/8" X 7/8"	FINE-S	#765	BLACK

42. Brightboy® Pumice Wheels

• Specially designed for fine finishing and polishing of stainless steel and precious metals

• **White**- Fine grit pumice; **Blue** - Extra fine grit pumice • Arbor hole 1/16"

• Max. speed 20,000 rpm • Use mandrel 21-2701 (pg# 24)

Bx/100

ITEM #	Ø X T X AH	SHAPE	STYLE
21-2041	5/8" X 5/32" X 1/16"	SQ/EDGE	WR822-BLUE
21-2042	7/8" X 1/8" X 1/16"	SQ/EDGE	WR888-BLUE
21-2043	5/8" X 5/32" X 1/16"	K/EDGE	WR999-WHITE
21-2044	5/8" X 5/32" X 1/16"	K/EDGE	WR999-BLUE

43. Brightboy® Large Wheels

• Wide application for rough grinding, smoothing and polishing of castings • Average 70 grit

• Wheel 3" Ø use mandrel 21-2709; Wheel 4" Ø Use arbor 42-1361, 42-1362

ITEM #	Ø X T X AH	MAX. SPEED	STYLE
21-2051	3" X 3/8" X 1/4"	5,000RPM	ST70ALO
21-2052	3" X 1/2" X 1/4"	5,000RPM	ST70ALO
21-2053	4" X 1/2" X 1/2"	3,600RPM	ST70ALO

44. Brightboy® Tablet

• A general surface cleaning and finishing abrasive stone • Ideal for removing scratches or oxydation

ITEM #	DIMENSIONS	SHAPE	STYLE
21-2061	2 1/4" X 1 1/8" X 3/8"	TABLET	88 BIAS



45. Flap Wheels

- Use with flex shafts for blending flat or contoured surfaces • Max. speed 15,000 rpm • Shank size $\frac{3}{32}$ "

ITEM #	SIZE	GRIT
21-2071	20 X 10MM	100
21-2072	20 X 10MM	150
21-2073	20 X 10MM	240
21-2074	20 X 10MM	320

ITEM #	SIZE	GRIT
21-2076	20 X 5MM	100
21-2077	20 X 5MM	150
21-2078	20 X 5MM	240
21-2079	20 X 5MM	320



46. Emery Sticks

- Various grades of emery paper, glued to flat wood handles $9"$ x $\frac{3}{4}"$ • Abrasive is $7"$ long
- Use for manual sanding and polishing of all materials

ITEM #	GRIT	GRADE
21-2081	#3	COARSE
21-2082	#2	COARSE
21-2083	#1	MEDIUM

ITEM #	GRIT	GRADE
21-2084	2/0	FINE
21-2085	3/0	FINE
21-2086	4/0	FINE



47. Ring Shell Mandrels

- Seasoned wood mandrels provide a snug fit for emery ring shells
- Pre-drilled center hole for use on a bench polisher



ITEM #	LENGTH
21-2097	6"
21-2098	7"

50. Emery Ring Shells

- Smooths and polishes the inside of rings • Available in cloth or paper
- Mounts on ring shell mandrels • Grits from coarse to fine

ITEM #	DESCRIPTION
21-2091	PAPER SHELLS PKG/ 12
21-2092	P/SHELLS PKG/ 6 & MANDREL
21-2095	CLOTH SHELLS PKG/ 12
21-2096	C/SHELLS PKG/ 6 & MANDREL



48. Cut-off Wheels- Alo

- Resin bonded discs cut on both sides and edges
 - Use for slitting gold, silver and non-ferrous metals
 - Arbor hole $\frac{1}{16}"$
 - Max. speed 25,000 rpm.
 - Use mandrel AT-199 (pg# 24)
- Bx/100

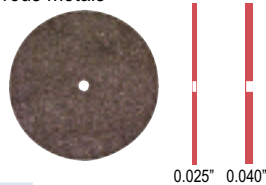

ITEM #	Ø X T
21-2641	$1\frac{1}{2}"$ X 0.025"
21-2642	$1\frac{1}{2}"$ X 0.040"

51. Separating Discs

- Fast cool cutting aluminum oxide discs
 - Cut on edge only • Use for precious metals
 - Arbor hole $\frac{1}{16}"$ • Max. speed 20,000 rpm
- Bx/100

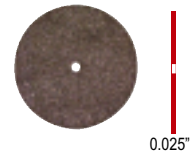

ITEM #	Ø X T
21-2651	$\frac{7}{8}"$ X 0.025"
21-2652	$1\frac{5}{16}"$ X 0.025"

49. Thin Separating Discs

- Thin discs of silicon carbide coated on both sides
- High precision work on all precious metals
- Arbor hole $\frac{1}{16}"$ • Max. speed 20,000 rpm

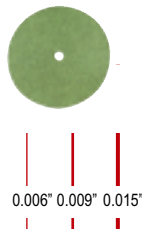

ITEM #	Ø X T	BX
21-2656	$\frac{7}{8}"$ X 0.015"	BX/50
21-2657	$\frac{7}{8}"$ X 0.009"	BX/25
21-2658	$\frac{7}{8}"$ X 0.006"	BX/25

52. Diamond Cutting Discs

- Thin fast cutting disc for non-ferrous alloys and precious metals
 - Arbor hole $\frac{1}{16}"$ • Max speed 15,000 rpm
- Bx/5



ITEM #	Ø X T
21-2661	$\frac{7}{8}"$ X 0.020"
21-2662	$1\frac{5}{16}"$ X 0.015"



Applications	Grade	Color
Reducing	Coarse	□
Smoothing	Medium	■
Luster	Fine	■
High Luster	X-Fine	■



EVE 53. Silicone Mounted Points

- Flexible open pore polishers in a silicone rubber bond • Specially suited for extra fine mirror finishing
- Outlasts all other abrasives • Shank size 3/32" • Max speed 15,000 rpm

Bx/100



SIZE	11 X 2 MM	5.5 X 15 MM	11 X 2.5 MM	14 X 12 MM
GRADE	K/EDGE	FLAME	SQ/EDGE	CYLINDER
□ COARSE	21-2101	21-2105	21-2109	21-2113
■ MEDIUM	21-2102	21-2106	21-2110	21-2114
■ FINE	21-2103	21-2107	21-2111	21-2115
■ X-FINE	21-2104	21-2108	21-2112	21-2116

EVE Silicone Unmounted Wheels and Points

- Fast cutting silicon carbide in a flexible bond • Specially suited for blending and contouring precious alloys
- Impregnated with micro-grit polishing compounds • Unmounted wheels have 1/16" arbor hole
- Max Speed 10,000 rpm

Bx/100

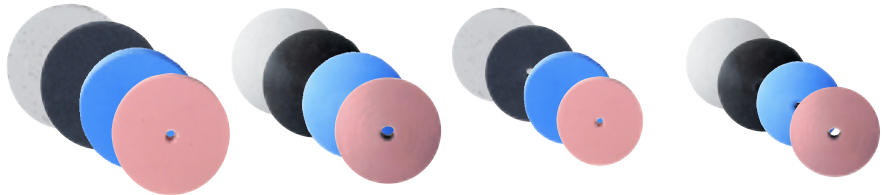

SIZE	Ø22 X 3 MM	Ø22 X 4 MM	Ø17 X 2.5 MM	Ø18 X 3.5MM
GRADE	SQ/EDGE	K/EDGE	SQ/EDGE	K/EDGE
□ COARSE	21-2121	21-2125	21-2129	21-2133
■ MEDIUM	21-2122	21-2126	21-2130	21-2134
■ FINE	21-2123	21-2127	21-2131	21-2135
■ X-FINE	21-2124	21-2128	21-2132	21-2136

Bx/100



SIZE	Ø 7 X 20 MM	Ø 9 X 20 MM	Ø 12 X 20 MM	Ø 6 X 24 MM
GRADE	CYL.	CYL.	CYL.	PT. CYL.
□ COARSE	21-2141	21-2145	21-2149	21-2153
■ MEDIUM	21-2142	21-2146	21-2150	21-2154
■ FINE	21-2143	21-2147	21-2151	21-2155
■ X-FINE	21-2144	21-2148	21-2152	21-2156



EVE 54. Silicone Satin Finish Polishers-BL

• Soft flexible polishers for satin finish on precious metal alloys • Arbor hole 1/16" • Medium grit • Max speed 7,000-10,000 rpm

Bx/100

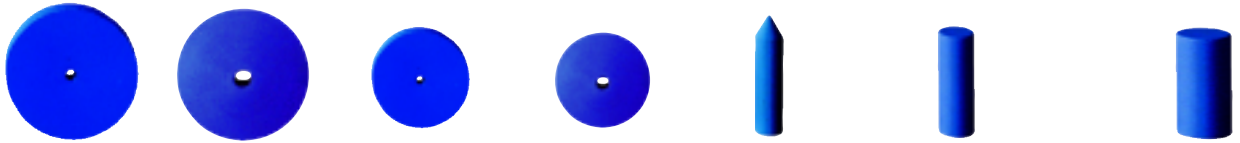

SIZE	Ø22 X 3 MM	Ø22 X 3 MM	Ø17 X 2.5 MM	Ø18 X 3.5 MM	Ø6 X 24 MM	Ø7 X 20 MM	Ø12 X 20 MM
GRADE	SQ/EDGE	K/EDGE	SQ/EDGE	K/EDGE	FLAME	CYLINDER	CYLINDER
■ MEDIUM	21-2201	21-2202	21-2203	21-2204	21-2205	21-2206	21-2207

EVE 55. Silicone Unmounted Wheels

- Wide polishing wheels to blend external or internal surfaces
- Unmounted wheels have 1/16" arbor hole
- Lubricate with water • Max speed 12,000 rpm

Bx/100

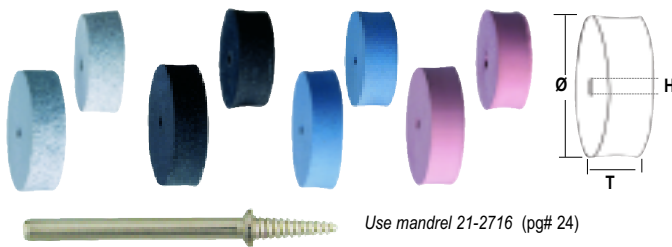

Use mandrel 21-2716 (pg# 24)

SIZE	Ø17 X 6 X 1.5 MM	Ø22 X 6 X 1.5 MM
GRADE	SQ/EDGE	SQ/EDGE
□ COARSE	21-2161	21-2165
■ MEDIUM	21-2162	21-2166
■ FINE	21-2163	21-2167
■ X-FINE	21-2164	21-2168

EVE 56. Silicone Inside Ring Polishers

- Polish the inside of rings to a mirror finish
- Unmounted wheels have 5mm arbor hole
- Lubricate with water • Max speed 12,000 rpm

Bx/10

for inside ring mandrel (pg# 23)



SIZE	Ø14 X 25 X 5 MM
GRADE	CYLINDER
□ COARSE	21-2171
■ MEDIUM	21-2172
■ FINE	21-2173
■ X-FINE	21-2174

EVE 57. Synthetic Rubber Polishing Pins

- Small diameter polishing pins are useful in hard to reach areas • Use without polishing compounds
- Achieve a mirror finish on all precious metals • Lubricate with water • Max speed 20,000 rpm

Bx/100

Use pin chuck mandrel (pg# 24)

*H/COARSE : Bond Hard Coarse **C/MEDIUM: Bond Coarse Medium



COLOR	BROWN	BLUE	GREY	RED.BROWN	GREEN
Ø X L	H/COARSE*	C/MEDIUM**	MEDIUM	FINE	X-FINE
2 X 20MM	21-2181	21-2182	21-2183	21-2184	21-2185
3 X 23MM	21-2186	21-2187	21-2188	21-2189	21-2190

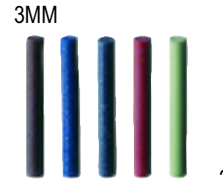
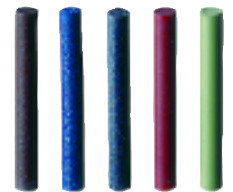

EVE 58. Silicone Polishing Wheels- Large

- Micro-fine abrasive impregnated wheels for polishing precious alloys
- Use without messy polishing compounds • Lubricate with water • Max speed max 3,800 rpm

SIZE Ø100 X 15 D X 12.7 AH MM

GRADE	ITEM #
□ COARSE	21-2191
■ MEDIUM	21-2192
■ FINE	21-2193
■ X-FINE	21-2194

USE OF ABRASIVE WHEELS
 For your safety it is important to follow the rules in the ANSI B7.1 Safety Code. The rules cover operating procedures for speed, guards, flanges, mounting, storage and inspection.





EVE 59. Airflex Polishing Wheels- Large

- Fine open pore structure for adequate cooling
- Aggressive cutting on all tough metals and alloys (platinum, S.S)
- Arbor hole 1/4" (6mm) • Max. speed 3,000 rpm

SIZE	Ø100 X 15 X 6 MM	
GRADE		ITEM #
COARSE	LT. BLUE	21-2211
MEDIUM	GREEN/GRAY	21-2212
FINE	LT. BROWN	21-2213

EVE 60. Airflex Polishing Wheels

- Fine open pore structure • High luster on platinum and precious alloys
 - Speed 7,000- max 10,000 rpm
- Bx/100



SHAPE	Ø X T X AH	COARSE	MEDIUM	FINE
SQ/EDGE	22 X 3 X 1.5MM	21-2214	21-2215	21-2216
SQ/EDGE	17 X 4 X 1.5MM	21-2217	21-2218	21-2219

EVE 61. Unmounted EVEFlex Polishers

- Premium quality polishers in a flexible bond that is superior to silicone
- Recommended for high luster finish on gold, silver and platinum
- Arbor hole is 1/16" • Speed 7,000- max 10,000 rpm

Bx/100



SIZE	22 X 3 MM	22 X 4 MM	7 X 20 MM
GRADE	WHEEL	K/EDGE	CYLINDER
COARSE	21-2221	21-2225	21-2229
MEDIUM	21-2222	21-2226	21-2230
FINE	21-2223	21-2227	21-2231
X-FINE	21-2224	21-2228	21-2232

EVE 62. Mounted EVEFlex Polishers

- Unique flexible bond polishing points for mirror finishing hard to reach areas on all precious metals • Mounted on 3/32" shanks
- Speed 7,000- max 10,000 rpm

Bx/10



SIZE	5 X 16 MM	14.5 X 2.5 MM	19 X 1 MM	14 X 12 MM	5.5 X 18 MM	14.5 X 2 MM
GRADE	BULLET	K/EDGE	FLOPPY	CYLINDER	FLAME	SQ/EDGE
COARSE	21-2236	21-2240	21-2244	21-2248	21-2252	21-2256
MEDIUM	21-2237	21-2241	21-2245	21-2249	21-2253	21-2257
FINE	21-2238	21-2242	21-2246	21-2250	21-2254	21-2258
X-FINE	21-2239	21-2243	21-2247	21-2251	21-2255	21-2259



EVE 63. Silicone Unmounted Platinum Polishers

- High quality silicone polishers for platinum, titanium and tough metals
- Arbor hole is $\frac{1}{16}$ " • Speed 7,000- max 10,000 rpm

Bx/100



SIZE	22 X 3 MM	22 X 4 MM	7 X 20 MM
GRADE	WHEEL	K/EDGE	CYLINDER
■ MEDIUM	21-2262	21-2265	21-2268
■ FINE	21-2263	21-2266	21-2269



EVE 64. Silicone Rubber Mounted Platinum Polishers

- High quality rubber polishers for platinum, titanium and tough metals
- Shank $\frac{3}{32}$ " • Speed 7,000- max 10,000 rpm

Bx/10



SIZE	5 X 16 MM	14.5 X 2.5 MM	14.5 X 2.5 MM	14 X 12 MM
GRADE	BULLET	K/EDGE	SQ/EDGE	CYLINDER
■ MEDIUM	21-2272	21-2275	21-2278	21-2281
■ FINE	21-2273	21-2276	21-2279	21-2282



EVE 65. Diamond Polisher for Platinum

- Platinum polishers for smoothing and super high luster
- Shank size $\frac{3}{32}$ " • Speed 7,000- max 10,000 rpm



SIZE	4 X 13 MM	11 X 2 MM	11 X 4 MM
GRADE	FLAME	SQ/EDGE	SQ/EDGE
■ MEDIUM	21-2301	21-2304	21-2307
■ FINE	21-2302	21-2305	21-2308
■ X-FINE	21-2303	21-2306	21-2309



Set consists of three each in Medium, Fine and X-fine.

Flame: 4 x 13 mm
Sq/edge: 11 x 2 mm
Sq/edge: 11 x 4 mm

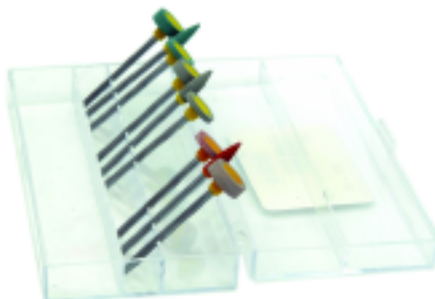

ITEM #	DESCRIPTION
21-2310	SET OF 9 PCS

EVE 66. Pumice Wheels

- Special wheels combine pumice fines in a silicone binder
- High luster finish on bezels and set stones, without the risk of scratches
- Arbor hole is $\frac{1}{16}$ " • Speed 7,000- max 10,000 rpm

Bx/100

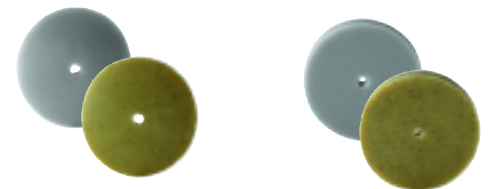

SIZE	22 X 4 MM	22 X 3 MM
GRADE	K/EDGE	SQ/EDGE
■ MEDIUM	21-2291	21-2293
■ FINE	21-2292	21-2294



67. Shofu® Mounted Stones

- Mounted stones are of high purity aluminum oxide free from carbon contamination
- **Coral stones** will finish chrome cobalt and nickel alloys • **Pink stones** are for pre-polishing of precious metals
- **White stones** are designed for finishing semi-precious stones • Shank size 3/32"
- Max. speed- 12,000 rpm

Shofu®
Mounted stones for pre-finishing and final polishing of precious metals, paladium and platinum.

Bx/12



SIZE	6 X 8 MM	3 X 22 MM	6 X 10 MM	4 X 8 MM
COLOR	TAPERED	WHEEL	BARREL	CONE
■ CORAL	21-2351	21-2354	21-2357	21-2360
■ PINK	21-2352	21-2355	21-2358	21-2361
□ WHITE	21-2353	21-2356	21-2359	21-2362

68. Polishing Points & Wheels

- High quality polishing abrasive in a silicone bond • Excellent to use for brilliant finishes on precious metals, gold, silver and alloys
- **Brownie** for pre-polish • **Greenie** for polish • **Super greenie** for super polish
- Mounted points have 3/32" shanks • Max. speed- 12,000 rpm

Bx/12



SIZE	5 X 6 MM	12.75 MM	3 X 20 MM	1 X 22 MM	3 X 22 MM
COLOR	BULLET	K/EDGE	SQ/EDGE	FLOPPY	WHL.UMT
■ BROWNIE	21-2371	21-2374	21-2377	21-2380	21-2386
■ GREENIE	21-2372	21-2375	21-2378	21-2381	21-2387
■ SUP. GRN	21-2373	21-2376	21-2379	21-2382	21-2388

Unmounted Wheels

- Arbor hole 1.5mm (1/16")

Bx/12



69. Gold Polishing Kit

- Ultra fine abrasive in a rubber bond will give a high quality surface finish
- **Brownie**-will generate a satin smoothness • **Greenie**- will impart a mirror bright finish
- **Super greenie**- will finish to a high luster • Shank size 3/32".

ITEM #	DESCRIPTION
21-2391	GOLD POLISHING KIT -12 PCS
KIT CONTAINS:	21-2371, 21-2374, 21-2377 - TWO EACH 21-2372, 21-2375, 21-2378, 21-2373, 21-2376, 21-2379 - ONE EACH

Approximate Conversion

MM	INCH	DECIMAL
1.5	1/16"	(0.062")
3.1	1/8"	(0.125")
4.8	3/16"	(0.187")
6.3	1/4"	(0.250")
7.8	5/16"	(0.312")
9.8	3/8"	(0.375")
12.7	1/2"	(0.500")
15.8	5/8"	(0.625")
19.0	3/4"	(0.750")
22.2	7/8"	(0.875")
25.4	1"	(1.000")

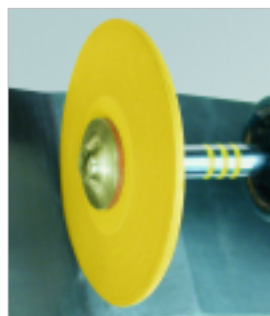

70. Dedeco® "Miracle Gold" Wheels

- High luster polish for gold and precious metal alloys
- Long lasting silicon carbide abrasives eliminate the need for rouge
- Lubricate with water • Arbor hole 1/16" • Speed max 15,000 rpm

Bx/100

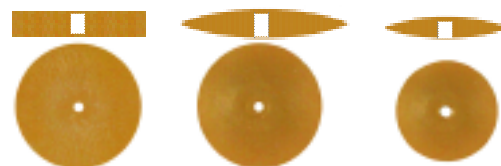

SIZE	Ø 7/8" X 1/8"	Ø 7/8"	Ø 5/8"
GRADE	SQ/EDGE	K/EDGE	K/EDGE
■ FINE	21-2421	21-2422	21-2423



71. Dedeco® Rubber Flexie Polishers

- High purity abrasives in a flexible bond for contour polishing of gold, silver and non-ferrous alloys
- Lubricate with water • Arbor hole 1/16" • Max speed max 20,000 rpm

Bx/100

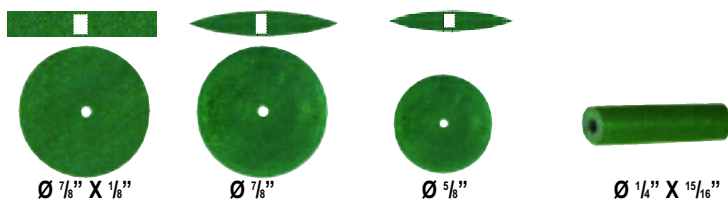

SIZE	Ø 7/8" X 1/8"	Ø 7/8"	Ø 5/8"	Ø 1/4" X 15/16"
GRADE	SQ/EDGE	K/EDGE	K/EDGE	CLASP
■ COARSE	21-2401	21-2404	21-2407	21-2410
■ FINE	21-2402	21-2405	21-2408	21-2411
□ FLEXIES	21-2403	21-2406	21-2409	21-2412



72. e IDENTA TopStar

- **Brown:** Pre-polishing of gold, composite and semi-precious alloys • **Green:** High-gloss polishing of all precious and semi-precious alloys • Mounted points have 3/32" shanks • Max speed 20,000 rpm

Bx/10



SIZE	Ø5 X 16 MM	Ø15 X 2.5 MM	Ø14.5 X 2 MM	Ø5.5 X 15.5 MM
GRADE	BULLET	K/EDGE	WHEEL	CONE
■ MEDIUM	21-2441	21-2443	21-2445	21-2447
■ FINE	21-2442	21-2444	21-2446	21-2448

Unmounted Wheel

- Arbor hole 1/16"

Bx/100



SIZE	Ø22 X 3 MM
GRADE	WHL. UNM
■ MEDIUM	21-2451
■ FINE	21-2452



73. e IDENTA Goldino

- Ultra polish for all precious alloys • Arbor hole 1/16"
- **Green:** finishing. Speed 20,000 rpm
- **Yellow:** pre-polish. Speed 15,000 rpm
- **Pink:** Ultra polish. Speed 10,000 rpm

Bx/100



SIZE	Ø22 X 3 MM	Ø6 X 22 MM	Ø22 X 3 MM
GRADE	SQ/EDGE	CYL.	K/EDGE
■ MEDIUM	21-2461	21-2464	21-2467
■ FINE	21-2462	21-2465	21-2468
■ X-FINE	21-2463	21-2466	21-2469

Mounted Point

- Shank 3/32"

Bx/10



SIZE	Ø5.5 X 15.50 MM
GRADE	POINT
■ MEDIUM	21-2471
■ FINE	21-2472
■ X-FINE	21-2473



74. e IDENTA Ocean

- Blue silicone rubber polishers are for pre-polishing of semi-precious alloys, chrome, cobalt and titanium • Arbor hole 1/16" • Mounted points have 3/32" shanks • Max speed 20,000 rpm

Bx/100



SIZE	Ø22 X 3 MM	Ø17 X 3 MM	Ø22 X 3 MM	Ø17 X 3 MM
GRADE	WHEEL	WHEEL	K/EDGE	K/EDGE
■ MEDIUM	21-2481	21-2483	21-2485	21-2487

Mounted Point

- Shank 3/32"

Bx/10



SIZE	Ø5.5 X 16.3 MM	Ø5 X 16 MM	Ø15 X 2.5 MM
GRADE	FLAME	BULLET	K/EDGE
■ MEDIUM	21-2491	21-2492	21-2493



75. Silicone Wheels

• Accurately graded silicon carbide impregnated wheels • Arbor hole is 1/16" • Speed 10,000 rpm

Bx/100

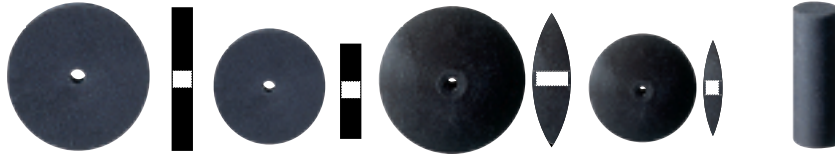

SIZE	Ø 7/8" X 1/8" X 1/16"	Ø 5/8" X 1/8" X 1/16"	Ø 7/8" X 1/8" X 1/16"	Ø 5/8" X 1/8" X 1/16"	1/4" X 7/8"
GRADE	SQ/EDGE	SQ/EDGE	K/EDGE	K/EDGE	CYL.
COARSE	21-2501	21-2505	21-2509	21-2513	21-2517
MEDIUM	21-2502	21-2506	21-2510	21-2514	21-2518
FINE	21-2503	21-2507	21-2511	21-2515	21-2519
X-FINE	21-2504	21-2508	21-2512	21-2516	21-2520

Mounted Silicone Points

• Shank 3/32" Sold bx/10



Ø 1/4" X 5/8"	Ø 1/4" X 1/2"
BULLET	CYL. MTD
21-2521	21-2525
21-2522	21-2526
21-2523	21-2527
21-2524	21-2528

76. Pumice Wheels

• For the absolute finest finish for all precious metals • Arbor hole is 1/16" • Speed 10,000 rpm

Bx/100



SIZE	Ø 7/8" X 1/8" X 1/16"	Ø 7/8" X 1/8" X 1/16"
GRADE	SQ/EDGE	K/EDGE
MEDIUM	21-2571	21-2573
FINE	21-2572	21-2574

77. Mounted Pumice Points

• For fine finish polishing of stone set jewelry • Shank 3/32" • Speed 10,000 rpm

Bx/10

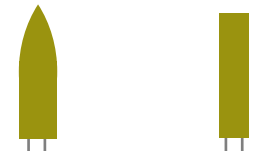

SIZE	Ø 1/4" X 1/2"	Ø 1/4" X 5/8"
GRADE	BULLET	CYL.MTD
MEDIUM	21-2581	21-2583
FINE	21-2582	21-2584



Selection Chart

	GRIT	APPLICATION
Coarse	220	Rapid Stock Removal
Medium	320	General Smoothing
Fine	800	Polishes and Shines

78. Superior Silicone Ultra Flex Wheels

• Unmounted wheels for a high shine on precious metals • Speed 5,000- max 10,000 rpm

Bx/100



SIZE	Ø 7/8" X 1/8" X 1/16"	Ø 3/4" X 1/8" X 1/16"
GRADE	SQ/EDGE	K/EDGE
FINE	21-2561	21-2563
X-FINE	21-2562	21-2564

79. Diamond Polishers for Platinum

• High performance diamond polishers for an ultra fine finish on platinum • Shank 3/32" • Speed 10,000 rpm



SIZE	Ø 5/8" X 1/8" X 1/16"	Ø 3/16" X 5/8"
GRADE	SQ/EDGE	BULLET
FINE	21-2591	21-2592

80. Unmounted Diamond Wheels

• Diamond impregnated polishers for pre-polish on precious metals • Speed 10,000 rpm



SIZE	Ø 7/8" X 1/16"	Ø 7/8" X 1/16"
GRADE	SQ/EDGE	K/EDGE
MEDIUM	21-2596	21-2597



ikohé 81. Rubberized Wheels

- **Green:** Silicon carbide "Medium" for scratch removal • **Red Flexies:** Aluminum oxide "Fine" for fast finishing of all metals
 - **White:** Aluminum oxide "X-fine" Ultra-fine polishing of gold and other precious metals • Arbor hole $-\frac{1}{16}$ " • Speed 5,000-max 15,000 rpm
- Bx/100

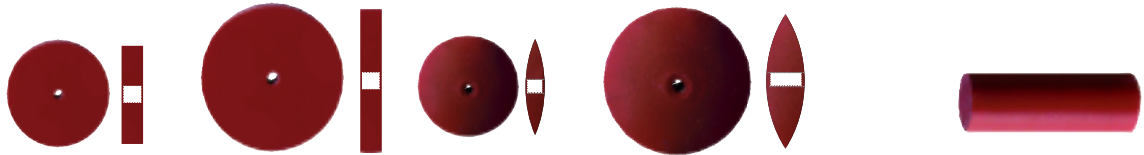

SIZE	$\varnothing \frac{5}{8}" \times \frac{1}{8}"$	$\varnothing \frac{7}{8}" \times \frac{1}{8}"$	$\varnothing \frac{5}{8}" \times \frac{1}{8}"$	$\varnothing \frac{7}{8}" \times \frac{1}{8}"$	$\varnothing \frac{1}{4}" \times \frac{7}{8}"$
GRADE	SQ/EDGE	SQ/EDGE	K/EDGE	K/EDGE	CLASP
MEDIUM -GRN	21-2531	21-2534	21-2537	21-2540	21-2546
FINE -RED	21-2532	21-2535	21-2538	21-2541	21-2547
X-FINE -WHITE	21-2533	21-2536	21-2539	21-2542	21-2548

Mounted Points

- **Green:** "Coarse" for scratch removal
- **Blue:** "Medium" for pre polishing
- **Red:** "Fine" for final finishing
- Speed 10,000-max 15,000 rpm
- Shank size $\frac{3}{32}$ "



Bx/10

GRADE	SIZE	$\varnothing \frac{1}{4}" \times \frac{5}{8}"$	$\varnothing \frac{1}{4}" \times \frac{5}{8}"$	$\varnothing \frac{1}{4}" \times \frac{1}{2}"$
GRADE	COLOR	POINT	BULLET	CYL.
COARSE (SiC)	GREEN	21-2551	21-2554	21-2557
MEDIUM (SiC)	BLUE	21-2552	21-2555	21-2558
FINE (SiC)	RED	21-2553	21-2556	21-2559



ikohé 82. Heatless Wheels

- Resin bonded hard heatless wheels can be shaped with a file or dresser • Achieves cutting without heat generation
- **Silicon carbide-** Color gray
- Arbor hole $-\frac{1}{16}$ " • Speed 20,000 rpm

Bx/50

T	$\frac{1}{2}" \varnothing$	$\frac{5}{8}" \varnothing$	$\frac{3}{4}" \varnothing$	$\frac{7}{8}" \varnothing$	1" \varnothing
$\frac{1}{16}"$	21-2601	21-2604	21-2607	21-2610	21-2613
$\frac{1}{8}"$	21-2602	21-2605	21-2608	21-2611	21-2614
$\frac{3}{16}"$	21-2603	21-2606	21-2609	21-2612	21-2615

- **Aluminum Oxide-**Color white
- Arbor hole $-\frac{1}{16}$ " • Speed 20,000 rpm

Bx/50

T	$\frac{1}{2}" \varnothing$	$\frac{5}{8}" \varnothing$	$\frac{3}{4}" \varnothing$	$\frac{7}{8}" \varnothing$	1" \varnothing
$\frac{1}{16}"$	21-2621	21-2624	21-2627	21-2630	21-2633
$\frac{1}{8}"$	21-2622	21-2625	21-2628	21-2631	21-2634
$\frac{3}{16}"$	21-2623	21-2626	21-2629	21-2632	21-2635



Silicon Carbide- Gray



Aluminum Oxide- White

83. Gem Shine Wheels - for Stone Set Jewelry

- Polishing felt impregnated with diamond polishing paste
- Imparts a brilliant shine on precious and semi-precious stones
- Arbor hole $\frac{1}{16}$ " • Comes with five wheels and mandrel • Speed 15,000 rpm

ITEM #	DESCRIPTION
21-2685	GEM POLISHING WHEELS (5 PCS WITH MANDREL)





84. Ceraton- Ceramic Glass Fiber Polishers- Japan

- Unique, superb polishing innovation
- Combines ceramic and glass fibers in a thermosetting resin
- Versatile applications for jewelry, gold, silver, platinum and precious metal alloys
- Useful for polishing jewelry with set stones
- Size Ø X L (2.35 X 50mm)
- Speed 10,000- max 20,000 rpm



The Advantage of Ceramic Glass Fiber Polishers for stone set jewelry

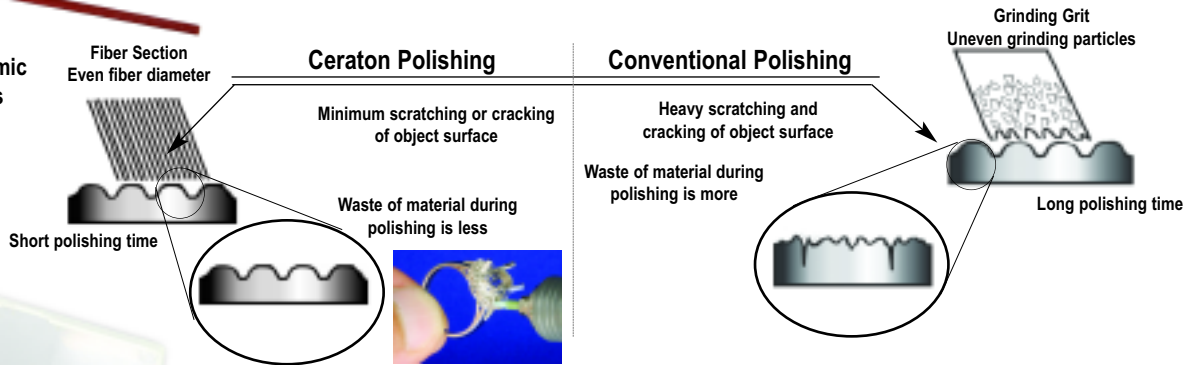

ITEM #	COLOR	GRIT
21-2671	BROWN	180
21-2672	ORANGE	250
21-2673	BLACK	280
21-2674	DK.BLUE	360
21-2675	BLUE	400

ITEM #	COLOR	GRIT
21-2676	GREEN	500
21-2677	YELLOW	700
21-2678	PINK	1000
21-2679	RED	1200
21-2680	SET OF 9 PCS ONE EA.	

85. MITCHELLS Abrasive Tapes

- Tapes are impregnated on both sides and will not fray or tear
- Can be cut to any length
- Ideal for narrow slots and grooves
- Useful to debur, grind and polish

50' Spool (15 meters)

TAPE	TYPE	ITEM #	STYLE	W X T	GRIT
—	ALO	21-1601	56	0.093" X 0.037"	180
		21-1602	57	0.125" X 0.030"	180
—	CROCUS	21-1603	56-C	0.093" X 0.030"	180

Abrasive Cords

- Effective on hard and soft metals, ceramic, plastic and wood
- Can be used on jewelers saw frames
- Extremely flexible, useful for intricate settings, under bezels and hard to reach areas

50' Spool (15 meters)

CORD	TYPE	ITEM #	STYLE	Ø	GRIT
●	ALO	21-1604	49	0.082"	120
		21-1605	50	0.070"	180
		21-1606	51	0.055"	120
		21-1607	53	0.040"	180
		21-1608	54	0.030"	200
●	SIC	21-1611	54-HS	0.025"	200
		21-1612	55 S	0.018"	200
		21-1613	60 S	0.015"	200
		21-1614	66 S	0.012"	280
●	CROCUS	21-1617	52-C	0.055"	ULTRA-FINE
		21-1618	53-C	0.040"	ULTRA-FINE
		21-1619	54-C	0.030"	ULTRA-FINE
		21-1620	54-HC	0.025"	ULTRA-FINE
		21-1621	55-C	0.018"	ULTRA-FINE
		21-1622	60-C	0.015"	ULTRA-FINE
		21-1623	66-C	0.012"	ULTRA-FINE

APPLICATION

Tapes replace emery cloth strips.
Cords reach inside very fine holes.





86. Cone-Loc Drum Sander for Shop Rolls

- Precision machined aluminum rubber lined drum sander
- For contour sanding and sprue removal
- Drum accepts abrasive cloth strip
- Use on bench polishers with 1/2" arbor



ITEM #	DESCRIPTION	Ø X T X AH
21-2771	DRUM SANDER	6" X 1 1/2" X 1/2"
21-2772	DRUM SANDER	6" X 2" X 1/2"

87. Aluminum Back Plate for Split Lapping

- Precision flat aluminum back plate similar to split lap
- Use for 6" or 8" PSA abrasive disc
- Suitable for split lap machine

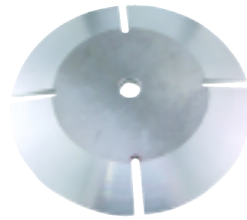

ITEM #	DESCRIPTION	Ø X HOLE
21-2775	BACK PLATE	6" X 5/8"
21-2776	BACK PLATE	8" X 5/8"

88. Arbor & Flange-Straight

- Use for straight motor shaft of polishing machines
- For large wheels with 12.7mm (1/2") arbor hole



ITEM #	DESCRIPTION	D Ø
42-1361	ARBOR- STRAIGHT	1/2" LH
42-1362	ARBOR- STRAIGHT	1/2" RH
42-1363	ARBOR- STRAIGHT	5/8" LH
42-1364	ARBOR- STRAIGHT	5/8" RH

• RH - Right Hand, LH- Left hand

89. Split Wood Mandrel

- Hardwood mandrel with slot to bind emery paper or cloth
- Fits on the tapered end of polishing spindles



ITEM #	DESCRIPTION	TYPE
21-2741	WOOD MANDREL	STRAIGHT
21-2742	WOOD MANDREL	TAPERED

90. Expandable Drum Arbors

- Steel arbors with a solid synthetic rubber drum
- Expands evenly to hold sanding bands
- Cushioned backing for a smooth cut and uniform finish

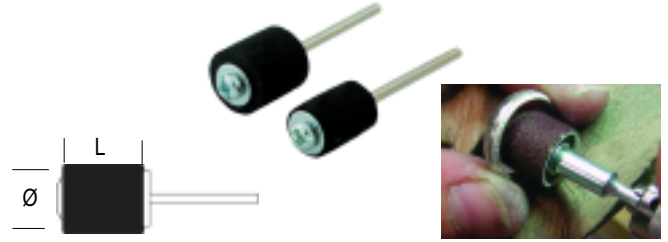

ITEM #	Ø X L	SHANK
21-2751	1/4" X 1/2"	3/32"
21-2752	1/2" X 1/2"	3/32"
21-2754	1/2" X 1"	3/32"
21-2757	3/8" X 1/2"	3/32"
21-2761	1/4" X 1/2"	1/8"
21-2762	1/2" X 1/2"	1/8"
21-2764	1/2" X 1"	1/8"

91. Inside Ring Mandrel

- Inside ring cylinder mandrel
- Use for inside ring polishers pg# 15

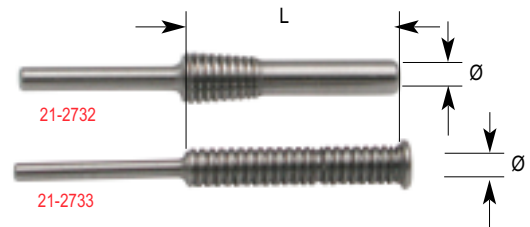

ITEM #	SHANK	PILOT Ø X L
21-2732	1/8"	3/16" X 1"
21-2733	3/32"	3/16" X 1"

92. Mandrels-Cartridge Roll

- Steel mandrels for abrasive cartridge rolls
- Pilot guides roll for absolute true running

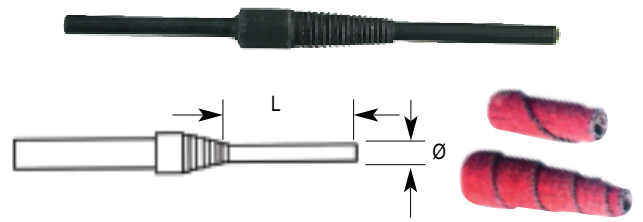

ITEM #	SHANK	PILOT Ø X L
21-2727	3/32"	1/8" X 3/4"
21-2728	1/8"	1/8" X 1"

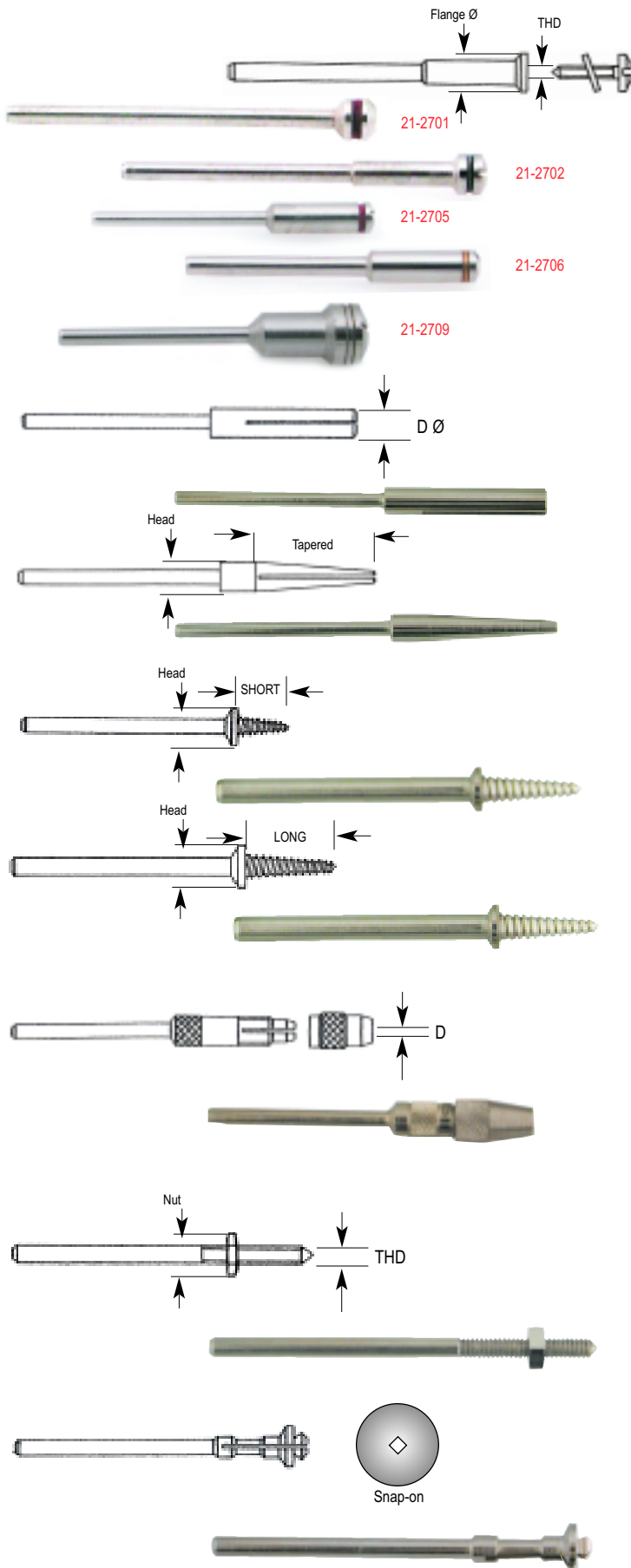

93. Mandrels-Screw

- Mandrels for abrasive wheels, cutting discs and bristle brushes
 - Use in flexshaft handpiece • Thread ends are right handed
- Bx/12**

ITEM #	SHANK	HEAD Ø	THD.
21-2701	3/32"	3/16"	1/16"
21-2702	3/32"	3/16"	1/16"
21-2705	3/32"	3/16"	1/16"
21-2706	1/8"	3/16"	1/8"
21-2709	1/8"	7/16"	1/4"

94. Mandrels-Split

- Mandrel with slot to grip abrasive paper or cloth
 - Build a suitable diameter for inside finishing
- Bx/12**

ITEM #	SHANK	HEAD Ø	TYPE
21-2711	3/32"	9/64"	STRAIGHT
21-2712	3/32"	11/64"	STRAIGHT
21-2714	3/32"	3/16"	TAPERED

95. Mandrels-Screw Taper

- Designed for felt buffs, wheels, cylinders and points
 - Threads are right handed • Use for wheels with 1/6" arbor hole
- Bx/12**

ITEM #	SHANK	HEAD Ø	TYPE
21-2716	3/32"	3/16"	SHORT
21-2717	1/8"	3/16"	SHORT
21-2718	3/32"	3/16"	LONG
21-2719	1/8"	3/16"	LONG

96. Mandrels-Pin Chuck

- Chuck mandrel for silicone pins • Pins can be held at various lengths
- Bx/12**

ITEM #	SHANK	D Ø	TYPE
21-2721	3/32"	2MM	PIN CHUCK
21-2722	3/32"	3MM	PIN CHUCK

97. Mandrels-Thread with Nut

- Use for through or blind holes in cylinders • Thread ends are right handed
- Bx/12**

ITEM #	SHANK	NUT	THD.
21-2725	3/32"	3/16"	3/32"
21-2726	1/8"	3/16"	3/32"

98. Mandrels-Snap-on

- One piece construction with a snap-on end
 - Square drive is positive and avoids slippage
- Bx/12**

ITEM #	SHANK	HEAD Ø
21-2731	3/32"	SQ/DRIVE



NORTON 99. India Combination Stones

- Aluminum oxide stones provide a keen cutting edge on gravers and other tools
- Lubricate with a light oil • One side coarse and the other fine

ITEM #	SIZE	GRADE
21-2801	6" X 2" X 1"	COARSE/FINE
21-2802	8" X 2" X 1"	COARSE/FINE

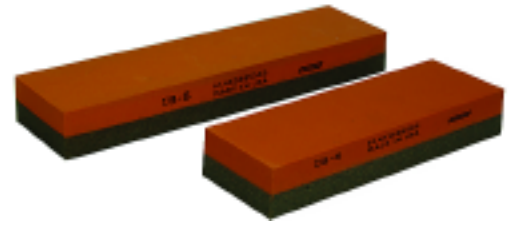

NORTON 100. India Oil Stones

- Superior grade aluminum oxide
- Enhances cutting edges on knives, chisels, gravers and other precision tools
- Lubricate with a light oil smear to eliminate swarf build up during use

ITEM #	SIZE	GRADE	ITEM #	SIZE	GRADE
21-2807	4" X 1" X 1/2"	MEDIUM	21-2810	6" X 2" X 1"	FINE
21-2808	4" X 1" X 1/2"	FINE	21-2811	8" X 2" X 1"	MEDIUM
21-2809	6" X 2" X 1"	MEDIUM	21-2812	8" X 2" X 1"	FINE
21-2816	WOOD BOX- 21-2807/08		21-2815	WOOD BOX- 21-2809/10	



NORTON 101. India Shaped Stones

- Hard tough aluminum oxide in special shapes
- Use for sharpening or smoothing tools, dies, blades or molds
- Lubricate with a light oil

ITEM #	SHAPES	LENGTH	SIZE	GRADE
21-2871	ROUND	4"	3/8"	MEDIUM
21-2874	ROUND	4"	1/4"	MEDIUM
21-2877	SQUARE	4"	3/8"	MEDIUM
21-2878	SQUARE	4"	1/4"	MEDIUM

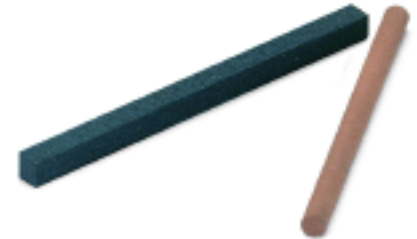

102. Ruby Bench Stones

- Pure synthetic ruby crystals • Outstanding wear resistance
- Speciality stone for polishing pivots and crystals • Use with or without light oil lubrication

Both sides finished.

ITEM #	SIZE	GRADE
21-2851	4" X 1" X 3/8"	MEDIUM
21-2852	4" X 1" X 3/8"	FINE

One side finished

ITEM #	SIZE	GRADE
21-2853*	4" X 1" X 3/8"	MEDIUM
21-2854*	4" X 1" X 3/8"	FINE
21-2858*	4 3/4" X 2" X 3/8"	MEDIUM
21-2859*	4 3/4" X 2" X 3/8"	FINE

**Comes in a wooden box.*



103. 3M® Diamond Whetstones

- A superb flat surface coated with micron diamond abrasives
- Achieve a mirror like finish on carbide gravers • Lubricate lightly with water

ITEM #	SIZE	MIC.	ITEM #	SIZE	MIC.
21-2861	4" X 1"	125	21-2866	6" X 1"	125
21-2862	4" X 1"	74	21-2867	6" X 1"	74
21-2863	4" X 1"	40	21-2868	6" X 1"	40
21-2864	4" X 1"	20			

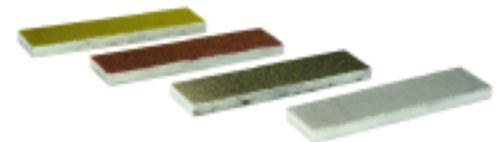



104. Sharpening Stones- Diamond

- Diamond sharpening stones are designed to fine finish the edges of gravers, screwdrivers and tools
- A sharper stronger tool edge achieves cleaner lines and brighter cuts • Lubricate with water

ITEM #	SIZE	GRADE	GRIT
21-2841	6" X 2" X 1/4"	FINE	600
21-2842	6" X 2" X 1/4"	X-FINE	1200

105. Original Arkansas Stones

- Natural Arkansas stones are excellent for sharpening and final honing of gravers
- Each stone comes in a hardwood box
- Lubricate with a light oil for rapid cutting

ITEM #	SIZE	GRADE	ITEM #	SIZE	GRADE
21-2821	4" X 2" X 1/2"	HARD	21-2824	6" X 2" X 1/2"	EX-HARD
21-2822	4" X 2" X 1/2"	EX-HARD	21-2825	8" X 2" X 1/2"	HARD
21-2823	6" X 2" X 1/2"	HARD	21-2826	8" X 2" X 1/2"	EX-HARD

106. Imported Arkansas Stones

- Hard grades are dense-grained for final sharpening
- Dimension in MM

ITEM #	SIZE	GRADE	ITEM #	SIZE	GRADE
21-2831	100 X 40 X 12	HARD	21-2837	150 X 50 X 18	HARD
21-2832	100 X 50 X 12	HARD	21-2838	175 X 50 X 18	HARD
21-2835	125 X 50 X 18	HARD	21-2839	200 X 50 X 18	HARD
21-2836	150 X 40 X 18	HARD			

Stone Selection for Sharpening

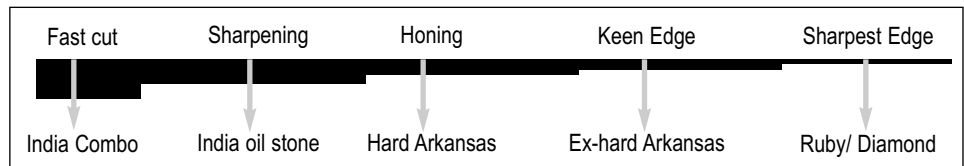

NORTON 107. Oil

- Specially formulated lubricant
- Use on sharpening stones
- Eliminates swarf build up

ITEM #	DESCRIPTION
21-2891	4 1/2 OZ
21-2892	8 OZ

109. Graver Sharpener

- Secure the graver in the opening and adjust the angle as desired
- Rolls across the oil stone during sharpening

For gravers
see page # 176-182



ITEM #	DESCRIPTION
37-2052	GRAVER SHARPENER

108. Crocker Pattern-Graver Sharpener

- Precision fixture to assist sharpening of gravers on bench stones
- Accurate angle and index settings

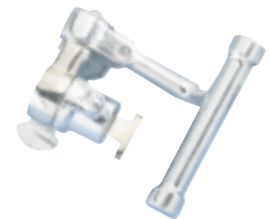

ITEM #	DESCRIPTION
37-2051	GRAVER SHARPENER

- Graver is positioned in either of the two angled openings
- Roll over flat oil stone for sharpening
- Size 1 3/4" X 1 1/2"



ITEM #	DESCRIPTION
37-2053	GRAVER SHARPENER



BEADING

■ Arabic Gum	31
■ Bead Awls	31
■ Bead Boards	31
■ Bead Reamer Set	32
■ Books	29
■ Crimp- Beads	29
■ Crimp- Tubes	29
■ Griffin Craft Wire	29
■ Griffin Jewelry Elastic Cord (Stretch Magic) Clear	29
■ Griffin Jewelry Silk on Spools	28
■ Griffin Jewelry Silk Bead Cord	28
■ Griffin Natural Nylon Bead Cord	31
■ Griffin Polyamide (NYLON) Bead Cord	31
■ Mighty Mag Illuminated Magnifier	31
■ Mini Bench Vise	31
■ Needle	31
■ OptiVISOR® LX	30
■ Pliers	30
■ Soft Flex® 24K Gold Flex Wire™	30
■ Soft Flex® Beading Wire	30
■ Soft Touch™ Silver	31
■ Tri-Cord Knotting Tool	31
■ Wire Rounder	31

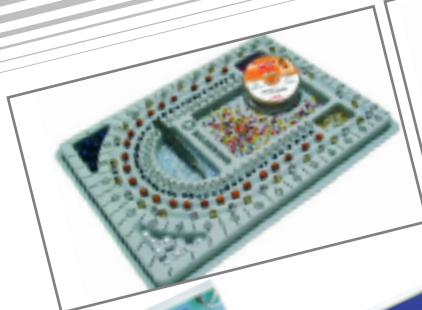
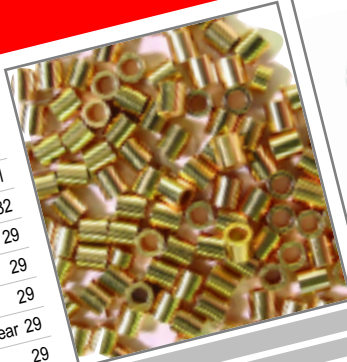

BOOKS

ikohe



33. Advanced Beadwork by Ruth F. Poris

An indispensable book for anyone interested in beadwork. A classic teaching manual. Explores all of the major beading techniques. Provides information on metalworking, findings, tools and supplies that are needed for stringing beads. Over 300 illustrations and photos.

61-1252 (Softcover – 146 pages)

BEADING



Top quality German made Griffin bead cord in brilliant colors. Ready to use right off the card. No threading the needle or doubling the cord. Gets your work done fast!!

1. Natural Silk Bead Cord- Carded

Natural silk has very good tensile strength, does not stretch much and can be worked or knotted easily. Soft, smooth and supple, it adapts to the shape of the body.

Available on card with needle - 6.5 ft (2M) of thread. Each pack contains 5 individual cards.



		Natural Silk with 1 Needle 2m						
		#0 0.30MM	#1 0.35MM	#2 0.45MM	#3 0.50MM	#4 0.60MM	#6 0.70MM	#8 0.80MM
WHITE		22-101-00	22-101-01	22-101-02	22-101-03	22-101-04	22-101-06	22-101-08
PINK		-	-	22-102-02	22-102-03	22-102-04	22-102-06	22-102-08
DK. PINK		-	-	22-103-02	22-103-03	22-103-04	22-103-06	22-103-08
CORAL		-	-	22-104-02	22-104-03	22-104-04	22-104-06	22-104-08
RED		-	-	-	22-105-03	22-105-04	22-105-06	22-105-08
GARNET		-	-	22-106-02	22-106-03	22-106-04	22-106-06	22-106-08
YELLOW		-	-	-	-	22-107-04	22-107-06	22-107-08
AMBER		-	-	22-108-02	22-108-03	22-108-04	22-108-06	22-108-08
BLUE		-	-	22-109-02	22-109-03	22-109-04	22-109-06	22-109-08
DK. BLUE		-	-	-	-	22-110-04	22-110-06	22-110-08
LILAC		-	-	-	-	22-111-04	22-111-06	22-111-08
AMETHYST		-	-	22-112-02	22-112-03	22-112-04	22-112-06	22-112-08
TURQUOISE		-	-	22-113-02	22-113-03	22-113-04	22-113-06	22-113-08
JADE		-	-	22-114-02	22-114-03	22-114-04	22-114-06	22-114-08
GREEN		-	-	22-115-02	22-115-03	22-115-04	22-115-06	22-115-08
CORNELIAN		-	-	22-116-02	22-116-03	22-116-04	22-116-06	22-116-08
BEIGE		-	-	22-117-02	22-117-03	22-117-04	22-117-06	22-117-08
BROWN		-	-	22-118-02	22-118-03	22-118-04	22-118-06	22-118-08
GRAY		22-119-00	22-119-01	22-119-02	22-119-03	22-119-04	22-119-06	22-119-08
BLACK		-	-	22-120-02	22-120-03	22-120-04	22-120-06	22-120-08

2. Polyamid (NYLON) Bead Cord- Carded

Polymide thread is stronger than "Natural Silk". Under tension it stretches but returns to its original dimensions when released. This is advantageous as it allows you to precisely position the knots.

Available on card with needle - 6.5 ft (2M) of thread. Each pack contains 5 individual cards.



SIZE	Ø
№. 0	~0,30 mm
№. 1	~0,35 mm
№. 2	~0,45 mm
№. 3	~0,50 mm
№. 4	~0,60 mm
№. 5	~0,65 mm
№. 6	~0,70 mm
№. 7	~0,75 mm
№. 8	~0,80 mm
№. 10	~0,90 mm

Nylon-Polyamide with 1 Needle 2m

		#2 0.45MM	#4 0.60MM	#6 0.70MM	#8 0.80MM	#10 0.90MM
WHITE		22-131-02	22-131-04	22-131-06	22-131-08	22-131-10
PINK		22-132-02	22-132-04	22-132-06	22-132-08	22-132-10
DK. PINK		22-133-02	22-133-04	22-133-06	22-133-08	22-133-10
CORAL		22-134-02	22-134-04	22-134-06	22-134-08	22-134-10
RED		22-135-02	-	22-135-06	22-135-08	22-135-10
GARNET		22-136-02	22-136-04	22-136-06	22-136-08	22-136-10
YELLOW		22-137-02	22-137-04	22-137-06	22-137-08	22-137-10
AMBER		22-138-02	22-138-04	22-138-06	22-138-08	22-138-10
BLUE		22-139-02	22-139-04	22-139-06	22-139-08	22-139-10
DK. BLUE		22-140-02	22-140-04	22-140-06	22-140-08	22-140-10
LILAC		22-141-02	22-141-04	22-141-06	22-141-08	22-141-10
AMETHYST		22-142-02	22-142-04	-	-	22-142-10
TURQUOISE		22-143-02	22-143-04	-	-	22-143-10
JADE		22-144-02	22-144-04	22-144-06	22-144-08	22-144-10
GREEN		-	22-145-04	22-145-06	22-145-08	22-145-10
CORNELIAN		22-146-02	22-146-04	22-146-06	22-146-08	22-146-10
BEIGE		22-147-02	22-147-04	22-147-06	22-147-08	22-147-10
BROWN		22-148-02	22-148-04	22-148-06	22-148-08	22-148-10
GRAY		22-149-02	22-149-04	22-149-06	22-149-08	22-149-10
BLACK		22-150-02	22-150-04	22-150-06	22-150-08	-

How to Thread a bead Necklace

By Griffin 22-0095

This book describes bead stringing methods with numerous diagrams and explanations. Ideal for the beginner to acquire the art of beading.



3. 100% Jewelry Silk on Spools

Griffin made high quality 100% silk thread. Very strong, supple and soft. Absolutely no stretch. Excellent for stringing semi-precious stone beads, delicate beads and pearls. Available in eight sizes and twelve colors, 8g spools.

	Ø MM L	0.15 310M	0.20 200M	0.27 135M	0.30 90M	0.33 80M	0.35 65M	0.38 50M	0.42 40M
WHITE		22-171-01	22-171-02	22-171-03	22-171-04	22-171-05	22-171-06	22-171-07	22-171-08
LT. PINK		-	-	-	-	22-172-05	22-172-06	22-172-07	22-172-08
CORAL		-	-	-	-	22-173-05	22-173-06	22-173-07	22-173-08
GARNET		-	-	-	-	22-174-05	22-174-06	22-174-07	22-174-08
YELLOW		-	-	-	-	22-175-05	22-175-06	22-175-07	22-175-08
DK. BLUE		-	-	-	-	22-176-05	22-176-06	22-176-07	22-176-08
AMETHYST		-	-	-	-	22-177-05	22-177-06	22-177-07	22-177-08
TURQUOISE		-	-	-	-	22-178-05	22-178-06	22-178-07	22-178-08
JADE GREEN		-	-	-	-	22-179-05	22-179-06	22-179-07	22-179-08
BROWN		-	-	-	-	22-180-05	22-180-06	22-180-07	22-180-08
GRAY		-	-	-	-	22-181-05	22-181-06	22-181-07	22-181-08
BLACK		22-182-01	22-182-02	22-182-03	22-182-04	22-182-05	22-182-06	22-182-07	22-182-08



4. Jewelry Elastic Cord (Stretch Magic) Clear

- Superior quality elastic cord for beading
- Clear, long lasting & chemical resistant
- Available in three diameters



SPOOL LENGTH 5 M			SPOOL LENGTH 25 M		
0.5 MM Ø	0.7 MM Ø	1.0 MM Ø	0.5 MM Ø	0.7 MM Ø	1.0 MM Ø
22-153-01	22-153-02	22-153-03	22-153-04	22-153-05	22-153-06

5. Craft Wire

- Griffin made high quality craft wire
- A value priced bead stringing wire
- Copper based wire plated in silver & gold
- Available in spools



Ø	Description	Item #
0.25MM	SILVER PLATED - 35 M	22-185-01
0.40MM	SILVER PLATED - 15 M	22-185-02
0.60MM	SILVER PLATED - 10 M	22-185-03
0.80MM	SILVER PLATED - 6 M	22-185-04
1.00MM	SILVER PLATED - 4 M	22-185-05
0.25MM	GOLD PLATED - 35 M	22-186-01
0.40MM	GOLD PLATED - 15 M	22-186-02
0.60MM	GOLD PLATED - 10 M	22-186-03
0.80MM	GOLD PLATED - 6 M	22-186-04
1.00MM	GOLD PLATED - 4 M	22-186-05

6. Crimp-Tubes-Gold & Silver

Top quality crimp tubes made in sterling silver and sterling silver-gold plated. Highly polished tubes with ample wall thickness.

Available in boxes of 100 pieces.

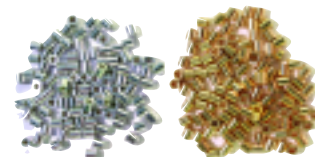

Tube Ø	Description	Item #
0.70 / 1.8 MM	925 Sterling Silver-Sm	22-190-01
1.00 / 2.00MM	925 Sterling Silver-Med	22-190-02
1.20 / 2.20MM	925 Sterling Silver-Lg	22-190-03
0.70 / 1.8 MM	925 St.Silver-Gold Plated Sm	22-191-01
1.00 / 2.00MM	925 St.Silver-Gold Plated Med.	22-191-02
1.20 / 2.20MM	925 St.Silver-Gold Plated Lg	22-191-03

7. Crimp- Beads

Top quality beads made in sterling silver and sterling silver -gold plated. Seamless finish with ample thickness prevents breaking.

Available in boxes of 100 pieces.

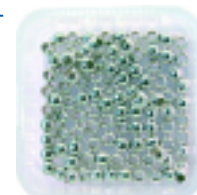

Bead Ø	Description	Item #
0.80 / 1.8 MM	925 Sterling Silver-Sm	22-192-01
1.20 / 2.50MM	925 Sterling Silver-Lg	22-192-02
0.80 / 1.8 MM	925 St.Silver-Gold Plated Sm	22-193-01
1.20 / 2.50MM	925 St.Silver-Gold Plated Lg.	22-193-02



8. Soft Flex® Beading Wire

The designers choice in bead stringing materials! Soft Flex wire is brought to you by a state of the art micro-wire technology. It is the most flexible, knittable stainless steel wire designed to handle all levels of abrasion, everything from soft materials like pearls and seed beads to rougher materials like glass, minerals and metal. A range of vibrant colors to open up a whole new world for designers.

Available in spools of three diameters and two lengths.

0.014 Ø (21 strand) Use with softer, less abrasive materials, pearls and seed beads.

0.019 Ø (49 strand) Ideal for use with glass beads, Austrian crystals, silver and pewter.

0.024 Ø (49 strand) Great for use multi-standard designs, African beads and large stones.

Spools	30 ft			100 ft		
	0.014	0.019	0.024	0.014	0.019	0.024
CLEAR	22-200-01	22-200-02	22-200-03	22-200-04	22-200-05	22-200-06
BLACK	22-201-01	22-201-02	22-201-03	22-201-04	22-201-05	22-201-06
WHITE	22-202-01	22-202-02	22-202-03	22-202-04	22-202-05	22-202-06
RED	22-203-01	22-203-02	22-203-03	22-203-04	22-203-05	22-203-06
YELLOW	22-204-01	22-204-02	22-204-03	22-204-04	22-204-05	22-204-06
BLUE	22-205-01	22-205-02	22-205-03	22-205-04	22-205-05	22-205-06
GREEN	22-206-01	22-206-02	22-206-03	22-206-04	22-206-05	22-206-06
PURPLE	22-207-01	22-207-02	22-207-03	22-207-04	22-207-05	22-207-06
TURQUOISE*	22-208-01	22-208-02	22-208-03	22-208-04	22-208-05	22-208-06
PINK	22-209-01	22-209-02	22-209-03	22-209-04	22-209-05	22-209-06

* TURQUOISE

9. Soft Touch™ Silver

Soft touch is once again redefining flexibility. Constructed from micro-woven stainless steel wire strands it offers 50% more suppleness, more life and movement to your jewelry designs. Eliminate the frustrating task of re-stringing due to cutting and breakage by selecting the appropriate wire diameter. The thicker the wire the better resistance it will have against breakage.

Available in spools of 30 ft and 100 ft.

Spools	30 ft			100 ft		
	0.014	0.019	0.024	0.014	0.019	0.024
Silver	22-220-01	22-220-02	22-220-03	22-220-04	22-220-05	22-220-06

10. Soft Flex® 24K Gold Flex Wire™

Soft Flex is changing the way your designs look with a new supple, flexible wire that is easy to knot. 24k Gold coated micro-woven stainless steel wires result in a premium quality beading wire for professionals. It will look rich and beautiful when strung with clear, translucent beads and gold findings.

Available in spools of 30 ft and 100 ft.

Spools	30 ft			100 ft		
	0.014	0.019	0.024	0.014	0.019	0.024
Gold 24K	22-221-01	22-221-02	22-221-03	22-221-04	22-221-05	22-221-06



11. Bead Awls

Fine quality beading awls with hard wood handles and very fine points. Use for knotting, picking and twining.



ITEM #	DESCRIPTION
22-0010	STRINGING AWLS 6"
22-0011	KNOTTING AWLS 6"

12. Bead Reamer Set

A perfect tool to smoothe or enlarge bead holes. Features six different shaped ends.

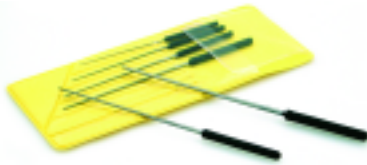

ITEM #	DESCRIPTION
22-0014	BEAD REAMER SET

13. Tri-Cord Knotting Tool

Make perfect knots everytime. A very functional tool that lets you space beads perfectly and tie consistent knots easily.

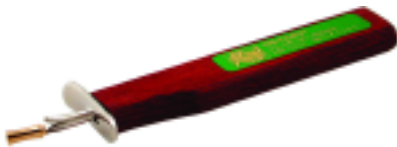

ITEM #	DESCRIPTION
22-0016	TRI-CORD TOOL

14. Wire Rounder

A great tool to round wire ends after cutting. Uses a 1.8 cup bur that leaves the wire end rounded.



ITEM #	DESCRIPTION
22-0019	WIRE ROUNDER

15. Needle

Griffin made high quality needles are available in three sizes. Measures approximately 4" long, each with a collapsible eye.



ITEM #	DESCRIPTION
22-195-01	0.095" - FINE PK/25
22-195-02	0.14" - MEDIUM PK/25
22-195-03	0.20" - HEAVY PK/25

16. Arabic Gum

Useful to seal thread ends and knots. Water soluble. 1/2 fl. oz.



ITEM #	DESCRIPTION
22-0021	ARABIC GUM

17. Mini Bench Vise

A light duty bench vise for innumerable small jobs. Instantly clamps to your workbench when needed.



ITEM #	DESCRIPTION
22-0024	MINI BENCH VISE

18. Bead Boards

High quality flocked bead boards. Two favorite designs for all your beading needs.

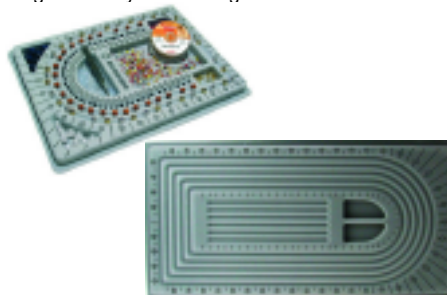

ITEM #	DESCRIPTION
22-0031	SMALL BOARD -13 1/2" X 9"
22-0032	MULTI STRAND-21 1/2" X 10 1/2"

19. Lap Joint Pliers-Value

Well crafted stainless steel pliers in various nose shapes. All with lap joints, spring and PVC coated handles.



ITEM #	DESCRIPTION
41-1261	5 PCS SET

20. BeadSmith Magical Crimp Forming Tool

Transforms 2mm Tubular Crimps into Round Beads! This unique, patented tool was created exclusively for use with 2mm sterling silver or gold-filled tubular crimp beads and 0.014-0.015" (#PL940/#ER940) or 0.018-0.019" diameter flex wire. Just a few easy steps will form a 2mm crimp into a more appealing round bead!

- No sharp edges! No crimp covers!
- Professional finish
- Secure, quick and easy
- Available with standard or ergonomic handles



ITEM #	DESCRIPTION
22-0051	CRIMP F/TOOL 0.14-0.15"
22-0052	CRIMP F/TOOL 0.18-0.19"

21. Plastic Organizers

Clear hinged storage container with fixed compartments to organize beads and findings.

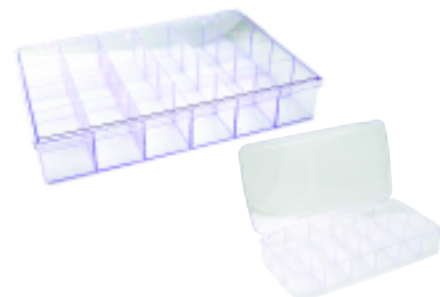

ITEM #	DIMENSIONS
22-0071	7" X 3 1/2" X 1 1/4"
22-0072	11" X 6 3/4" X 1 1/4"



1. The Design and Creation of Jewelry

by **Robert Von Neumann**

A complete reference guide showing traditional and contemporary methods and materials of jewelry making. Learn basic and specialized metalworking, shaping and decorative techniques. Covers cutting, stamping, pickling, coloring, polishing and design transfer methods.

61-1011 (Softcover – 321 pages)

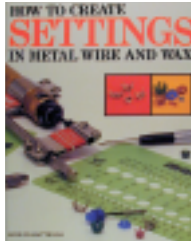

2. How to Create Settings In Metal Wire and Wax

by **Adolfo Mattiello**

Contains over 250 diagrams for creating settings in metal, wire and wax. Well-illustrated, detailed directions guide you through the procedures of various settings including regular wire settings, slim-line wire settings, wax settings, special wax settings and joining settings to form a cluster.

61-1012 (Softcover – 33 pages)

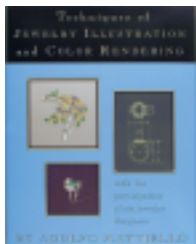

3. Techniques of Jewelry Illustration and Color Rendering

by **Adolfo Mattiello**

Beautifully illustrated guide to jewelry rendering. Some of the best jewelry designers in the field explain and demonstrate the illustration process.

61-1013 (Hardcover – 152 pages)

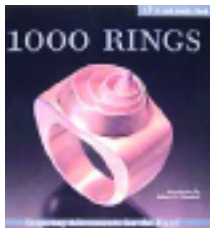

4. 1000 Rings - Inspiring Adornments for the Hand

A truly exquisite collection of color photographs of each of the ring designs along with comments of top artists working in the field. Some of the rings are constructed of conventional jewelry making material while others use unorthodox components. Many incorporate humour and surprise.

61-1014 (Softcover – 416 pages)



5. Jewelry Making For Schools, Tradesmen, Craftsmen (Revised Edition)

by **Murray Bovin; Revised by Peter M. Bovin**

A comprehensive, well-illustrated, easy-to-follow reference guide for the beginner and advanced craftsman. Covers practical and contemporary methods of jewelry making such as casting, stone setting, jewelry construction and decorative processes.

61-1015 (Spiralbound – 288 pages)



6. Jewelry

Concepts and Technology

by **Oppi Untracht**

The most thorough reference book available on traditional and innovative jewelry-making techniques. Features contemporary works from over 300 jewelers. 900 photos, 377 illustrations, step-by-step instructions, comprehensive glossary and a detailed index. A must-have book.

61-1016 (Hardcover – 840 pages)



7. The Jeweler's Art

by **Alice Sprintzen**

This book is designed as a working notebook for recording your discoveries, triumphs and corrections, for future reference. Explores design possibilities, hand tools, metals, sawing, filing, forming, soldering hinges and catches, finishing and buffing, stone setting and gem stones. Detailed step-by-step black & white line art instruction included.

61-1021 (Hardcover – 132 pages)



8. Jewelry:

Contemporary Design and Technique

by **Chuck Evans**

Solid introduction to creating handmade jewelry and other metal objects. Clear demonstrations of over 65 metalworking techniques. 365 photos and illustrations. Learn standard techniques, as well as specialized tasks including anodizing aluminum and titanium.

61-1018 (Hardcover – 267 pages)



9. Practical Jewelry Making

by **Loosli/Merz/Schaffner**

A comprehensive book providing practical, instructional knowledge for proficiency in the jewelry trade. Extensive coverage of basic operations including filing, sawing, soldering and drilling. Complex forming, assembling, setting and finishing operations are also covered.

61-1019 (Hardcover – 164 pages)



10. Jewelry – Two Books in One

by **Madeline Coles**

A unique instructional book with die-cut pages devoted to 23 outstanding projects. The top of each page illustrates each project and the bottom of each page discusses the appropriate techniques required to complete your work. Explanations of 20 techniques including cutting, sawing, drilling, filing, polishing, soldering, wire twisting, mitering, stone setting and more.

61-1020 (Hardcover – 128 pages)



11. Jeweler's Resource

by **Bruce G. Knuth**

A practical tool for the bench jeweler, student and retail jeweler. Easy-to-follow text and illustrations. Contains an extensive list of gems and gem properties; diagrams of gem-cutting styles; legal standards for diamond, gold and silver marketing; formulas and chemical preparations; and measurement conversion and comparison tables.

61-1031 (Spiral bound – 112 pages)

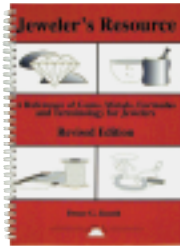

16. The Rings Book

by **Jinks Mcgarth**

Everything you need to know about the history of rings. All about the properties of metal, the tools to use, as well as the various processes, shaping, annealing, soldering and decorating.

61-1041 (Softbound 128 pages)

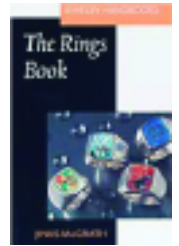

12. The Jeweler's Bench Reference

by **Harold O'Connor**

A handy pocket-size reference guide that explains all types of jewelry making techniques. Vital information on fabricating, soldering, stone-setting, plating and casting.

61-1032 (Spiral bound – 68 pages)



17. The Creative Jeweler

by **S. McSwiney, P. Williams, C. Davies & J. Davies**

A full color book with projects on earrings, bangles, brooches, necklaces and various other articles of jewelry. Lists a range of equipment and materials that are needed for this creative art form.

61-1042 (Softbound 160 pages)



13. The Flexible Shaft Machine

by **Harold O'Connor**

A quick reference guide that helps you save time and increase efficiency. Details the various abrasives and their uses. Includes illustrations and a chart on bur sizes.

61-1033 (Softcover – 47 pages)



18. Jewelry Making Techniques Book

by **Elizabeth Olver**

A comprehensive guide to jewelry making. Full color photographs which explain each of the techniques. Contains vital information on metal forming, casting and finishing.

61-1043 (Softbound 116 pages)



14. At the Bench:

A Guide to Working with Gold & Silver

by **Gregg Todd and Greg Gilman**

An illustrated resource book on how to fabricate gold and silver jewelry. Step-by-step instructions with over 200 photographs and illustrations. A very useful book to upgrade your skill level.

61-1034 (Softbound 116 pages)



19. Basic Jewelry

Making Techniques

by **Jinks Mcgarth**

Learn the basics as well as the advanced techniques of jewelry making. Contains suggestions for planning a workshop. Includes step-by-step lessons to develop your skills.

61-1044 (Softbound 112 pages)

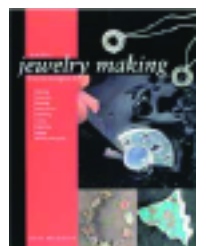

15. Jewelry Making:

Tips and Tricks of the Trade

by **Stephen O'keefe**

A beginners manual with ideas for the professional as well. More than 30 projects with photographic illustrations and step-by-step instructions. Teaches the basics of jewelry making and how to avoid common problems.

61-1035 (Softbound 128 pages)



20. Jewelry Wax Modeling

by **Adolfo Mattiello**

Learn how to effectively use carving wax to express your ideas and create harmonious designs. Jewelry modeling techniques are presented with progressive step-by-step instructions and drawings of each model. Contains practical information on tools and stone setting, as well as creating your own templates. Provides answers to frequently asked questions.

61-1051 (Hardcover – 161 pages)

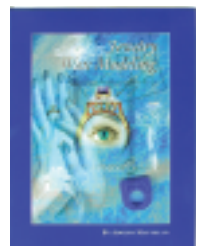



21. Basic Wax Modeling

by **Hiroshi Tsuyuki**

This book illustrates how practical wax modeling is for designing jewelry. Presents 11 basic projects designed to teach the use of tools and types of waxes in the design and creation of wax models. Step-by-step photos, descriptions, sketches and notes demonstrate the processes of each project. Offers a number of sketches suggesting design possibilities.

61-1052 (Hardcover – 164 pages)



22. Practical Wax Modeling Advanced Techniques for Wax Modelers

by **Hiroshi Tsuyuki and Yoko Oba**

The companion text to "Basic Wax Modeling" with detailed instructions and photos of each technique. Covers soft and hard wax modeling techniques, combinations of waxes, mitsuro and its uses, a variety of textures and methods of finishing castings. Helpful for experienced wax workers and as an addition to "Basic Wax Modeling."

61-1053 (Hardcover – 154 pages)

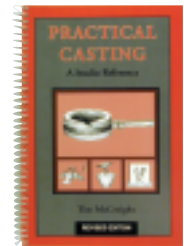

23. Practical Casting: A Studio Reference

by **Tim McCreight**

A handy reference for jewelers, metalsmiths and sculptors. Covers many different techniques including model-making, spruing, investing, as well as vacuum, centrifugal and sand casting.

61-1061 (Spiral bound – 152 pages)



24. Centrifugal or Lost Wax Jewelry Casting (Revised Edition)

by **Murray Bovin; Revised by Peter M. Bovin**

This how-to book, detailing the elements of centrifugal casting (lost wax method), is a must for beginners and professionals. Thorough explanations on waxes, model making, investing, burnout and casting. This revised edition covers the latest techniques and equipment. Useful information on white metal casting and gold refining. Includes photos of work in progress.

61-1062 (Spiral bound – 143 pages)

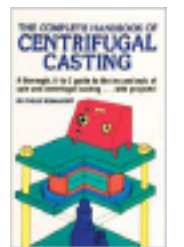

25. The Complete Handbook of Centrifugal Casting

by **Philip Romanoff**

One of the best books on casting. In depth details on mold making, spin and centrifugal casting. Teaches you to make prototypes, as well as production castings. Illustrated with detailed drawings.

61-1063 (Softcover – 256 pages)



26. The Complete Metalsmith

by **Tim McCreight**

A handy bench reference that clearly explains shaping, forging, raising, mechanisms, casting and reticulation. This easy-to-use book describes everything from the use of tools to metals and their properties.

61-1071 (Spiralbound – 150 pages)



27. Silversmithing and Art Metal For Schools, Tradesmen, Craftsmen (Revised Edition)

by **Murray Bovin; Revised by Peter M. Bovin**

An excellent project-oriented book for silversmiths. Contains the latest metal techniques including forming, constructing and decorating. Easy-to-follow instructions with over 300 illustrations.

61-1072 (Softcover – 176 pages)

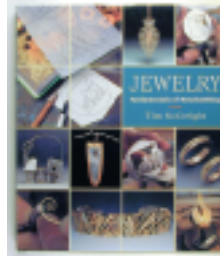

28. Jewelry: Fundamentals of Metalsmithing

by **Tim McCreight**

Clear and insightful instruction on jewelry making methods for the beginner or intermediate metalsmith. Features various techniques including fabricating, surface treatments, joining, finishing, stone setting, chain making, mechanisms and casting. Color photos of finished pieces are used to demonstrate each technique.

61-1073 (Hardcover – 143 pages)



29. Silversmithing

by **Rupert Finegold & William Seitz**

An excellent instructional manual that enables you to translate your jewelry designs into metal by raising, sinking, forging, stretching, fabricating, or casting. Contains more than 700 photos and drawings.

61-1074 (Hardcover – 460 pages)



30. Mokume Gane A Comprehensive Study

by **Steve Midgett**

Provides solid information about the process of mokume gane (wood grain metal). Each technique is thoroughly covered with tips from the finest makers in the world. Includes step-by-step instructions, information on metal compatibility and firing temperatures. Over 150 color photos including 25 pages of mokume gane art by accomplished masters.

61-1075 (Hardcover – 160 pages)



31. Form Emphasis for Metalsmiths

by **Heikki Seppa**

An advanced manual on the techniques of metalsmithing. Teaches you how to craft metal in terms of pure form. Discusses all the aspects of metal raising, sinking, stretching and fabricating. Includes an illustrated glossary.

61-1076 (Softbound – 146 pages)



36. The Art of Engraving

by **James B. Meek**

A complete authoritative introduction to the art of gun engraving. Contains step-by-step instructions, technical information, designs and layouts to complete each project. Over 1,400 photos, drawings and designs.

61-1115 (Hardcover – 196 pages)



32. The International

Cyclopedia of Monograms

by **Leonard G. Lee**

This volume comprises altogether the most extensive collection of Monograms, Alphabets, Initials, Types, Crests, Coat-of-Arms, emblems, badges, shields and other decorations. Every engraver, jeweler and artist should invest in this book especially at this exceptionally reasonable price.

61-1111 (Hardcover – 368 pages)



37. Plating Made Easy

by **Hoover and Strong**

A beginners guide on plating desirable colors in gold, silver and rhodium. Explains and describes procedures on electrostripping, electroplating and troubleshooting.

61-1211 (Spiral bound – 23 pages)



33. Drawing & Understanding

Scroll Designs -#022-199

by **Ron Smith**

Written by a professional engraver, this book helps you design outstanding and pleasing scrolls. Ron Smith illustrates what separates impressive scroll designs from amateur ones. This book is written for Artists, Engravers and Collectors of engraved work.

61-1112 (Spiral bound - 47 pages)



38. The Jeweler's Directory of

Decorative Finishes

by **Jinks Mcgarth**

This beautiful book is a treatise on decorative finishes from enamelling and engraving to inlay and granulation. Includes helpful tips and a glossary of terms. Illustrated with color photographs.

61-1212 (Softbound 128 pages)



34. Basic Engraving - #022-192

by **Benno Heune**

He began engraving in 1944 and has used many techniques and tools. He loves teaching and has dedicated his recent years to it. His book is written "...for those who want to learn The Art of Engraving." It presents the basics in an easy-to-understand format. Every engraver will gain important knowledge from this useful book.

61-1113 (Spiral bound-45 pages)



39. The Art of Fine Enameling

by **Karen L. Cohen**

Read the fundamentals of enamelling. More than 20 step-by-step projects teach you how to select and prepare your enamels. Get the advice tips and tricks to produce excellent work.

61-1213 (Softcover – 160pages)



35. The Jewelry Engravers Manual #022-202

by **R. Allen Hardy and John J. Bowman**

This book concentrates on jewelry engraving, with special emphasis on lettering, monogramming, and ring engraving. Use of tools and proper work techniques are clearly described so you can learn to hand engrave jewelry yourself.

61-1114 (Softbound – 143 pages)

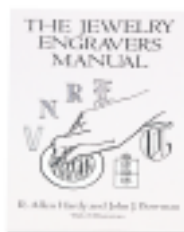

40. Practical Jewellery Repair

by **James Hickling**

An excellent reference book about the methods and techniques of the professional jewelry repairer and restorer. Demonstrates a wide range of repair work using modest tools; the various processes and materials required; and stock holding of precious metals, solders and gemstones. Covers and illustrates basic techniques of soldering, casting, wire-drawing, polishing, sawing and filing.

61-1221 (Hardcover – 193 pages)





41. Ring Repair

by **Alan Revere**

Documents the repair, alteration and restoration of rings in gold, silver and platinum. This book is full of trade secrets and tips and is indispensable to anyone who works with rings. A combination of text and photography presents every step of each project in a clear, concise manner. Includes 140 color photos and 90 sketches.

61-1222 (Softcover – 128 pages)

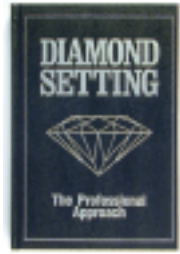

42. Diamond Setting:

The Professional Approach

by **Robert R. Wooding**

A complete course in stone-setting, basic enough for an apprentice, yet in-depth enough to benefit the experienced setter. Explores various setting techniques and the preparation, use and care of tools. Detailed explanations of pin-point and prong-setting (round and fancy-cut diamonds), bezel setting, channel setting and bead setting.

61-1231 (Hardcover – 178 pages)

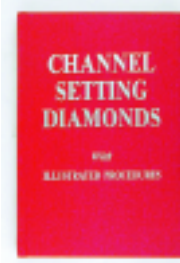

43. Channel Setting Diamonds with Illustrated Procedures

by **Robert R. Wooding**

Step-by-step channel setting techniques from basic to advanced. Common channel setting problems with workable solutions. Over 124 illustrations.

61-1232 (Hardcover – 136 pages)



44. The Diamond Setting Manual Procedures & Techniques

by **Robert R. Wooding**

The text is divided into 17 chapters of illustrated step-by-step instructional procedures that describe how to set a diamond into a particular type of mounting or setting. The manual will provide an opportunity for diamond setters to progress to higher echelons of diamond setting.

61-1233 (Spiral bound – 223 pages)



45. Bead Setting Diamonds Pavé Applications

by **Robert R. Wooding**

A detailed instructional book on bead and pavé setting for the apprentice or advanced diamond setter. Specific procedures, from design and layout to bright cutting, plus advanced work in setting different shapes and clusters are illustrated. Included is a discussion of diamond-setting tools and their care.

61-1234 (Hardcover – 192 pages)



46. Gemstones of the World

by **Walter Schumann**

A comprehensive reference guide for gemstones containing color photos of more than 1,400 specimens. Includes technical data on gemstone properties, formation and structure of gems and cutting. Recommended for beginners and experts.

61-1235 (Hardcover – 272 pages)

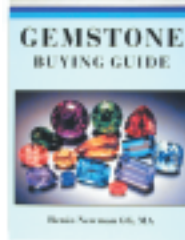

47. Gemstone Buying Guide

by **Renée Newman**

Fascinating, easy-to-read guide for choosing and buying colored gems. Practical pointers for judging gems by their color, transparency, flaws and brilliance. Includes topics on gem treatments, cleaning and care, as well as price comparisons, quality evaluations and fake stones.

A valuable resource for consumers and professionals.

61-1236 (Softcover – 148 pages)

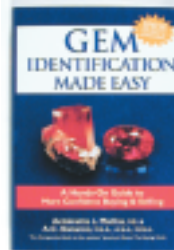

48. Gem Identification Made Easy

by **Antoinette L. Matlins & A. C. Bonanno**

Easy-to-read book that explains how to use pocket, portable and laboratory instruments to identify diamonds and colored gems. Learn how to recognize real gems from imitations. Provides the latest information on treatments to improve a gem's appearance.

61-1237 (Hardcover – 270 pages)



49. The Basics of Bead Stringing

by **Debbie Kanan**

A complete illustrated approach for beginners and advanced designers. Specific procedures, to begin designing and producing their own jewelry.

61-1251 (Soft cover – 62 pages)



50. Advanced Beadwork

by **Ruth F. Poris**

An indispensable book for anyone interested in beadwork. A classic teaching manual. Explores all of the major beading techniques. Provides information on metalworking, findings, tools and supplies that are needed for stringing beads. Over 300 illustrations and photos.

61-1252 (Softcover – 146 pages)



51. Creative Bead Jewelry

by Carol Taylor

Anyone can learn to make incredible earrings, necklaces, bracelets, pins, barrettes and other accessories. Bead-by-bead instructions with color photos for more than 55 projects. Make your own jewelry using a wide range of bead styles. Tips on stringing, wiring, looming and making your own beads using polymer clay, fabric, paper or bamboo.



61-1253 (Softcover – 144 pages)

52. Step-By-Step Bead Stringing

by Ruth F. Poris

This well-illustrated manual describes basic tools, supplies and findings for stringing beads. Provides detailed beading techniques for single and multi-strand stringing and knotting, using a variety of bead cords. Required reading for bead-ers.



61-1254 (Softcover – 48 pages)

53. Beadifferent: Make Wire Beads

by Lisa Van Henrik

The first book to address beads made exclusively with wire. Create unique wire beads using a wide variety of metal wires. Instructions on making over 40 unique wire beads. Make simple to sophisticated beads and jewelry, in minutes, with breakthrough techniques and tips to guide you through the process.



61-1255 (Spiral bound – 64 pages)

54. Quick & Easy Beaded Jewelry

by Elizabeth Gourley & Ellen Talbott

Create color matching beaded jewelry. Learn the techniques of stranding, peyote, stitch and netting. Full color illustrations with detailed line art guidance on more than 20 projects.



61-1256 (Softbound 128 pages)

55. Great Wire Jewelry

Projects and Techniques

by Irene F. Peterson

Create beautiful jewelry using only wire, jumpings and a few basic tools. More than 70 fully illustrated projects with step-by-step diagrams. Each project has a skill level rating.



61-1257 (Hardcover – 60 pages)

56. Elegant Wirecraft Jewelry - Vol I, II, III and IV Set of 4

by Esther Lee

61-1261: Vol I Learn to make chain styles and more.

(Spiral bound - 44 pages)

61-1262: Vol II Learn to make glass beads and more.

(Spiral bound - 50 pages)

61-1263: Vol III Learn to make complex chain styles.

(Spiral bound - 52 pages)

61-1264: Vol IV Learn to make new patterns and new styles using old patterns.

(Spiral bound - 40 pages)

61-1265 Set of 4 Vol. I-IV



57. Classical Loop-in-Loop

Chains & Their Derivatives

by Jean Reist Stark & Josephine Reist Smith

Clearly presented procedures for making a variety of chains based on classic loop-in-loop techniques. Details 34 projects with black & white photos and drawings to guide you through each step. Tools and equipment for each project are specified and appropriate clasps for each chain type are suggested.

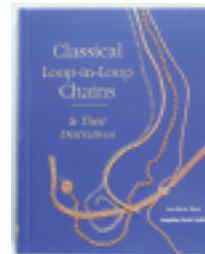

61-1259 (Hardcover–190 pages)

58. Professional Goldsmithing

Jewelry Techniques by Alan Revere

An indispensable reference guide to the art of handcrafting fine jewelry for both beginners and professionals. Combines over 400 color photos and 140 illustrations with charts, tables and step-by-step projects. Learn how to make rings, bracelets, chains, clasps, earrings and necklaces.



61-1081 (Hardcover – 226 pages)

59. Jewelry Making Manual

by Sylvia Wicks

An excellent introduction to metalsmithing covering a wide range of techniques. Covers hand-fabricating, enameling, engraving, repoussé and chasing, plus a section on jewelry illustration. 300 illustrations, more than 150 in full color, makes complex techniques understandable.

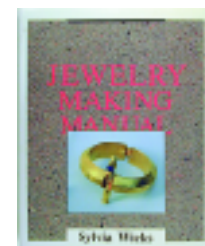

61-1121 (Hardcover – 176 pages)

60. Jewelry Technology

by Diego Pinton

Study the techniques, methods, tools and equipment used in jewelry production. Defines metals, alloys and chemicals commonly used by goldsmiths. Melting, rolling, drawing and stamping are among some of the fundamental processes discussed. Translated from Italian; textbook-like in structure.



61-1128 (Softcover – 407 pages)

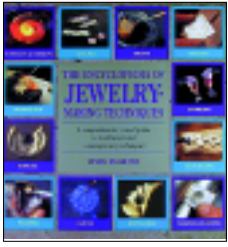

61. The Encyclopedia of Jewelry Making Techniques

by Jinks Mcgarth

From simple techniques for bending or knitting wire to elaborate creations of gold and diamonds, this book describes all the essential skills needed to create your own jewelry. An A to Z visual directory details more than 40 crafting techniques. Each method is explained and illustrated through elaborate step-by-step photos and text.

61-1122 (Hardcover – 176 pages)



66. Wolf's Precision Wax Carvers book

by Kate Wolf

Discover the techniques of wax carving using the "wicked sharp" tools by Kate Wolf. Read about the diverse methods of how to modify and finish a carving. Includes projects on carving and bezel setting.

61-1132 (Softcover – 24 pages)



62. The Theory & Practice of Goldsmithing

by Dr. Erhard Brepohl

The book (translated from the popular German edition) is an important resource for jewelers, sculptors and others involved in small scale metalwork. Contains chapters on metal, studio chemistry, handworking skills, machine tools, settings, findings and repair work.

61-1123 (Hardcover – 536 pages)



67. Modeling in Wax For Jewelry and Sculpture (Second Edition)

by Lawrence Kallenberg

This recently updated book on waxwork is extensive and complete. It covers the whole range of topics for sculpting in wax and casting in metal. Detailed drawings provide a helpful reference for the beginner and the advanced modelmaker.

61-1127 (Softcover – 252 pages)

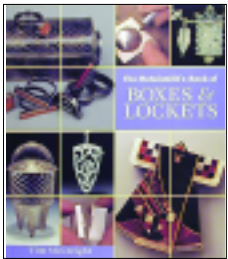

63. The Metalsmith's Book of Boxes and Lockets

by Tim McCreight

Introduces a variety of metalworking techniques for box construction, hinges and closing devices. Detailed demonstration photos and expert instructions prepare the metalworker for the challenge of designing his own boxes. Displays gorgeous metal containers from top artists in the field. Perfect for the novice or experienced metalsmith.

61-1124 (Hardcover – 144 pages)

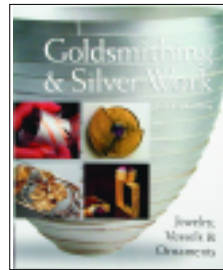

68. Goldsmithing & Silver Work

by Carles Codina

Goldsmithing and silver work are the time-honored techniques for making jewelry, as well as other exquisite decorative items. Experience the pleasure of crafting with these precious metals, and of using your creativity and skills to produce objects of great beauty. Hundreds of color photographs illustrate the procedures in rich detail, and display a breathtaking assortment of pieces by talented artist, Munsteiner, considered the best gem cutter in the world—makes this sourcebook invaluable! all in color.

61-1129 (Hardcover – 160 pages)



64. Metal Corrugation

by Patricia McAleer

A required reference for texture lovers, enamellists, glass fusing artists and those working with precious metal clay. A completely new and quick way to create intense surface textures using sheet, strip and wire. Utilizing a variety of tools and techniques. Construction methods are discussed along with instructions on how to create surface textures on die and fold formed elements. Over 280 full color photographs.

61-1125 (Softcover – 148 pages)



69. 500 Earrings: New Directions in Contemporary Jewelry

by Lark

Poring through the beautiful images in this exquisite gallery of earrings is like stepping inside a jewelry store filled with remarkable pieces from the finest contemporary jewelers. Juried by award-winning designer Alan Revere, the earrings range from the classic to the avant-garde, and come from an international array of artists, including Cynthia Eid, Rachele Thiewes, and Jeff and Susan Wise. everyone who appreciates fine craftsmanship will enjoy this collection.

61-1130 (Softcover – 405 pages)



65. Wax and Casting

A Notebook of Jewelry Design and Technique

by Roger Armstrong

Explores jewelry design and techniques in an informal easy-to-follow notebook format. Contains instructions with black & white illustrations covering a wide variety of wax and casting techniques.

61-1126 (Hardcover – 186 pages)

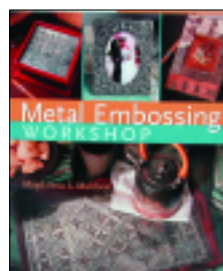

70. Metal Embossing Workshop

by Magdalena S. Muldoon ; Mickey Basket

It's simple to create intricate designs on metal—and impart luster, radiance, and dimension—with the centuries-old art of embossing. This in-depth workshop, packed with close-up images and instructional photos, explains it all: tracing and transferring patterns, cutting designs from the metal and attaching them to a surface, filling in, adding color and patina, finishing and varnishing, and texturizing.

61-1131 (Hardcover – 125 pages)



BENCH ACCESSORIES

- Adjustable Scraper - France 43
- Bench Horn Anvil & Block 40
- BenchMate- GRS 48
- Block Shelves- GRS 49
- Bracelet and Ring Sizers- Wooden 50
- Bracelet Holder 47
- Bracelet Mandrels 50
- Burnishers- Steel, Agate 42, 43
- Combination Bench Pin with Anvil 40
- Contour Vise Jaws - GRS 49
- Dapping Block- Rubber 42
- Double Ended Tracer 49
- GRS Microblock - Ball Vise 43
- Hand Drill - German 46
- Holder with Chuck 41, 49
- Inside Ring Holder 45
- Jump Ringer System 41
- Kirkland Ring Clamps- USA 49
- Knifemaker's Contour Vise - GRS 50
- Magnetic Tool Holder 43
- Margin Rollers 46
- Millgrain Wheels & Tool Sets 47
- Miter Cutter Jig- France 49
- Multi-Purpose Vise- GRS 42
- Outside Ring Holder 47
- Panavise 47

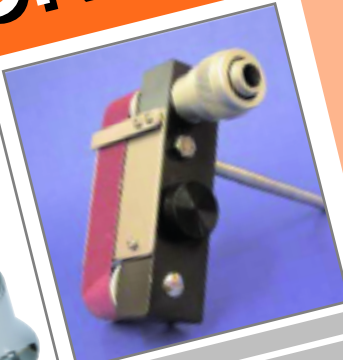

- Pearl Drilling Vise 47
- Peg Clamp Holder 42
- Portable Worklight -LED 50
- Quick-Grip Bar Clamp 42
- Ring Clamps & Gripper 41
- Ring Setters Clamp 46
- Screwplates with Taps 44
- Setter's Ring Clamp - USA 41
- Spiral Hand Drill 43
- Steel Bench Block 40
- Swiss Victorinox Knife 47
- Third Hand -Multi-Purpose 45
- Tool Storage & Plier Organizers 50
- Tools for Filing -Hinges 42

- Tube Cutter 47
- Utility Combination Anvils & Stakes 40
- V-Slot Bench Pin with Clamp 42
- Watchmaker's Tap and Die Set - Wiru 44
- Wolf's Belt Sander 44
- Wood Bench Pins 41
- Wood Handle Scrapers 43



The Jeweler's Bench Reference

by **Harold O'Connor**
 A handy pocket-size reference guide that explains all types of jewelry making techniques. Vital information on fabricating, soldering, stone-setting, plating and casting.
61-1032 (Spiral bound - 68 pages)





1. Utility Combination Anvils

Easy to use. Quick change over from steel to nylon face for all bench tasks. Simply press out from base and reverse. Hard neoprene non-slip base provides secure positioning and absorbs light to heavy hammer action.

ITEM #	DESCRIPTION	SIZE	WT.
23-1011	UTILITY ANVIL	2"	1¼ LB
23-1012	UTILITY ANVIL	3¼"	2¼ LB



2. Utility Bench Stakes

Table top combination stake with four different shaped ends. Made of hardened and tempered steel. Choose the end that conforms to the shape of the item to be formed.

ITEM #	DESCRIPTION	SIZE	WT.
23-1015	COMBINATION STAKE	Ø 4¼" X 4¾"H	3 LB

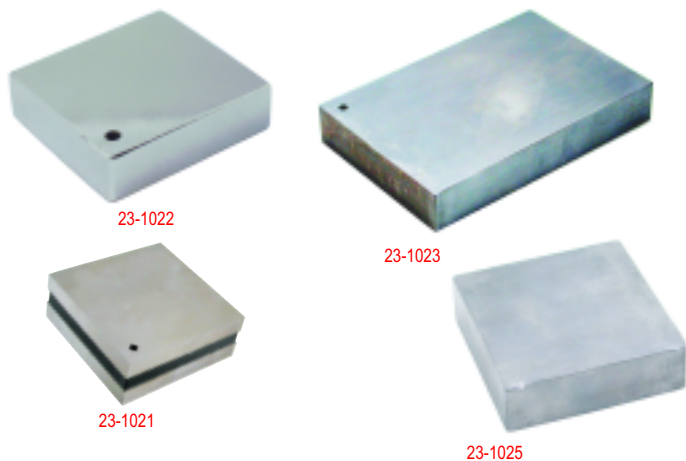

3. Bench Block

Flat steel base for marking and layout of designs. Case hardened, ground and polished. Includes a hole for riveting.

ITEM #	DESCRIPTION	WT.
23-1021	STEEL- 2¼" X 2¼" X 1"	1¼ LB
23-1022	STEEL- 4" X 4" X 1"	3¼ LB
23-1023	STEEL- 6" X 4" X 1"	5½ LB
23-1025	LEAD- 3¼" X 3¼" X 1"	4 LB

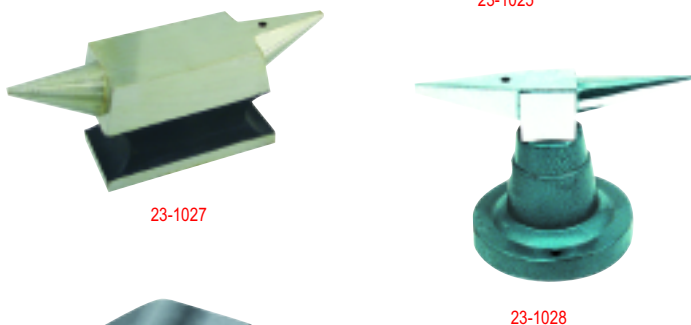

4. Bench Horn Anvil

One piece solid steel. Includes both round and flat horns, with a hole on top for riveting. Useful for flattening, shaping and forming.

ITEM #	DIMENSIONS	WT.
23-1027	4½" L X 1⅝" Ht	1 LB
23-1028	4⅝" L X 2⅝" Ht	1¼ LB

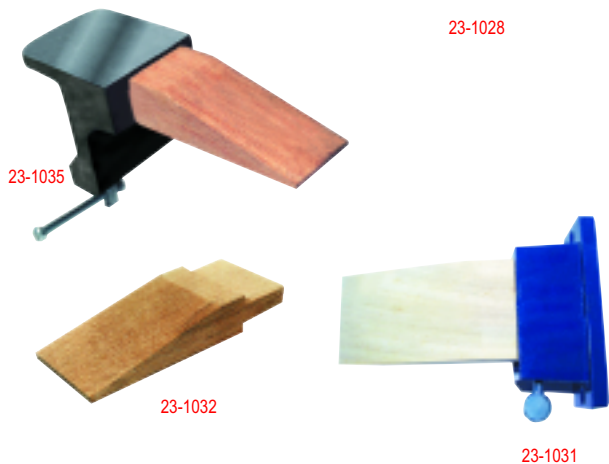

5. Combination Bench Pin with Anvil

Easily clamps to the workbench. Has a flat polished anvil for layout work, together with a replaceable hardwood bench pin for various other jobs.

ITEM #	DESCRIPTION	DIMENSIONS
23-1031	BENCH PIN W/METAL HOLDER	3¾" X 2¼"
23-1032	BENCH PIN - SMALL FOR 23-1031	5¼" X 2¼"
23-1035	BENCH PIN WITH ANVIL	4¼" X 1¾"
23-1036	REPLACEMENT PIN FOR 23-1035	4" X 1¾"



6. Wood Bench Pins

Assorted sizes made from quality, seasoned hardwood. Smooth finished all over. The tongue fits all standard metal holders.

ITEM #	DESCRIPTION	DIMENSIONS
23-1032	BENCH PIN - SMALL	5 1/4" X 2 1/4"
23-1033	BENCH PIN - MEDIUM	6 1/4" X 2 1/2"
23-1034	BENCH PIN - LARGE	7" X 2 3/4"
23-1037	BENCH PIN - RIGHT	6" X 2 3/4"
23-1038	BENCH PIN - LEFT	6" X 2 3/4"

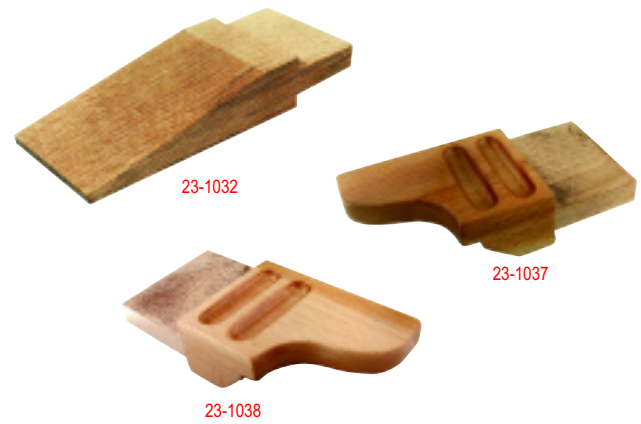

7. Kirkland® Ring Clamps- USA

Precision aluminum construction with quick acting thumb screw grip. This hand fixture is very practical for working on rings. Indispensable for stone setting and polishing.

ITEM #	DESCRIPTION	LENGTH
23-1041	COMBINATION CLAMP	5 3/8"
23-1042	RING CLAMP-EXTERNAL	6"



8. Ring Clamps

Seasoned hardwood with leather lined jaws, adjustable to fit most rings. This useful tool ensures a positive grip on rings during filing and polishing.

ITEM #	DESCRIPTION
23-1045	RING CLAMP- WOOD RUSSIAN TYPE - 6"
23-1046	RING CLAMP - HARDWOOD DELUXE - 6"
23-1047	RING CLAMP - PLASTIC RING CLAMP- 6"
23-1048	RING CLAMP - PARALLEL RING CLAMP- 6"

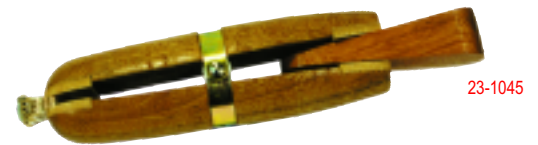

9. Inside Ring Holder

Holds large and small rings from the inside, with a strong grip. Enables free working on the outside of the rings without leaving any scratch marks.

ITEM #	DESCRIPTION
23-1051	RING HOLDER WITH WING NUT - 6"



10. Setter's Ring Clamp- USA

This ring clamp has an extended lip of a unique design that provides extra support on a workbench. Ideal for polishing and other detail work.

ITEM #	DESCRIPTION
23-1052	PLASTIC RING CLAMP - DELUXE 6"



11. Ring Gripper

Thumb screw clamp gives a firm grip on large or small rings. May be used while buffing and polishing the outside of the rings.

ITEM #	DESCRIPTION
23-1053	RING GRIPPER - 7 1/4"



BENCH ACCESSORIES



12. Outside Ring Holder

Holds the outside of large and small rings in either of the two grooves. Enables easy and free working on the inside of rings.



ITEM #	DESCRIPTION	LENGTH
23-1055	OUTSIDE RING HOLDER	8"

14. Tools for Filing -France

A high quality steel holder with an adjustable grip for various sizes of hinges. Its unique design eliminates wobble while filing.



ITEM #	DESCRIPTION	LENGTH
23-1058	HOLDER FOR HINGE PINS	7½"

16. Double Ended Tracer

An economical steel scribe with precise sharpened points at both ends. Highly accurate for marking layout work when designing.



ITEM #	DESCRIPTION	LENGTH
23-1083	DOUBLE END TRACER	4½"



23-1071

13. V-Slot Bench Pin with Clamp- German

A portable bench pin for a quick set up. It clamps to almost all workbenches. Ideal for sawing, filing and finishing.



ITEM #	DESCRIPTION	SIZE
23-1057	V-SLOT BENCH PIN	7¼" X 2¼"

15. Peg Clamp Holder

Hand held holder with moveable pins to hold odd shaped parts. Remove handle to fit in a vise. Useful when engraving and setting.



ITEM #	DESCRIPTION	LENGTH
23-1059	PEG CLAMP	5¼"

17. Quick-Grip Bar Clamp- German

A versatile clamp that changes from a clamp to a spreader. Made from reinforced resin. Non-marring pads firmly grip the work. Quick release trigger for fast positioning.



ITEM #	DESCRIPTION	LENGTH
23-1062	QUICK- GRIP CLAMP	6"

18. Burnishers

Micro-grained, super hard tungsten carbide will smooth and finish all metals including platinum. Silver or gold will not adhere to this burnisher. Excellent for closing and smoothing. Also available in steel.

ITEM #	DESCRIPTION	L
23-1071	TUNGSTEN CARBIDE 5/32" Ø	8"
23-1072	STEEL 1/8" Ø BRASS HANDLE LONG	8"
23-1073	STEEL 1/8" Ø BRASS HANDLE SHORT	5½"
23-1074	STEEL 5/32" Ø BRASS HANDLE	8"
23-1075	STEEL 3/16" Ø BRASS HANDLE LONG	8"
23-1076	STEEL 1/4" Ø BRASS HANDLE LONG	8"



19. Burnishers-Steel

Polished, straight or curved steel blade, with comfortable hardwood handle. These tools may be used to open or close bezel settings in hard to reach places. Overall length 6".

ITEM #	DESCRIPTION	LENGTH
23-1111	STRAIGHT- 1 $\frac{3}{4}$ " BLADE	6"
23-1112	CURVED - 2" BLADE	6"

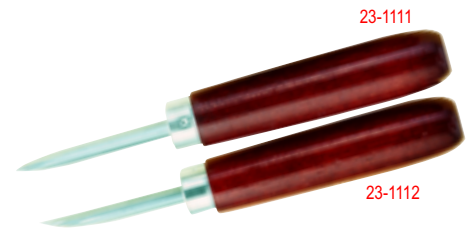

23-1111

23-1112

20. Burnishers - Agate

Made of natural stone, straight or knife edged, the super polished surface of the burnishers smoothes all marks or other imperfections on jewelry.

ITEM #	DESCRIPTION	LENGTH
23-1115	W/HANDLE -STRAIGHT	8 $\frac{1}{2}$ "
23-1116	W/HANDLE -KNIFE EDGE	8"

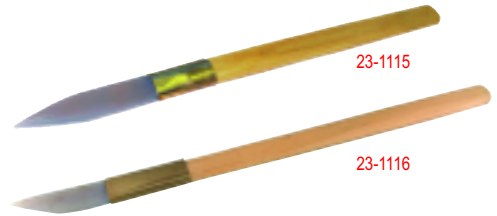

23-1115

23-1116

21. Wood Handle Scrapers

Economical steel scrapers in chrome alloy steel. A three square blade in solid or hollow shape mounted in hardwood handle. Overall length 7".

ITEM #	DESCRIPTION	BLADE LG.
23-1117	SCRAPER -HOLLOW	2 $\frac{1}{2}$ "
23-1118	SCRAPER -SOLID	2 $\frac{1}{2}$ "



23-1117

23-1118

22. Adjustable Scraper

This adjustable scraper has a holder and a lock screw to permit the setting of the hollow tool bit for depth of cut. Useful for fine detail and scraping of excess solder.

ITEM #	DESCRIPTION
23-1121	SCRAPER 3 $\frac{1}{8}$ " LONG - FRANCE
23-1122*	SCRAPER 3 $\frac{1}{8}$ " LONG - VALUE

*Picture not shown



23-1121

23. Margin Rollers

Individually sized burnishing tool that effectively removes porosity, pits or scratch marks on the inside of rings and bracelets.

ITEM #	DIAMETER	SHANK
23-1131	12 MM	$\frac{3}{32}$ "
23-1132	10 MM	$\frac{3}{32}$ "
23-1133	8 MM	$\frac{3}{32}$ "

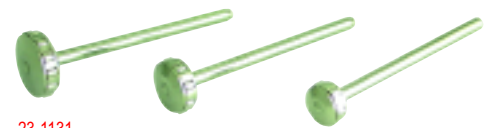

23-1131

23-1132

23-1133

24. Hand Drill - German

Smooth operating drill with adjustable chuck capacity $\frac{1}{32}$ "- $\frac{1}{4}$ ". Sturdy tool for general purpose use.

ITEM #	DESCRIPTION
23-1141	HAND DRILL - 9 $\frac{1}{2}$ " LONG



23-1141

25. Spiral Hand Drill

A light spiral driven drill for micro drilling of layouts and marking fragile objects. Chuck accepts drill #65-#80.

ITEM #	DESCRIPTION	LENGTH
23-1142	SPIRAL HAND DRILL	4 $\frac{1}{2}$ "



23-1142



BELT SANDER



23-1151



23-1152

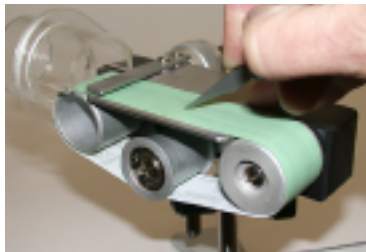

3M Sanding Belts



26. Wolf's Belt Sander

This compact and convenient belt sander is ideal for sprue grinding, model making and bench work. It is powered by a flex shaft and easily attaches with the quick change collar. Clamps to the workbench and positions to any angle. Easy belt changing and tensioning. Uses 1" x 10 1/2" belts. Optional GRS BenchMate attachment fits into pivoting BenchMate collar. Unit includes five belts of assorted grits.

Set Includes: Belt sander with quick connect (without flexshaft), table clamp with universal attachment five assorted sanding belts (80, 120, 150, 240, 320) Instruction manual.



Adapter for GRS BenchMate

The optional GRS adapter 23-1152 (not included) fits into the GRS pivoting BenchMate collar (not included). This allows for the easiest, infinite angle positioning and rotation to work in between the rollers.

ITEM #	DESCRIPTION
23-1151	BELT SANDER
23-1152	ADAPTER FOR GRS BENCHMATE

3M® Sanding Belts

3M® Sanding belts: "XODust", Trizact™, Imperial™ Microfinishing film and Diamond in a wide variety of grits are available. See page #7

BELT SANDING APPLICATIONS
Graver and chisel sharpening, metal finishing (gold, silver, brass, copper, platinum, stainless steel). Good for finishing wood, plastics, enamel and fiberglass.

27. Screwplates with Taps

Three different ranges to form internal or external fine pitch threads for nuts or screws. May also be used to rectify and repair damaged threads.

ITEM #	DESCRIPTION
23-1161	0.60- 2.00MM - SWISS
23-1162	0.70- 2.00MM - GERMAN
23-1163	0.85-1.50MM - DELUXE

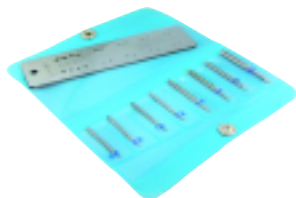

23-1161



23-1162



23-1163



28. Watchmakers Tap and Die Set

Precision tap and die sets for watch, clock and jewelry repair.

Wiru 1: 8 sets of 3 taps: M1, M1.2, M1.4, M1.7, M2, M2.3, M2.6, M3
8 screw dies with metric threads, die handle, adjustable tap handle. Supplied in a wooden case.

ITEM #	DESCRIPTION
23-1166	TAP AND DIE SET - WIRU 1



29. Third Hand -Multi Purpose

A very useful third hand for general bench, soldering and repair work. The arm is flexible and can be locked in any position. Optional accessories are available. These may be added on when needed: a tungsten tip, torch holder, UV filter or magnifier. All parts are interchangeable and may be easily fitted.

ITEM #	DESCRIPTION
50-1021	THIRD HAND BASE ARM ONLY
Accessories for 50-1021	
50-1022	TUNGSTEN TIP
50-1023	TORCH HOLDER
50-1024	UV FILTER
50-1025	MAGNIFIER

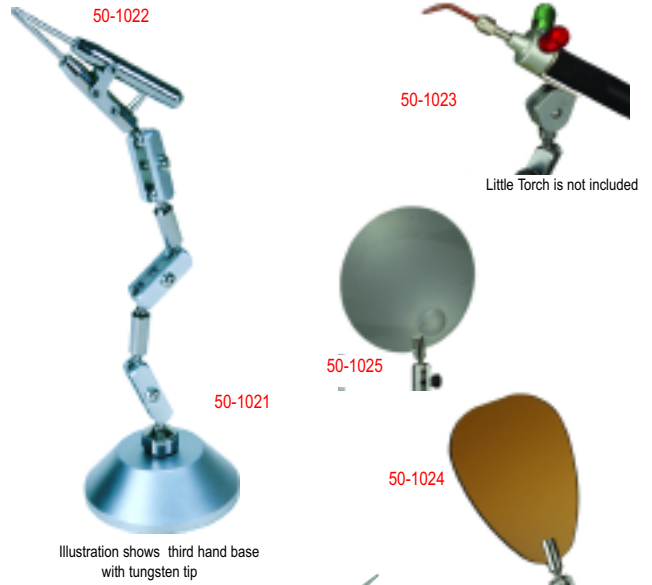

Third Hand -Round Base

Heavy base with double joint positioning, makes for hands free working while soldering. Includes straight cross locking tweezers to hold the component.

ITEM #	DESCRIPTION
50-1031	THIRD HAND BASE WITH TWEEZER
50-1032	THIRD HAND BASE ONLY
56-1253	CROSS LOCK TWEEZER



30. Jump Ringer System

An easy way to make perfectly uniform jump rings. Bench mounted hand winder converts wire stock into a coil. Coils may be made in different shapes by using special mandrels. Coils are clamped in a holder and cut by using a rotary saw. Use a Foredom #30 handpiece (not provided) for the cutting attachment. Suitable for cutting gold, silver, brass, copper and aluminum wire.



23-1212: Jump Ringer Complete:
Winding attachment with three round mandrels and chuck key, blade with arbor and guide, holder to cut rings and instructions (as shown in the illustration).

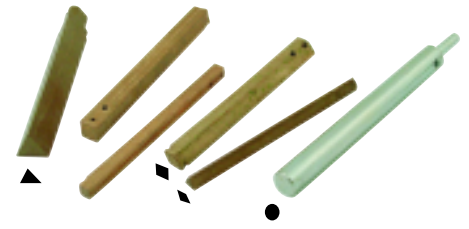

Note: Triangle, square, diamond and oval mandrels need to be ordered with multi shaped coil holder.

ITEM #	DESCRIPTION
23-1211	MULTISHAPE JUMP RINGER COMPLETE
23-1212	JUMP RINGER COMPLETE
23-1213	WINDING ATTACHMENT W/3 MANDRELS
23-1214	REPLACEMENT BLADE ONLY
23-1215	CUTTING ATTACHMENT-RND J/RINGS
23-1217	JUMP RINGER BLADE ARBOR ONLY

Optional Accessories:

ITEM #	DESCRIPTION
23-1216	MULTI SHAPED COIL HOLDER
23-1221	ROUND MANDREL SET - 16 PCS
23-1222	TRIANGLE MANDREL SET - 7 PCS
23-1223	SQUARE MANDREL SET - 7 PCS
23-1224	DIAMOND MANDREL SET - 7 PCS
23-1225	OVAL MANDREL SET - 7 PCS



- 1 9
- 2 10
- 3 11
- 4 12
- 5 13
- 6 14
- 7 15
- 8 15

31. Millgrain Wheels-France

Precision concave, equally shaped cavities may be formed with a hardened wheel. Create decorative settings and edge beading on jewelry. Use tools with a Millgrain wheel holder.

ITEM #	SIZE	ITEM #	SIZE
23-1231	#1	23-1239	#9
23-1232	#2	23-1240	#10
23-1233	#3	23-1241	#11
23-1234	#4	23-1242	#12
23-1235	#5	23-1243	#13
23-1236	#6	23-1344	#14
23-1237	#7	23-1245	#15
23-1238	#8		

Note : Patterns shown are not the actual size of the wheel structure.

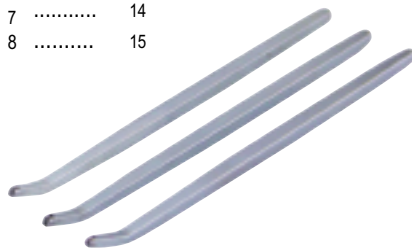

23-1251



23-1252



23-1261



23-1262



23-1263



23-1264

32. Millgrain Tool Set

High quality millgrain tools for forming decorative edges on settings and bezels. Complete set organized in a polished wooden box.

ITEM #	DESCRIPTION
23-1251	SET OF 6 (#10-15)
23-1252	SET OF 12 (#1-12)
23-1255	BOX ONLY

33. Holder with Chuck

A hand tool having a hardwood palm grip with a metal screw chuck to secure the shank of millgrain wheels.

ITEM #	DESCRIPTION
23-1261	ROUND
23-1262	MUSHROOM
23-1263	PEAR
23-1264	TAPERED SPINDLE

34. Inside Ring Setter's Clamp

A universal tool that allows all around accessibility for setting. Nine nylon inserts cover the entire range of ring sizes from #2-13. The head unscrews for alternative mounting in a vise.

ITEM #	DESCRIPTION
23-1271	RING SETTER'S CLAMP
23-1272	INSERTS FOR 23-1271
23-1273	BENCH PIN FOR 23-1271



23-1271



23-1273



35. Panavise

The universal vise is a precision unit where all movements are controlled by a single knob. Convenient positioning in all three planes make it perfect for filing, sawing, carving and setting. Jaws are of nylon, 2 1/2" wide and will not mar or scratch delicate surfaces. A vacuum base model of the vise operates by suction system and has additional adaptability to be mounted on any smooth surface. Replacement jaws are available.

ITEM #	DESCRIPTION
23-1281	STANDARD VISE
23-1282	VACUUM BASE VISE
23-1284	REPLACEABLE JAW



36. Bracelet Holder- Deluxe

All metal clamp, secures bracelet easily, eliminating the use of shellac. A relief on the diameter provides a space to nest the clasp.



ITEM #	DESCRIPTION
23-1061	BRACELET HOLDER 3 1/4"

37. Miter Cutter Jig

Alloy tool steel, hardened for wear resistance and long life. Vise holds thin sheet, round, square bar and tubing securely, for angle cuts at 45° or 90°. Additional adjustable stop for precise cuts to length. May be hand held or fixed in a bench vise.

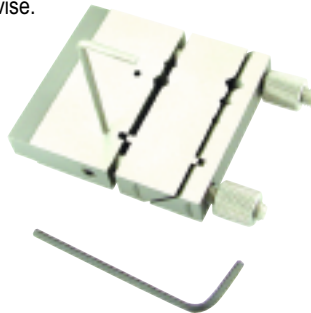

ITEM #	DESCRIPTION
23-1064	MITER JIG- 2" X 2 1/2" X 3/8" - FRANCE
23-1065	MITER JIG- 2" X 2 1/2" X 3/8" - BERGEON

39. Pearl Drilling Vise- France

Center drill pearls accurately without any mar on the surface. Quick clamp and release system. Thirteen cavities accommodate pearls or beads size #2-10m.



ITEM #	DESCRIPTION
23-1063	DRILLING VISE

40. Tube Cutter

High precision device to cut rods or tubing up to 5 mm round and 4 mm square. Secure metal stock in the V-groove holder by the built-in lock lever, insert the saw into the guide and cut. Identical lengths may be cut by setting the adjustable stop.

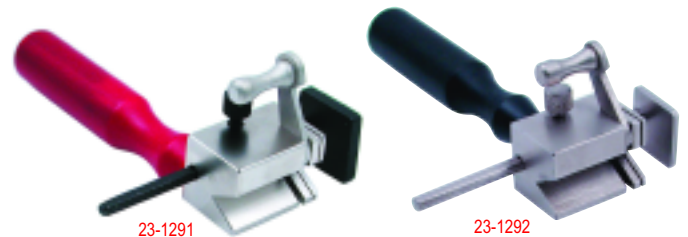

ITEM #	DESCRIPTION
23-1291	TUBE CUTTER- ITALY
23-1292	TUBE CUTTER- VALUE

38. Victorinox Knife - Swiss

The one and only all purpose stainless steel knife that finds use in almost all applications. Select from two models that have different features that include cutting blades, scissors, file, tweezers etc.

ITEM #	DESCRIPTION
23-1296	SWISS ARMY BASIC KNIFE
23-1297	SWISS ARMY KNIFE WITH 17 TOOLS

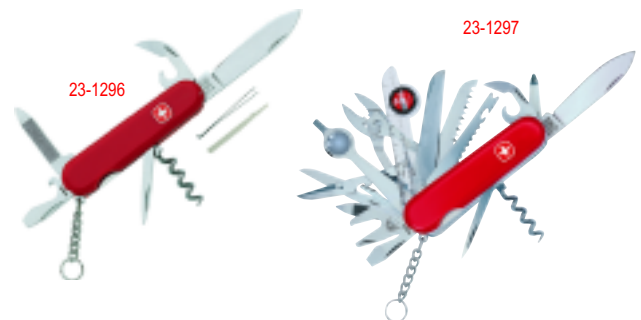



41. BenchMate

A versatile work holding system, loaded with features that instill confidence while stone setting and doing all kinds of jewelry repair. All steel construction with smooth teflon bearings contribute to a sturdy, rugged, rotating device that quick locks in any required position. Select from four kits.

#004-542 BenchMate Basic

Includes basic BenchMate holder, shellac pad, fixed mounting plate and hardware.



ITEM #	DESCRIPTION
23-1311	BENCHMATE BASIC

#004-555 BenchMate Deluxe

Includes basic BenchMate holder, shellac pad, narrow and wide solder fingers, third hand attachment, bench pin kit, fixed mounting plate and hardware.

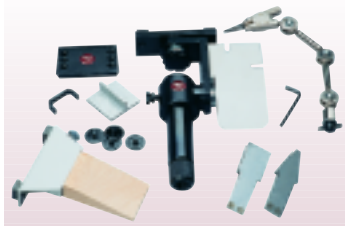

ITEM #	DESCRIPTION
23-1312	BENCHMATE DELUXE

#004-571 BenchMate Plus

Includes basic BenchMate holder, shellac pad, narrow and wide solder fingers, two third hand attachments, bench pin kit, 4" solder station, fixed mounting plate and hardware.



ITEM #	DESCRIPTION
23-1313	BENCHMATE PLUS

#004-674 Setter's Package

Includes basic BenchMate holder, shellac pad, bench pin kit, inside ring holder, fixed mounting plate and hardware.



ITEM #	DESCRIPTION
23-1314	SETTER'S PACKAGE



BenchMate Accessories

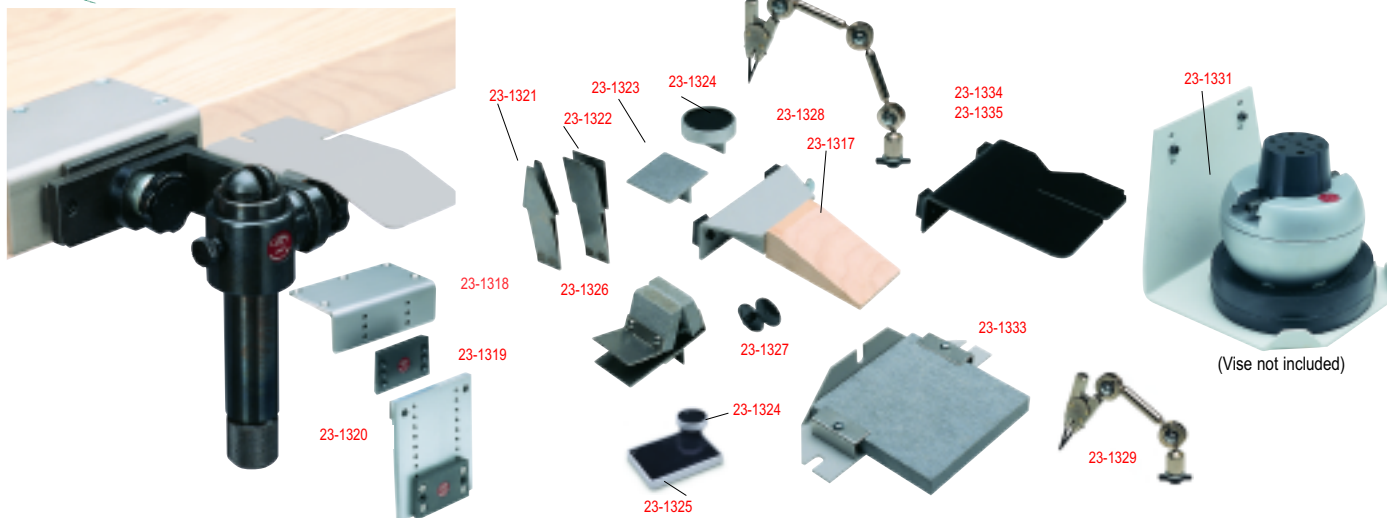

ITEM #	DESCRIPTION
23-1317	#004-556 BENCH PIN KIT
23-1318	#004-559 OPTIONAL MOUNTING ADAPTER
23-1319	#004-557 FIXED MOUNTING PLATE
23-1320	#004-666 ADJUSTABLE HEIGHT BRACKET
23-1321	#004-552 NARROW SOLDER FINGERS
23-1322	#004-553 WIDE SOLDER FINGERS
23-1323	#004-106 SHELLAC PAD
23-1324	#004-660 PITCH CUP
23-1325	#003-022 PITCH BOWL

ITEM #	DESCRIPTION
23-1326	#004-592 INSULATED SOLDER CLAMP
23-1327	#004-558 EXTRA PLASTIC JAWS (10 PCS)
23-1328	#004-546 THIRD HAND ATTACHMENT
23-1329	#004-646 SHORT THIRD HAND ATTACHMENT
23-1331	#004-578 STANDARD ENGRAVING VISE SHELF (Vise not included)
23-1333	#004-569 BENCHMATE SOLDER PAD ASSEMB.
23-1334	#004-680 SAWING PLATE RIGHT-HAND
23-1335	#004-684 SAWING PLATE LEFT-HAND



GRS 42. Inside Ring Holder

Versatile attachment that adds inside ring-holding capability to any BenchMate. Far more accessibility to work on the outside of all types of rings, wide, delicate or custom designed. Useful for settings of channel, bead and bezel. Complete set of collets- ring sizes #4-#13



ITEM #	DESCRIPTION
23-1361	#004-589 INSIDE RING HOLDER
23-1362	#004-616 EXTRA COLLET SET 23-1361

GRS 43. Multi-Purpose Vise

The Multi-Purpose Vise uses the easy "lift on / lift off" BenchMate mounting system. A unique feature of this vise allows you to rotate and adjust for any comfortable working angle. In addition the vise has pre-drilled holes for using various holding pins and clamps from the GRS 30 piece attachment set.



23-1319 -to be ordered separately see page # 48

ITEM #	DESCRIPTION
23-1341	#004-628 MULTI-PURPOSE VISE
23-1342	#003-520MPV ATTACHMENT SET FOR 23-1241

GRS 44. Contour Vise Jaws

Holds irregularly shaped parts. This jaw set fits the top holes of any GRS engraving vise. The hard rubber-lined jaws automatically conform to grip almost any shape using minimal clamping force.



ITEM #	DESCRIPTION
23-1343	#003-623 CONTOUR VISE JAWS

GRS 45. Knifemaker's Contour Vise

Hold knives securely for engraving work. Special chain-like liner jaws conform to unusual shapes with ease. Lined with a special hard rubber ribbon, these jaws grip securely without high clamping force.

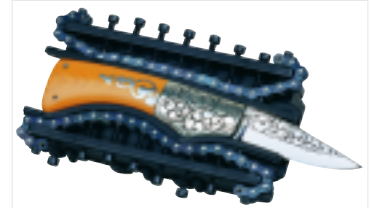

ITEM #	DESCRIPTION
23-1344	#003-622 KNIFEMAKER'S CONTOUR VISE

GRS 46. Microblock™ Ball Vise

The new GRS Microblock™ Ball Vise is the latest product in a broad line of precision work-holding tools. Machined from solid stainless steel and finished with a special low glare treatment to reduce eye strain, this new vise was designed for a unique combination of solid work support in a small and maneuverable size.



Weight - 4 lbs. (1.8kg) Ball diameter - 3.1" (80mm) Jaw width - 1.8" (46mm)
Jaw height - .87" (22mm) Max. opening - 2" (50mm)

ITEM #	DESCRIPTION
23-1351	#003-683 MICROBLOCK BALL VISE
23-1352	#003-684 M/BLOCK BALL VISE WITH 30 PCS SET
23-1353	#004-616 ENGRAVING BLOCK FELT PAD

GRS 47. Block Shelves

These shelves hold the GRS BenchMate engraving block below the front of your bench. The standard shelf has some vertical adjustment. The larger shelf has more height adjustment and a larger tray. Jewelers specially like this because the top of their block is the same height as their bench pin.

23-1318 -to be ordered separately see page # 48

Dimensions:

#004-578 : 7"W X 7" D X 7" H

#004-665 : 7"W X 8.25" D X 7" H

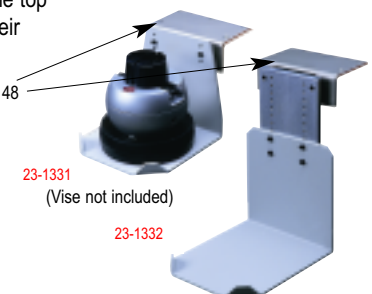

ITEM #	DESCRIPTION
23-1331	#004-578 STANDARD BLOCK SHELF
23-1332	#004-665 LARGE BLOCK SHELF



48. Dapping Block- Rubber

Resilient rubber dapping block for use with steel or wood punches. Useful for creating all types of shallow forms. Wt. 1 lb.

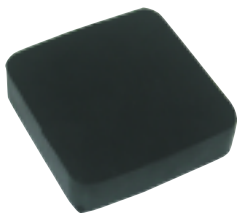

ITEM #	SIZE
29-1031	4" X 4" X 1"

49. Bracelet Mandrels

These mandrels are adaptable for shaping, stretching, and forming bracelets. Exterior surface is smoothly polished. Available in round and oval shapes.

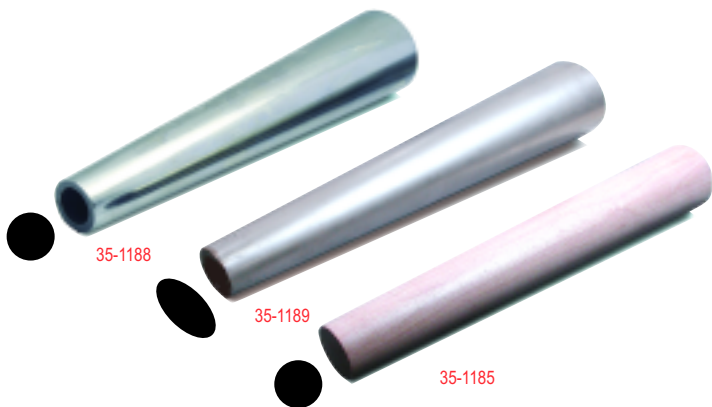

ITEM #	DESCRIPTION
35-1185	ROUND- 1½" X 3½" X 15"L -WOOD
35-1186*	OVAL (1⅝"/1⅞") X (3"/3½") X 15"L -WOOD
35-1188	ROUND 1¾" X 3½" X 15"L -STEEL
35-1189	OVAL (1⅝"/1⅞") X (3"/3½") X 15"L -STEEL

* Picture not shown

50. Bracelet and Ring Sizers- Wooden

Bracelet sizer: High quality polished wood sizer has three cutting edges to ream and shape bracelets to size. Measures circumference from 5 to 8.5" with millimeter equivalent.

Ring sizer: Designed for precision reaming of wax forms to exact sizes in US/ Euro /mm sizes from #1-14 including half sizes.



ITEM #	DESCRIPTION
59-5121	BRACELET SIZER
59-5122	RING SIZER -USA
59-5123	RING SIZER -EUROPEAN

51. Plier Organizers

Plier Holding Rack: An attractive hardwood, polished stand, with pairs of holes. Lets you keep your pliers handy and easily visible on your work bench. Upright storage eliminates damage to the jaw ends.

Wooden Plier Rack: Improve your efficiency by increasing work bench space with the addition of this shelf and drawer space saver. Convenient for storing small tools, parts and work articles.

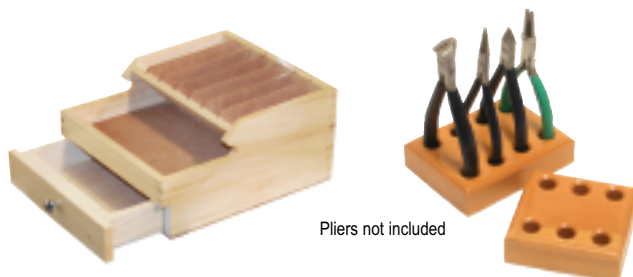

Pliers not included

ITEM #	DESCRIPTION
41-1511	6 HOLES- 3 PLIER HOLDER
41-1512	8 HOLES- 4 PLIER HOLDER
41-1513	10 HOLES- 5 PLIER HOLDER
41-1514	12 HOLES- 6 PLIER HOLDER
41-1515	16 HOLES- 8 PLIER HOLDER
41-1516	20 HOLES- 10 PLIER HOLDER
41-1517	RACK WITH DRAWER

52. Magnetic Tool Holder

An efficient organizer that instantly holds, yet quickly releases, small tools and implements. Mounts conveniently near your work bench.

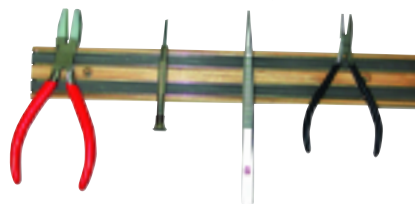

ITEM #	DESCRIPTION
23-1286	MAGNETIC TOOL HOLDER 12"
23-1287	MAGNETIC TOOL HOLDER 18"

53. Portable Worklight -LED

- Portable 7 LED worklight with bench clamp
- Sturdy powerful magnetic base
- Cool white light reduces eye fatigue
- Adjustable 9° articulated arm
- Powered by 3 -AAA batteries (included)



Magnetic Base

ITEM #	DESCRIPTION
39-2019	PORTABLE WORKLIGHT 7 LED
39-2021	POWER ADAPTER- 110V



BRUSHES

■ Bench Brush- Straight Soft	56
■ Bench Duster Brush	52
■ Brass Scratch Brush	56
■ Bristle Brushes- Plastic Center	54
■ Bristle Brushes-Hardwood Center - USA	55
■ Bristle Cup Brushes	52
■ Crimped Metal Wire Brushes	54
■ End Bristle Brushes	52
■ End Knot Bristle Brushes	52
■ End Wire Mounted Brushes	56
■ Glass Fiber Brush	52
■ Metal Cup Brushes	55
■ MiniMat Texturing Brushes	53
■ Mounted Brass Brushes	53
■ Mounted Steel Brushes	53
■ Mounted Wheel Bristle Brushes	56
■ Pen Type Scratch Brushes	56
■ Red Sable Brushes	56
■ Ring Bristle Brush	52
■ Scratch Brushes	56
■ Tapered Chuck for Brushes	54
■ Unmounted Brushes- Plastic Center	55
■ Unmounted Texturing Brushes	53
■ Unmounted Wheel Bristle Brushes	53
■ Unmounted Wire Brushes	52
■ Washout Brushes	

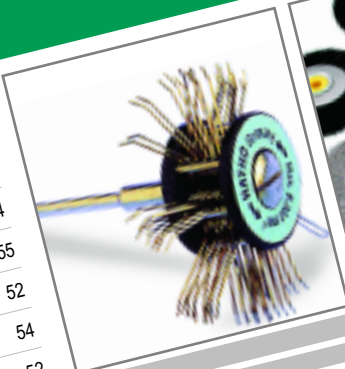

ikohe

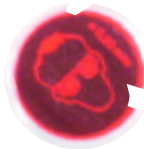

Jeweler's Resource by Bruce G. Knuth

A practical tool for the bench jeweler, student and retail jeweler. Easy-to-follow text and illustrations. Contains an extensive list of gems and gem properties; diagrams of gem-cutting styles; legal standards for diamond, gold and silver marketing; formulas and chemical preparations; and measurement conversion and comparison tables.

61-1031 (Spiralbound - 112 pages)

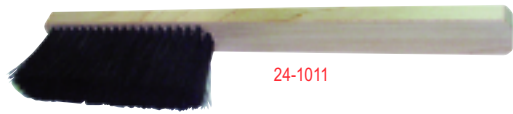

24-1011



24-1014



24-1015



24-1017



24-1018



5. End Bristle Brushes

- Use to clean grooves, curves and in between cleaves
 - End mounted on $\frac{3}{16}$ " shanks
 - Apply only light pressure
- Bx/12**



ITEM #	SIZE	GRADE
24-1101	$\frac{3}{16}$ " X $\frac{1}{4}$ "	SOFT
24-1102	$\frac{3}{16}$ " X $\frac{1}{4}$ "	STIFF
24-1103	$\frac{3}{16}$ " X $\frac{3}{8}$ "	SOFT
24-1104	$\frac{3}{16}$ " X $\frac{3}{8}$ "	STIFF

7. Bristle Cup Brushes

- Features metal hub construction
 - Inverted cone type brush for working over large areas
 - Mounted on $\frac{3}{32}$ " shanks
- Bx/12**



ITEM #	DIA.	GRADE
24-1107	$\frac{1}{2}$ "	STIFF
24-1108	$\frac{1}{2}$ "	SOFT

1. Bench Duster Brush

- A general purpose cleaning brush
- Natural bristles in a convenient wooden handle

ITEM #	DESCRIPTION	BRISTLE	LENGTH
24-1011	B/DUSTER-4 ROW	4" X $1\frac{1}{2}$ "	$9\frac{1}{4}$ "

2. Washout Brushes

- Durable nylon bristles, set in rows, mounted in wood or bone

ITEM #	DESCRIPTION	BRISTLE	LENGTH
24-1014	BONE HANDLE	$3\frac{1}{2}$ " X $\frac{3}{4}$ "	$6\frac{1}{4}$ "
24-1015	WOODEN HANDLE	$3\frac{1}{2}$ " X $\frac{3}{4}$ "	$10\frac{1}{2}$ "

3. Scratch Brushes

- Firmly anchored bristles of either brass or steel
- Useful when cleaning work with or without solutions

ITEM #	DESCRIPTION	BRISTLE	LENGTH
24-1017	STEEL-4 ROW	$4\frac{1}{2}$ " X $\frac{3}{4}$ "	$8\frac{5}{8}$ "
24-1018	BRASS-4 ROW	$4\frac{1}{2}$ " X $\frac{3}{4}$ "	$8\frac{5}{8}$ "

4. End Knot Bristle Brushes

- A small diameter brush, with hard bristles
- Use with or without polishing compounds

ITEM #	DESCRIPTION	D X L	LENGTH
24-1021	BRISTLE KNOT- 5	$\frac{1}{4}$ " X 1"	$2\frac{3}{4}$ "
24-1022	BRISTLE KNOT-7	$\frac{3}{8}$ " X 1"	$2\frac{3}{4}$ "
24-1023	BRISTLE KNOT-10	$\frac{1}{2}$ " X 1"	$2\frac{3}{4}$ "

6. End Wire Mounted Brushes

- Ideal for use in confined work areas
 - Made of soft brass or hard steel
 - Mounted on $\frac{3}{16}$ " shanks
 - Size $\frac{3}{16}$ " X $\frac{1}{4}$ "
- Bx/12**

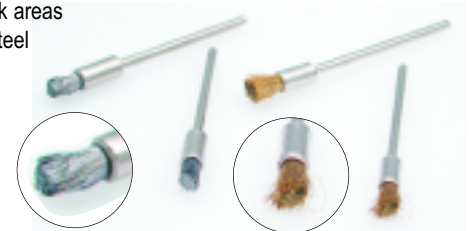

ITEM #	TYPE	GRADE
24-1201	STRAIGHT	BRASS
24-1202	CRIMPED	BRASS
24-1203	STRAIGHT	STEEL
24-1204	CRIMPED	STEEL

8. Metal Cup Brushes

- All metal construction
 - Use for scouring and cleaning
 - Mounted on $\frac{3}{32}$ " shanks
- Bx/12**



ITEM #	SIZE	GRADE
24-1207	$\frac{1}{2}$ "	BRASS
24-1208	$\frac{1}{2}$ "	STEEL



9. Unmounted Wheel Bristle Brushes- Value

- Metal hub bristle brushes in different grades • Narrow profiles to suit individual requirements
- All with 1/8" arbor hole **Bx/12**

ITEM #	SIZE	GRADE	ITEM #	SIZE	GRADE
24-1111	3/4"	EX-SOFT	24-1115	1"	EX-SOFT
24-1112	3/4"	SOFT	24-1116	1"	SOFT
24-1113	3/4"	MEDIUM	24-1117	1"	MEDIUM
24-1114	3/4"	STIFF	24-1118	1"	STIFF



10. Mounted Wheel Bristle Brushes- Value

- Four densities for different finishes • Solid metal hub design for production • Use with flexshaft
- Mounted on 3/32" shank **Bx/12**

ITEM #	SIZE	GRADE	ITEM #	SIZE	GRADE
24-1121	3/4"	EX-SOFT	24-1125	1"	EX-SOFT
24-1122	3/4"	SOFT	24-1126	1"	SOFT
24-1123	3/4"	MEDIUM	24-1127	1"	MEDIUM
24-1124	3/4"	STIFF	24-1128	1"	STIFF



Tapered chuck for brushes
see pg# 56



11. Unmounted Wire Brushes

- Fine straight or crimped wire brushes for working detailed areas in jewelry
- Choice of two materials, steel or brass • Wheels may be used for gentle or vigorous working
- All with 1/8" arbor hole **Bx/12**

Brass

ITEM #	DESCRIPTION
24-1211	STRAIGHT- 3/4"
24-1212	CRIMPED- 3/4"
24-1213	STRAIGHT-1"
24-1214	CRIMPED-1"
24-1237	CRIMPED- 3/4" GERMANY
24-1238	CRIMPED- 1" GERMANY

Steel

ITEM #	DESCRIPTION
24-1215	STRAIGHT- 3/4"
24-1216	CRIMPED- 3/4"
24-1217	STRAIGHT-1"
24-1218	CRIMPED-1"
24-1239	CRIMPED- 3/4" GERMANY
24-1240	CRIMPED- 1" GERMANY



12. Mounted Brass Brushes

- Small diameter crimped or straight brass wire brushes • Crimped wire creates a matte finish
- Ideal for brushed finish on jewelry pieces • Mounted on 3/32" shank

Bx/12

ITEM #	DESCRIPTION	ITEM #	DESCRIPTION
24-1221	CRIMPED 3/4"	24-1223	STRAIGHT-3/4"
24-1222	CRIMPED 1"	24-1224	STRAIGHT- 1"
24-1225	CRIMPED 3/4" GERMANY		
24-1226	CRIMPED 1" GERMANY		



13. Mounted Steel Brushes

- Straight or crimped firm steel brushes fixed in a steel hub • Suitable for tough scouring
- Works efficiently for initial removal of high spots and uneven surfaces • Mounted on 3/32" shank

Bx/12

ITEM #	DESCRIPTION	ITEM #	DESCRIPTION
24-1231	CRIMPED 3/4"	24-1233	STRAIGHT-3/4"
24-1232	CRIMPED 1"	24-1234	STRAIGHT- 1"
24-1227	CRIMPED 3/4" GERMANY		
24-1228	CRIMPED 1" GERMANY		





14. Unmounted Brushes- Plastic Center-Germany

- Tightly packed bristle brush, features a plastic center • Available in bristle and crimped metal wire
- Recommended for cleaning and polishing • Arbor hole $\frac{1}{8}$ "

Bristle

ITEM #	Ø X TRIM	GRADE
24-1141	2" X $\frac{5}{8}$ "	STIFF
24-1142	2" X $\frac{5}{8}$ "	MEDIUM
24-1143	2" X $\frac{5}{8}$ "	SOFT

Metal Wire

ITEM #	Ø X TRIM	TYPE
24-1241	2" X $\frac{5}{8}$ "	BRASS
24-1242	2" X $\frac{5}{8}$ "	STEEL

15. Bristle Brushes- Plastic Center-Germany

- Pure black bristle brushes • Plastic center eliminates scratches or mars on jewelry
- C-converging • Use tapered spindles
- Arbor hole $\frac{1}{8}$ "

ITEM #	Ø	ROW	HUB Ø
24-1146	80MM	3R	40MM
24-1147	80MM	4R	40MM

16. Crimped Metal Wire Brushes-Germany

- Soft brass or steel bristles, different row types, all with hardwood hubs • Use on tapered spindles
- Very gentle for scouring of all types of metal • Leaves a matte finish • Wire size 0.10mm.

Steel Wire Ø : 0.1mm

ITEM #	Ø X HUB	ROWS
24-1311	3" X $1\frac{1}{4}$ "	2
24-1312	3" X $1\frac{1}{4}$ "	3
24-1313	3" X $1\frac{1}{4}$ "	4

ITEM #	Ø X HUB	ROWS
24-1316	4" X $1\frac{1}{2}$ "	2
24-1317	4" X $1\frac{1}{2}$ "	3
24-1318	4" X $1\frac{1}{2}$ "	4

Brass Wire Ø : 0.1mm

ITEM #	Ø X HUB	ROWS
24-1331	3" X $1\frac{1}{4}$ "	2
24-1332	3" X $1\frac{1}{4}$ "	3
24-1333	3" X $1\frac{1}{4}$ "	4

ITEM #	Ø X HUB	ROWS
24-1336	4" X $1\frac{1}{2}$ "	2
24-1337	4" X $1\frac{1}{2}$ "	3
24-1338	4" X $1\frac{1}{2}$ "	4

17. Wheel Bristle Brushes-Germany

- Metal hub bristle brushes in different grades • Narrow profiles to suit individual requirements
- All with $\frac{1}{8}$ " arbor hole Bx/12

Un-Mounted

ITEM #	SIZE	GRADE
24-1451	$\frac{3}{4}$ "	SOFT
24-1452	$\frac{3}{4}$ "	MEDIUM
24-1453	$\frac{3}{4}$ "	STIFF
24-1454	1"	SOFT
24-1455	1"	MEDIUM
24-1456	1"	STIFF

Mounted

ITEM #	SIZE	GRADE
24-1461	$\frac{3}{4}$ "	SOFT
24-1462	$\frac{3}{4}$ "	MEDIUM
24-1463	$\frac{3}{4}$ "	STIFF
24-1464	1"	SOFT
24-1465	1"	MEDIUM
24-1466	1"	STIFF



18. Bristle Brushes-Hardwood Center - USA

• COCKER-WEBER SUPERIOR CHUNGKING BRISTLE BRUSHES

- Pure black bristle brushes for jewelry applications • Seasoned wood hubs
- Arbor hole 1/4" • Use tapered spindles

ITEM #	Ø X TRIM	STYLE	ROWS
STANDARD			
24-1151	1 7/8" X 5/8"	1A	1R- U
24-1152	1 7/8" X 1/2"	1B	1R- U
24-1153	1 7/8" X 3/8"	1C	1R- U
24-1154	1 7/8" X 5/8"	2A	2R- C
24-1155	1 7/8" X 1/2"	2B	2R- C
24-1156	1 7/8" X 3/8"	2C	2R- C
24-1161	1 1/4" X 5/8"	6A	2R- C
24-1162	1 1/4" X 3/8"	6C	2R- C

SUPERIOR : Stiffer and long lasting

24-1173	1 7/8" X 3/4"	3B	3R- C
24-1174	1 7/8" X 5/8"	3A	3R- C
24-1175	1 7/8" X 3/8"	3C	3R- C
24-1181	1 7/8" X 5/8"	4A	4R- C
24-1182	1 7/8" X 1/2"	4B	4R- C
24-1183	1 7/8" X 3/8"	4C	4R- C
24-1186	1 1/4" X 3/8"	6C	2R- C
21-1191	1 1/2" X 3/4"	11	3R- C

The more rows the stiffer the brush. Use with all types of polishing compounds

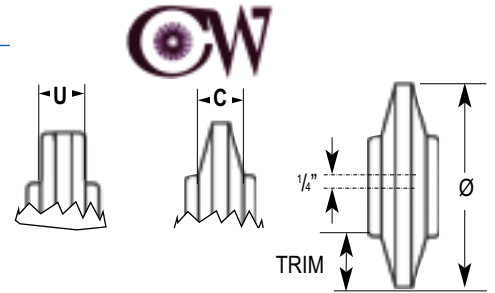

19. Unmounted Texturing Brushes- Germany

- The fine wire diameter of these brushes impart a satin, matte or coarse cut finish
- Mount on a right hand tapered spindle

ITEM #	SIZE	WIRE Ø	GRADE
24-1412	100 X 25MM	0.60MM	COARSE
24-1413	100 X 25MM	0.45MM	MEDIUM
24-1414	100 X 25MM	0.30MM	FINE
24-1415	100 X 25MM	0.20MM	EX-FINE

20. MiniMat Texturing Brushes- Germany

- Achieve a textured finish quickly and easily
- Steel wires of different diameters are affixed on a plastic hub
- Maximum speed 5,000 rpm.

MiniMat- Mounted on 1/2" shank

ITEM #	WIRE Ø	GRADE
24-1422	0.60MM	COARSE
24-1423	0.45MM	MEDIUM
24-1424	0.30MM	FINE

MaxiMat Pro- Unmounted

- For right hand tapered spindles

ITEM #	WIRE Ø	GRADE	COLOR
24-1432	0.60MM	COARSE	GREEN
24-1433	0.45MM	MEDIUM	YELLOW
24-1434	0.30MM	FINE	RED
24-1435	0.20MM	X-FINE	BLUE

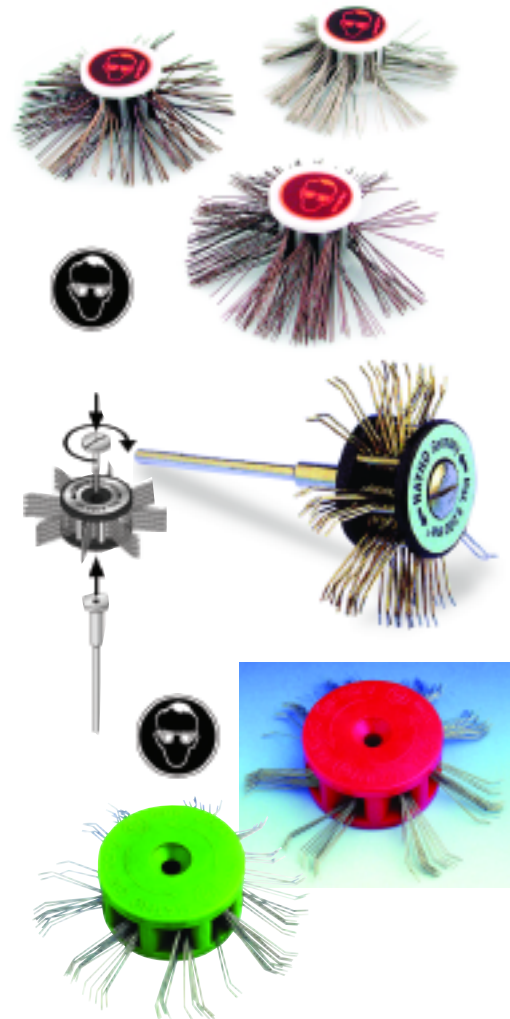
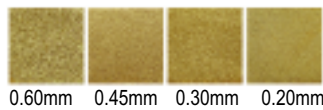



21. Hand Brush-Nylon

- All purpose grip handle brush with stiff nylon bristles
- Useful for cleaning hands and fingernails
- Ideal for removing investment



ITEM #	DESCRIPTION
24-1031	HAND BRUSH- 4" X 1 1/4"

22. Ring Bristle Brush

- Cone shaped brush for cleaning inside of rings
- Nose is trimmed for cleaning filigree
- Use on a right handed tapered spindle
- Overall length 6 1/2"



ITEM #	DESCRIPTION
24-1036	BRISTLE LENGTH - 4 1/2"

23. Glass Fiber Brush

- Glass fiber bristles wrapped with a cotton binder
- As wear occurs remove binder to expose new bristles
- Useful to clean oxides, scale and residue



ITEM #	DESCRIPTION
24-1041	GLASS FIBER BRUSH -8"

24. Brass Scratch Brush

- Crimped brass bristles
- Use for cleaning prior to soldering or plating
- Adjustable for trim length from stiff to soft



ITEM #	DESCRIPTION
24-1034	SCRATCH BRUSH- 2 1/4" X 1"

25. Bench Brush- Straight Soft

- The perfect brush for cleaning at goldsmith's benches
- Made from soft goat hair
- Overall length 6 1/2"



ITEM #	DESCRIPTION
24-1038	BRISTLE LENGTH - 2 1/4"

26. Tapered Chuck for Brushes

- Fits directly to the shaft ends of bench polishers
- Right and left hand screw ends

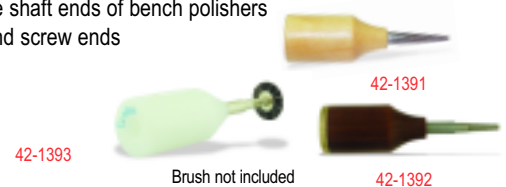

ITEM #	DESCRIPTION
42-1391	WOODEN-RIGHT HAND
42-1392	PLASTIC-RIGHT HAND
42-1393	PLASTIC-LEFT HAND

27. Pen Type Scratch Brushes

- Use steel or brass styles for removing rust or corrosion in hard to reach areas
- Bristles are firmly secured in metal ferrules • Convenient pen type grip



Brushes

ITEM #	TYPE	LENGTH
24-1051	STEEL	4 1/2"
24-1052	BRASS	4 1/2"
24-1053	NYLON	4 1/2"
24-1054	FIBERGLASS	4 1/2"

Refills -Set of 6- bx/6

ITEM #	TYPE	LENGTH
24-1061	STEEL	1 1/4"
24-1062	BRASS	1 1/4"
24-1063	NYLON	1 1/4"
24-1064	F/GLASS	1 1/4"

28. Red Sable Brushes

Pure sable hair bristles, crimped in ferrules, mounted in a convenient sized pencil grip. Extremely fine points, in assorted sizes for art and design work. Size 3/0 is smallest and #7 is the largest. Bx/12



ITEM #	SIZE
24-1081	3/0
24-1082	2/0
24-1083	0
24-1084	1
24-1085	2

ITEM #	SIZE
24-1086	3
24-1087	4
24-1088	5
24-1089	6
24-1090	7



BUFFS

- 3M® FX Polishing Wheels 66
- 3M® Cut, Deburring & Polish Wheels 67
- 3M® General Purpose Wheels 67
- 3M® Sanding Sponges 60
- 3M® Radial Brushes 65
- 3M® Scotchbrite Pads 60
- 3M® Unitized Wheels 66
- Adapters and Wheel Flanges 67
- Artifex Elastic Bond Wheels 64
- Artifex Inside Ring Polishers 68
- Bergeon® Satin Finish Wheels 63
- Chamois Buffs 63
- Cotton String Buffs 58
- DECOZE Split & Beveled Felt Laps 64
- Felt Bangle Buffs 64
- Felt Combination Buffs 58
- Felt Wheels 61, 62
- Finex Muslin Buffs- L/C 61
- Finex Muslin Knife Edge Buffs- L/C 63
- Goblet Buffs 67
- IkFlex Elastic Bond Wheels 68
- IKOHE Satin Flap Wheels 64
- Inside Felt Ring Buffs 64
- Inside Ring-Sanders 58
- Knife Edge Felt Wheels 63
- Leather Strap 60
- Midget Buffs-Mounted 62
- Midget Muslin Buffs-Unmounted 62



- Mounted Felt Bobs 59
- Muslin Loose Buffs- Lead Center 61
- Norton® Beartex Wheel 60
- Paramount® Felt Ply Buffs- L/C 59
- Paramount® Finest Muslin Buffs 80/80 59
- Paramount® Split & Beveled Felt Laps 58
- Paramount® Yellow T/Muslin Buffs 86/80 59
- Radial Bristle Discs 65
- Red Treated Muslin Buffs for Platinum 61
- Satin Finish Wheels 60
- Solid Felt Ring Buffs 64
- Tapered Muslin Buffs 63
- Yellow Treated Knife Edge Buffs- L/C 62
- Yellow Treated Muslin Buffs 62



ikohē

3M®

ARTIFEX

NORTON

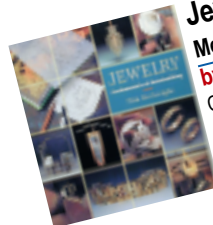

Jewelry: Fundamentals of Metalsmithing by Tim McCreight

Clear and insightful instruction on jewelry making methods for the beginner or intermediate metalsmith. Features various techniques including fabricating, surface treatments, joining, finishing, stone setting, chain making, mechanisms and casting. Color photos of finished pieces are used to demonstrate each technique.

61-1073 (Hardcover – 143 pages)



1. Felt Wheels

- Small compressed wool felt wheels for general purpose polishing • Easy to shape and profile
- All with pin hole centers

Midget Wheels

ITEM #	Ø X T	GRADE
25-1011	1/2" X 1/8"	SOFT
25-1014	1" X 1/8"	SOFT
25-1015	1" X 1/4"	SOFT

Square Edge Wheels

ITEM #	Ø X T	GRADE
25-1031	4" X 1/2"	MEDIUM
25-1035	6" X 1/2"	HARD

2. Knife Edge Felt Wheels

- Perfectly formed and trued, for polishing narrow grooves and slots • Pin hole centers
- Use on tapered spindle polishers
- Small sizes can be used in flexible shaft machine

ITEM #	Ø	GRADE
25-1041	1"	MED. HARD
25-1042	1 1/4"	MED. HARD
25-1044	2"	MED. HARD
25-1047	6"	MED. HARD
25-1051	3"	ROCK HARD
25-1052	4"	ROCK HARD

ITEM #	Ø	GRADE
25-1061	1"	FLINT HARD
25-1062	2"	FLINT HARD
25-1063	3"	FLINT HARD
25-1064	4"	FLINT HARD

3. Paramount® Split & Beveled Felt Laps

- Premium quality felt • Four slots provide clear visibility while polishing • Accurately balanced
- All with pin hole for fitting on tapered spindles

GRADE	6" X 1/2"	7" X 1/2"	8" X 1/2"
MEDIUM	25-1071	25-1075	25-1079
HARD	25-1072	25-1076	25-1080
ROCK HARD	25-1073	25-1077	25-1081
FLINT HARD	25-1074	25-1078	25-1082

4. DECOZE® Split & Beveled Felt Laps

- Premium quality felt • Four slots provide clear visibility while polishing • Accurately balanced
- All with pin hole for fitting on tapered spindles

GRADE	6" X 1/2"	7" X 1/2"	8" X 1/2"
MEDIUM	25-1101	25-1105	25-1109
HARD	25-1102	25-1106	25-1110
ROCK HARD	25-1103	25-1107	25-1111
FLINT HARD	25-1104	25-1108	25-1112



Split Lapping Machine
See page # 228





5. Paramount® Felt Ply Buffs- Leather Center

- Unique and durable with a super fast polishing action
- Stitched in rows to maintain a firm shape
- Compressed to eliminate porosity
- Ultra shine on precious metals and platinum

ITEM #	DIA.	PLY	STITCH	GRADE
25-1117	6"	6	4 ROWS	SOFT
25-1118	6"	6	4 ROWS	MEDIUM
25-1119	6"	6	4 ROWS	HARD



6. Paramount® Yellow Treated Muslin Buffs 86/80

Specially treated to enable fast cutting, these buffs have an inherent stiffness to withstand rugged use. Additional stitching gives the added advantage of maintaining trueness. Available in leather or shellac centers.

DIA.	PLY	STITCH	LEATHER	SHELLAC
4"	40	3 ROWS	25-1213	25-1221
5"	40	3 ROWS	25-1214	25-1222
5"	50	3 ROWS	25-1215	25-1223
6"	50	4 ROWS	25-1216	25-1226
6"	60	4 ROWS	25-1218	25-1228



7. Paramount® Finest Muslin Buffs 80/80

These buffs have a denser weave that eliminates stringing. Far superior than the regular type, these buffs give a more delicate sheen to the surface. Available in leather or shellac centers.

DIA.	PLY	STITCH	LEATHER	SHELLAC
4"	50	3 ROWS	25-1231	25-1236
5"	50	3 ROWS	25-1232	25-1237
6"	50	4 ROWS	25-1233	25-1238



8. Mounted Felt Bobs

- Treated compressed felt in various shapes and styles
- Ideal for use with flexshafts
- Easily interchangeable
- Mounted on 3/32" shanks Bx/12

STYLE	FLAME	ROUND	CONE	BULLET	CYLINDER	SQ/ EDGE
SIZE	3/8" X 3/4"	5/16" X 3/8"	1/4" X 3/4"	5/16" X 5/8"	3/8" X 5/8"	7/8" X 1/4"
ITEM #	25-1131	25-1132	25-1133	25-1134	25-1135	25-1136

9. Unmounted Felt Cones

- High density felt cones to polish the inner surfaces of work pieces
- All with pin holes
- Use with screw mandrels

ITEM #	Ø X T
25-1141	1/4" X 1/2"
25-1142	1/2" X 1"
25-1143	3/4" X 1 1/2"



FINISHING COMPOUNDS

Buffing polishing compounds are available for pre-polishing, cut and polish, final polishing and platinum polishing. See pg# 68 & 224



BUFFS



10. 3M® Sanding Sponges

- Sponges may be shaped or trimmed to fit any type of surface
- Ideal for finishing and polishing engraved designs

Bx/20



ITEM #	SIZE	GRADE
25-1611	4 1/2" X 5 1/2"	MEDIUM
25-1612	4 1/2" X 5 1/2"	FINE
25-1613	4 1/2" X 5 1/2"	SUPER FINE
25-1614	4 1/2" X 5 1/2"	ULTRA FINE
25-1615	4 1/2" X 5 1/2"	MICRO FINE

12. Satin Finish Buffs

- Graded abrasive particles finely dispersed on a long lasting fiber structure
- Buffs generate a uniform satin finish on all precious metals
- Reinforced leather centers
- Mount on tapered spindle polishers



ITEM #	Ø	PLY	COLOR	GRADE
25-1411	4"	2	TAN*	COARSE
25-1412	4"	2	BROWN*	MEDIUM
25-1413	4"	2	PLUM*	FINE
25-1414	4"	3	TAN*	COARSE
25-1415	4"	3	BROWN*	MEDIUM
25-1416	4"	3	PLUM*	FINE

* Color may vary



14. Norton® Beartex Satin Wheels

- Cost effective wheel for deburring, cleaning and polishing of metals
- Uniform non-woven construction
- Use on a wide variety of shapes and contours
- Highly durable for general applications
- Color may vary

ITEM #	SIZE	GRADE
25-1431	3" X 3/4" X 1/4"	COARSE
25-1432	3" X 3/4" X 1/4"	MEDIUM
25-1433	3" X 3/4" X 1/4"	FINE

ITEM #	SIZE	GRADE
25-1437	6" X 1" X 1/2"	COARSE
25-1438	6" X 1" X 1/2"	MEDIUM
25-1439	6" X 1" X 1/2"	FINE

15. Midget Buffs- Mounted- Germany

- Small diameter buffs in different materials
- Mounted on 3/32" mandrels
- Use on flexshaft with polishing compound
- High speeds are recommended for a fine finish

ITEM #	Ø X T	TYPE
25-1091	1" X 3/16"	CHAMOIS
25-1092	1" X 3/16"	MUSLIN
25-1093	3/4" X 3/8"	COTTON

ITEM #	Ø X T	TYPE
25-1096	1" X 1/4"	SATIN -F
25-1097	1" X 1/4"	SATIN -M
25-1098	1" X 1/4"	SATIN -C

11. 3M® Scotchbrite Pads

- Uniform fast cutting action, excellent for satin and matte finishes
- Create your own flap wheels to get a consistent finish

Bx/20

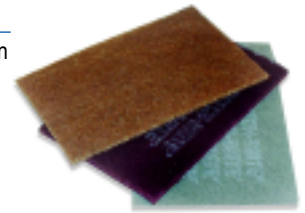

13. Satin Finish Wheels

- Produces a satin finish on all types of precious metals
- Medium density wheels



ITEM #	GRADE	Ø X T X AH
25-1421	MEDIUM	4" X 1" X 3/8"
25-1422	FINE	4" X 1" X 3/8"
25-1423	X-FINE	4" X 1" X 3/8"

Eliminate the use of messy compounds, select a satin wheel for a consistent finish. The open pore structure combined with the abrasive fiber allows for cool cutting action.





16. Muslin Loose Buffs- Lead Center

- Unsewn fine weave muslin buffs with combed edges • Use with rouge polishing compounds
- Lead centers • Fit on tapered spindle polishers

ITEM #	DIA.	PLY
25-1251	3"	36
25-1252	3"	54
25-1253	4"	54

ITEM #	DIA.	PLY
25-1254	5"	54
25-1255	6"	54
25-1256	6"	63



17. Finex Muslin Buffs Loose & Combed- Leather Center

- Finest muslin loose buffs with combed edges • Use with rouge or Zam®
- Fit on tapered spindle polishers

ITEM #	DIA.	PLY
25-1261	3"	35
25-1262	4"	40
25-1263	4"	50

ITEM #	DIA.	PLY
25-1264	5"	45
25-1265	5"	50
25-1266	6"	50



18. Finex Muslin Knife Edge Buffs- Leather Center

- Superior quality muslin buffs for polishing crevices and narrow slots
- Stitched in rows to promote a compact and rigid edge • Fit on tapered spindle polishers

ITEM #	DIA.	PLY
25-1271	3"	12
25-1272	4"	12

ITEM #	DIA.	PLY
25-1273	5"	12
25-1274	6"	12



19. Red* Treated Muslin Buffs for Platinum

- Tightly sewn, trued and combed muslin buff • Treated for good cutting action and compound retention
- Effective with compounds for polishing platinum • Leather or shellac centers
- Fit on tapered spindle polishers

DIA.	PLY	STITCH	LEATHER	SHELLAC
3"	35	3 ROWS	25-1278	25-1288
4"	40	3 ROWS	25-1279	25-1289
4"	50	3 ROWS	25-1280	25-1290
5"	45	3 ROWS	25-1281	25-1291
5"	50	3 ROWS	25-1282	25-1292
6"	30	4 ROWS	25-1283	25-1293
6"	50	4 ROWS	25-1284	25-1294
6"	60	4 ROWS	25-1285	25-1295
7"	50	4 ROWS	25-1286	25-1296
7"	70	4 ROWS	25-1287	25-1297

* Color may vary





20. Finex Muslin Buffs-Stitched & Combed

- Soft cotton flannel buffs for final polishing • Stitched firm with combed faces
- Use with Tripoli and bobbing compounds • Leather or shellac centers • Fit on tapered spindle polishers

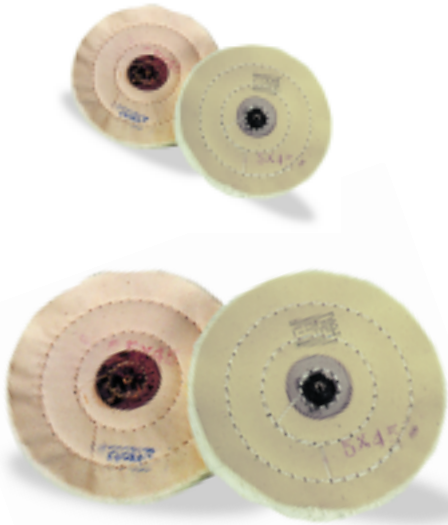

DIA.	PLY	STITCH	LEATHER	SHELLAC
2"	30	3 ROWS	—	25-1531
3"	35	3 ROWS	25-1504	25-1534
4"	40	3 ROWS	25-1508	25-1538
4"	50	3 ROWS	25-1509	25-1539
5"	45	3 ROWS	25-1514	25-1544
5"	50	3 ROWS	25-1515	25-1545
6"	30	4 ROWS	25-1518	25-1548
6"	50	4 ROWS	—	25-1550
6"	60	4 ROWS	25-1521	25-1551
6"	70	4 ROWS	—	25-1552
7"	50	4 ROWS	25-1524	25-1554
7"	70	4 ROWS	25-1526	25-1556

Other standard sizes are available on request

21. Yellow Treated Muslin Buffs

- Specially treated muslin buffs are long lasting • Fine combed edges
- Withstands heavy or rough work • Leather or shellac centers • Fit on tapered spindle polishers



DIA.	PLY	STITCH	LEATHER	SHELLAC
3"	35	3 ROWS	25-1561	25-1581
4"	40	3 ROWS	25-1564	25-1584
5"	50	3 ROWS	25-1569	25-1589
6"	50	4 ROWS	25-1573	25-1595
6"	70	4 ROWS	—	25-1597
7"	60	4 ROWS	25-1579	

Other standard sizes are available on request

22. Yellow Treated Knife Edge Buffs- Leather Center

- Chemically treated fine woven muslin buffs
- Excellent compound retention
- Thin edge allows the polishing of narrow valleys and grooves
- Fit on tapered spindle polishers



ITEM #	DIA.	PLY
25-1601	3"	12
25-1602	4"	12
25-1603	5"	12
25-1604	6"	12

23. Midget Muslin Buffs-Unmounted

- Soft muslin buffs stitched to ensure firmness at high speeds
- Convenient to use on flexshafts
- Use with all type of rouge
- Excellent for use on gold and silver



ITEM #	DIA.	STITCH	COLOR
25-1381	7/8"	1 ROW	WHITE 16P
25-1382	1"	1 ROW	WHITE 16P
25-1383	1"	2 ROWS	WHITE 16P
25-1388	1"	1 ROW	YELLOW 16P
25-1389	1"	2 ROWS	YELLOW 16P



24. Tapered Muslin Buffs

- Cone shaped buffs for finishing the inner surfaces of work pieces
- Performs well with all polishing compounds
- Fit on tapered spindle polishers



ITEM #	DIA.
25-1391	2"
25-1392	3"
25-1393	3½"

26. Goblet Buffs

- Use for polishing the insides of goblets
- Fine muslin stitched and spherically shaped
- Performs well with all polishing compounds
- Fit on tapered spindle polishers



ITEM #	DIA.
25-1821	2"
25-1822	3"
25-1823	4"

28. Chamois Buffs

- Durable, long lasting, soft leather stitched buffs
- Ultra fine finishing on precious metal and platinum
- Performs well with all polishing compounds
- Fit on tapered spindle polishers



ITEM #	DIA.	PLY
25-2115	3"	12
25-2116	4"	12

30. Leather Strap

- Genuine cowhide leather strap
- Use for holding chains and rings
- Protects fingers from heat
- Available in 150 feet rolls



ITEM #	DESCRIPTION
25-2111	ROLL 1" X 1/8" - 150 FT

25. Cylinder Buffs

- Tube shaped buffs for inside finishing
- Use with all types of polishing compounds
- Fit on tapered spindle polishers



ITEM #	Ø X T
25-1811	2" X 2"
25-1812	3" X 3"
25-1813	3½" X 3½"

27. Cotton String Buffs

- Extremely soft with lose strings fitted to a wooden hub
- Ideal for an ultra fine finish on precious metals
- Performs well with all polishing compounds
- Fit on tapered spindle polishers



ITEM #	Ø X T
25-1831	4" X 2"
25-1832	3" X 2"

29. Cotton Tapered Ring Buffs

- Soft cotton buffs for polishing the inside of rings
- String wire nose for cleaning
- Felt nose for polishing
- Fit on tapered spindle polishers



ITEM #	TAPERED	NOSE TYPE
25-1836	22-28MM	FELT
25-1837	22-28MM	STRAIGHT
25-1838	22-28MM	STRING

31. Slimline Buffs

- Fit on tapered spindle polishers
- Max Speed 1400 rpm.
- 2" diameter

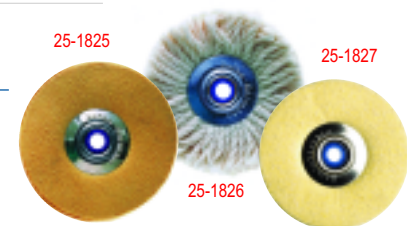

ITEM #	DESCRIPTION
25-1825	SLIMLINE BUFF 2"- LEATHER CHAMOIS
25-1826	SLIMLINE BUFF 2"- COTTON THREAD
25-1827	SLIMLINE BUFF 2"- MICROFIBER LEATHER



32. Solid Inside Ring Sanders-for Pre-Finishing

- For initial cutting on castings • Mounted on wood mandrel • Drilled for tapered spindle
- Overall length 2"

ITEM #	DESCRIPTION
25-1839	RING SANDER $\frac{3}{4}''-\frac{5}{8}''$ - 2AMEXL
25-1840	RING SANDER $\frac{3}{4}''-\frac{5}{8}''$ - 5AFCP



33. Artifex Inside Ring Polishers

- Unmatched in quality, these ring polishers outlast regular conventional polishers
- Polishing can be controlled to the finest degree • Fit on tapered spindle polishers

ITEM #	TAPER	GRIT	LENGTH
25-1841	15-22MM	150	65MM
25-1842	15-22MM	250	65MM



34. Solid Felt Ring Buffs

- Pure wool compressed felt buffs for polishing inside of rings
- Performs well with all polishing compounds • Fit on tapered spindle polishers

Length: 3"

ITEM #	TAPER	GRADE
25-1845	$\frac{3}{4}''-\frac{9}{16}''$	REGULAR
25-1846	$\frac{3}{4}''-\frac{9}{16}''$	HARD

Length: 4"

ITEM #	TAPER	GRADE
25-1847	$\frac{7}{8}''-\frac{5}{8}''$	REGULAR
25-1848	$\frac{7}{8}''-\frac{5}{8}''$	HARD



35. Inside Felt Ring Buffs- Tapered

- Pure wool felt buffs mounted on tapered wooden mandrel
- Performs well with all polishing compounds • Fit on tapered spindle polishers

Regular

ITEM #	TAPER	LENGTH
25-1861	$\frac{9}{16}''-\frac{5}{16}''$	3"
25-1862	$\frac{3}{4}''-\frac{9}{16}''$	3"
25-1863	$\frac{7}{8}''-\frac{5}{8}''$	4"
25-1864	$1\frac{1}{16}''-1''$	5"
25-1865	$1\frac{1}{16}''-\frac{3}{4}''$	6"

Hard

ITEM #	TAPER	LENGTH
25-1871	$\frac{9}{16}''-\frac{5}{16}''$	3"
25-1872	$\frac{3}{4}''-\frac{9}{16}''$	3"
25-1873	$\frac{7}{8}''-\frac{5}{8}''$	4"
25-1874	$1\frac{1}{16}''-1''$	5"



36. Felt Combination Buffs

- Medium density felt buffs for polishing the inside and outside of rings • One piece construction
- Performs well with all polishing compounds • Fit on tapered spindle polishers

ITEM #	TAPER	LENGTH	Ø X T
25-1881	$\frac{3}{4}''-\frac{9}{16}''$	3"	2" X $\frac{1}{2}''$
25-1882	$\frac{7}{8}''-\frac{5}{16}''$	4"	2" X $\frac{9}{16}''$



37. Felt Bangle Buffs

- High grade, medium density felt mounted on a hardwood core
- Use for polishing inside of bangles and bracelets
- Polishing can be controlled to the finest degree
- Fit on tapered spindle polishers

ITEM #	TAPER	LENGTH	GRADE
25-1885	2"- $1\frac{7}{8}''$	2"	REGULAR



38. 3M® Radial Bristle Discs

- Radial Bristle discs can be used for cleaning, finishing, blending and polishing
- Produce a high quality finish on gold, silver, platinum
- Reduces loading and smearing even at high speed
- No messy compounds or chemicals are required
- Long life with consistent performance
- Lubricate with water • Speed 10,000-max 20,000 rpm
- Sold by box - Priced each
- 6" discs are sold as 6 pcs stack with 1" bore plastic center

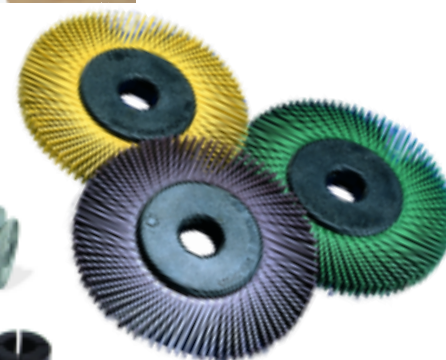
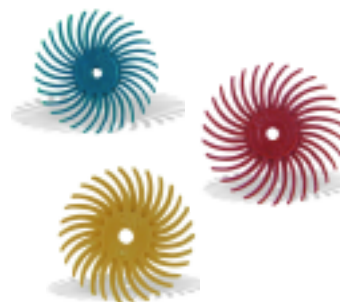
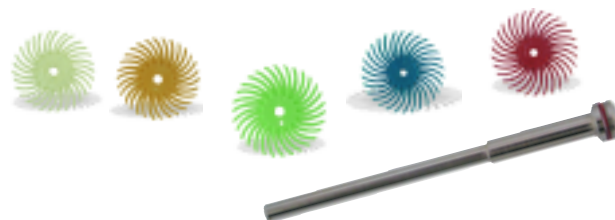
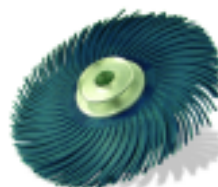

COLOR	GRIT	Bx/48 3/16" X 1/16"	Bx/48 3/4" X 1/16"
YELLOW	80	—	25-1721
WHITE	120	25-1712	—
RED	220	25-1713	25-1723
BLUE	400	25-1714	25-1724
PINK	PUMICE	25-1715	25-1725
PEACH	6 MIC.	25-1716	25-1726
LT. GREEN	1 MIC.	25-1717	25-1727

Use mandrel for 3/16", 3/4" and 1".
See page # 24

COLOR	GRIT	Bx/ 24 1" X 1/8"	Bx/ 10 2" X 3/8"
BROWN	36	25-1731	—
GREEN	50	25-1732	—
YELLOW	80	25-1733	25-1743
WHITE	120	25-1734	25-1744
RED	220	—	25-1745
BLUE	400	—	25-1746
PINK	PUMICE	—	25-1747
PEACH	6 MIC.	—	25-1748
LT. GREEN	1 MIC.	—	25-1749

COLOR	GRIT	Bx/ 10 3" X 3/8"	*Bx/ 6 6" X 1"
YELLOW	80	25-1751	25-1761
WHITE	120	25-1752	25-1762
RED	220	25-1753	25-1763
BLUE	400	25-1754	25-1764
PINK	PUMICE	25-1755	—
PEACH	6 MIC.	25-1756	25-1766
LT. GREEN	1 MIC.	25-1757	25-1767

* 6" discs are sold as 6 pcs stack with 1" bore plastic center.
Use a 25-1773 adapter to mount on taper spindle.

39. Adapter Mounts for Bristle Discs

All adapters mount on tapered spindles

ITEM #	DESCRIPTION
25-1771	PLASTIC ADAPTER FOR 2" & 3" Ø
25-1772	ALUMINUM ADAPTER FOR - 2" & 3" Ø
25-1773	DELTRIN ADAPTER HUB 1" Ø



40. 3M® Unitized Wheels

- Non-woven wheels in a unique construction
- Eliminates and resists loading
- Cushion like action when polishing precious metals, platinum and titanium

3M CODE	GRADE	1/2" X 1/4" X 1/16"	1/2" X 1/2" X 1/16"	3/4" X 1/8" X 1/16"
8ACRS	COARSE	25-1911	25-1915	25-1919
6AMED	MEDIUM	25-1912	25-1916	25-1920
4SFIN	FINE	25-1913	25-1917	25-1921
2VFN	X-FINE	25-1914	25-1918	

3M CODE	GRADE	1" X 1/4" X 1/8"	1 1/2" X 1/4" X 1/8"	1 1/2" X 1/2" X 1/4"	2" X 1/2" X 1/4"	3" X 1/2" X 1/4"
8ACRS	COARSE	25-1931	25-1935		25-1943	25-1947
6AMED	MEDIUM	25-1932	25-1936		25-1944	25-1948
4SFIN	FINE	25-1933	25-1937		25-1945	25-1949
2VFN	X-FINE	25-1934	25-1938	25-1942	25-1946	25-1950

3M CODE	GRADE	6" X 1" X 1"
2VFN	X-FINE	25-1904

New molded wheel technology for applying semi- and final finishes on platinum, gold, titanium, precious metal, clay, brass, cobalt and chrome.



41. 3M® FX Polishing Wheels - *May be run wet or dry*

- A comfortable wheel for final finishing of precious metals
- Excellent for semi and final finishes on platinum and titanium

ITEM #	GRIT	SIZE	ITEM #	GRIT	SIZE
25-1951	240	4" X 1" X 1"	25-1961	240	6" X 1" X 1"
25-1952	320	4" X 1" X 1"	25-1962	320	6" X 1" X 1"
25-1953	600	4" X 1" X 1"	25-1963	600	6" X 1" X 1"
25-1954	800	4" X 1" X 1"	25-1964	800	6" X 1" X 1"
25-1955	1500	4" X 1" X 1"	25-1965	1500	6" X 1" X 1"
25-1956	3000	4" X 1" X 1"	25-1966	3000	6" X 1" X 1"

- Use an adapter [25-1773](#) for mounting FX-Wheels on tapered spindels



ITEM #	DESCRIPTION
25-1773	DELRIN ADAPTER HUB 1" Ø

42. Wheel Flanges

- Select flanges according to wheel hole and motor shaft diameter pk/2

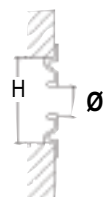

ITEM #	H	Ø
25-2121	1"	1/2"
25-2122	1"	5/8"
25-2123	1"	3/4"
25-2125	2"	1/2"
25-2126	2"	5/8"
25-2127	2"	3/4"
25-2128	2"	1"



43. 3M® Deburring Wheels

- The ideal wheel for sprue removal • May be used for blending and smoothing exterior surfaces
- Use with wheel flanges that have a 1" center hole • Max. speed 3,600 rpm

ITEM #	3M CODE	D X T X H	GRADE
25-1971	8AMED	6" X 1" X 1"	COARSE
25-1972	9SFIN	6" X 1" X 1"	MEDIUM
25-1973	7SFIN	6" X 1" X 1"	FINE



44. 3M® Cut & Polish Wheels

- Improves blending and polishing after initial deburring • Imparts a relative fineness to the smoothing
- Less aggressive action and does not load

ITEM #	3M CODE	D X T X H	GRADE
25-1977	5AFIN	1" X 1" X 3/16"	MEDIUM
25-1978	5AFIN	3" X 3/4" X 1/4"	MEDIUM
25-1979	5AFIN	6" X 1" X 1"	MEDIUM



45. 3M® General Purpose Wheels

- An all purpose wheel for general applications, sharpening, flash removal and deburring

ITEM #	3M CODE	D X T X H	GRADE
25-1981	7AFIN	3/4" X 1/4" X 1/16"	MEDIUM
25-1982	3AVFIN	3/4" X 1/4" X 1/16"	V-FINE
25-1984	5AFIN	3" X 3/4" X 1/4"	MEDIUM
25-1986	7AVFIN	4" X 1/4" X 1/8"	FINE
25-1987	7AVFIN	4" X 1/2" X 1/8"	FINE
25-1988	5AFIN	6" X 1" X 1"	MEDIUM



46. Artifex Elastic Bond Wheels

- Silicon carbide abrasive bonded on a non-clogging spongy base
- Resists snagging during fine deburring • Cushion effect eliminates gouging on precious metals

Size: 100 x 20 x 6 mm

ITEM #	GRIT	GRADE
25-1991	80	COARSE
25-1992	150	MEDIUM
25-1993	240	FINE

Size: 150 x 20 x 6 mm

ITEM #	GRIT	GRADE
25-1996	150	MEDIUM
25-1997	240	FINE



47. IkFlex Elastic Bond Wheels

- Silicon carbide abrasive in a non-clogging bond • Extra flexible for fine finishing of precious metals

Size: 100 x 20 x 6 mm

ITEM #	GRIT	GRADE
25-2011	80	COARSE
25-2012	150	MEDIUM
25-2013	240	FINE

Size: 150 x 20 x 6 mm

ITEM #	GRIT	GRADE
25-2016	80	COARSE
25-2017	150	MEDIUM
25-2018	240	FINE





48. Bergeon® Satin Finish Wheels- SiC

- Silicon carbide impregnated in an open pore synthetic fiber wheel
- Imparts a non glossy consistent finish
- Wheels are conforming and will not wear down high spots
- Recommended speed 3500-5000 rpm



ITEM #	DESCRIPTION	SIZE
25-1451	SATIN FINISH WHEEL M	4" X 3/4"
25-1452	SATIN FINISH WHEEL F	4" X 3/4"
25-1453	SATIN FINISH WHEEL VF	4" X 3/4"

50. Satin Finish Flap Wheels

- Excellent for contouring and satin finishes
- Use the extra fine grade for removing oxides and creating patina



ITEM #	DIMENSIONS	GRADE
25-1461	100 X 10 X 6 MM	FINE
25-1462	100 X 10 X 6 MM	V-FINE
25-1463	100 X 20 X 6 MM	FINE
25-1464	100 X 20 X 6 MM	V-FINE
25-1465	100 X 30 X 6 MM	FINE
25-1466	100 X 30 X 6 MM	V-FINE



49. Satiner-Compound for Satin Finish

Achieve a satin finish by buffing. Use this greaseless compound that combines a blend of fine abrasive in a water soluble bond. Apply across the face of a loose cloth buff. Allow the buff to spin for about 50 secs. until the satiner hardens. Polish the article for a satin finish.



ITEM #	DESCRIPTION
42-1121	SATINER 1 LB 220 GRIT



JAPANESE BUFFING AND POLISHING COMPOUNDS FOR PRECIOUS METAL

KOYO Polishing Compounds	Type of Buffs	Silver	Yellow Gold	White Gold	Platinum	Stainless Steel
ALOX CUT 1	A	•			•	
ALOX CUT 2	A	•	•	•		
GREEN ROUGE K2	B	•	•	•		•
GREEN ROUGE G-800	B				•	•
ALOX CUT 3	C	•	•	•	•	
GREEN ROUGE K1	C					•
ALOX 5	D		•	•	•	•
SUPER ALOX SILVER	D	•			•	
SUPER ALOX GOLD	D		•	•		

Cutting

Coloring

A: Tight weave 86/80 treated muslin buffs B: Dense weave 80/80 buffs C: Compressed felt ply buffs D: Unsewn loose weave muslin buffs

Characteristics of Buffs and Compounds

The right buff with a compatible polishing compound can increase production rates, reduce unit cost and generate a superior finish. Koyo polishing compounds can perform better with a low polishing pressure and high speed revolution. This extends the life of buffs so that a high efficiency of stability and quality can be obtained.

Peripheral Speed of Buffs

Chemically treated buffs exhibit a better performance than untreated buffs when they are used at lower speeds. Tightly woven buffs are recommended for cutting and pre-polishing. Medium to high speeds with loosely woven buffs are by far the best choice for final polishing. Speed 1700-2000m/min.

Polishing Pressure on Buffs

The correct balance of speed and pressure can dramatically increase the quality of the surface being polished. Exercise a lower polishing pressure to avoid excessive heat and drag lines in the final stages of finishing.



Burs

E



■ Acrylic Bur Stand	78	■ Jewelers Burs	70, 71, 72, 73
■ Black Top Bur Kits- German	77	■ Jumbo Bur Kit	74
■ Black Top Burs- German	77	■ Pearl Seat Bur Set	79
■ Bur Lube	80	■ Plastic Bur Stands	78
■ Bur Set	73	■ Rotating Bur Stand	78
■ Carbide Burs	78	■ Stone Setting Carbon Steel Bur Set	79
■ Carbide Florentine Burs	79	■ Tungsten Carbide Burs	80
■ Carbide Inside Ring Burs	79	■ Wax Burs	79
■ Carbide Rotary Bur-Japan	77	■ Wooden Bur Block	78
■ Diamond Burs	80	■ Wooden Bur Boxes	78
■ Florentine Cylinder Burs	79		
■ Gem Setting Bur with Gauge	80		
■ High Speed Jewelers Bur	75		
■ High Speed Jewelers Bur- Kit	76		



Jewelry – Two Books in One

by **Madeline Coles**

A unique instructional book with die-cut pages devoted to 23 outstanding projects. The top of each page illustrates each project and the bottom of each page discusses the appropriate techniques required to complete your work. Explanations of 20 techniques including cutting, sawing, drilling, filing, polishing, soldering, wire twisting, mitering, stone setting and more.

61-1020 (Hardcover-128 pages)

ikohe





1. Jewelers Burs- Hardened Tool Steel- Swiss

Burs made from the finest tool steel and hardened to exacting standards. All burs have $\frac{3}{32}$ " shanks.

Bx/6.





FIG-1 / 23
ROUND
 $\varnothing \frac{1}{10}$ MM

ISO	MM	ITEM #
003	0.30	26-1003
004	0.40	26-1004
005	0.50	26-1005
006	0.60	26-1006
007	0.70	26-1007
008	0.80	26-1008
009	0.90	26-1009
010	1.00	26-1010
011	1.10	26-1011
012	1.20	26-1012
013	1.30	26-1013
014	1.40	26-1014
015	1.50	26-1015
016	1.60	26-1016
017	1.70	26-1017
018	1.80	26-1018
019	1.90	26-1019
020	2.00	26-1020
021	2.10	26-1021
022	2.20	26-1022
023	2.30	26-1023
024	2.40	26-1024
025	2.50	26-1025
026	2.60	26-1026
027	2.70	26-1027
028	2.80	26-1028
029	2.90	26-1029
030	3.00	26-1030
031	3.10	26-1031
033	3.30	26-1033
035	3.50	26-1035
037	3.70	26-1037
040	4.00	26-1040
042	4.20	26-1042
045	4.50	26-1045
047	4.70	26-1047
050	5.00	26-1050
055	5.50	26-1055
060	6.00	26-1060
065	6.50	26-1065
070	7.00	26-1070
075	7.50	26-1075
080	8.00	26-1080
085	8.50	26-1085
090	9.00	26-1090
095	9.50	26-1095
100*	10.00	26-1100

GEMS





FIG-156C / HD
HART 90°
 $\varnothing \frac{1}{10}$ MM

ISO	MM	ITEM #
005	0.50	26-1105
006	0.60	26-1106
007	0.70	26-1107
008	0.80	26-1108
009	0.90	26-1109
010	1.00	26-1110
011	1.10	26-1111
012	1.20	26-1112
013	1.30	26-1113
014	1.40	26-1114
015	1.50	26-1115
016	1.60	26-1116
017	1.70	26-1117
018	1.80	26-1118
019	1.90	26-1119
020	2.00	26-1120
021	2.10	26-1121
022	2.20	26-1122
023	2.30	26-1123
024	2.40	26-1124
025	2.50	26-1125
026	2.60	26-1126
027	2.70	26-1127
028	2.80	26-1128
029	2.90	26-1129
030	3.00	26-1130
031	3.10	26-1131
033	3.30	26-1133
035	3.50	26-1135
037	3.70	26-1137
040	4.00	26-1140
042	4.20	26-1142
045	4.50	26-1145
047	4.70	26-1147
050	5.00	26-1150

GEMS





FIG-77B / S
CUP
 $\varnothing \frac{1}{10}$ MM

ISO	MM	ITEM #
008	0.80	26-1208
009	0.90	26-1209
010	1.00	26-1210
011	1.10	26-1211
012	1.20	26-1212
013	1.30	26-1213
014	1.40	26-1214
015	1.50	26-1215
016	1.60	26-1216
017	1.70	26-1217
018	1.80	26-1218
019	1.90	26-1219
020	2.00	26-1220
021	2.10	26-1221
022	2.20	26-1222
023	2.30	26-1223
025	2.50	26-1225
027	2.70	26-1227
029	2.90	26-1229
030	3.00	26-1230
035	3.50	26-1235
040	4.00	26-1240
045	4.50	26-1245
050	5.00	26-1250
055	5.50	26-1255
060	6.00	26-1260
065	6.50	26-1265
070	7.00	26-1270
075	7.50	26-1275
080	8.00	26-1280
085	8.50	26-1285
090	9.00	26-1290
095	9.50	26-1295
100*	10.00	26-1300

GEMS

* BX/4

* BX/4





FIG-231S/45
MTD. SAW
 $\varnothing \frac{1}{10}$ MM

ISO	MM	ITEM #
023	2.30	26-1153
029	2.90	26-1159
035	3.50	26-1165
040	4.00	26-1170

GEMS





FIG-256 / FK
KRAUSE
 $\varnothing \frac{1}{10}$ MM

ISO	MM	ITEM #
010	1.00	26-1180
012	1.20	26-1182

GEMS



**FIG-413 / Q(F)
SETTING**
Ø 1/10 MM

GEMS

ISO	MM	ITEM #
008	0.80	26-1308
009	0.90	26-1309
010	1.00	26-1310
012	1.20	26-1312
013	1.30	26-1313
014	1.40	26-1314
015	1.50	26-1315
016	1.60	26-1316
017	1.70	26-1317
018	1.80	26-1318
019	1.90	26-1319
020	2.00	26-1320
021	2.10	26-1321
022	2.20	26-1322
023	2.30	26-1323
024	2.40	26-1324
025	2.50	26-1325
027	2.70	26-1327
029	2.90	26-1329
030	3.00	26-1330
031	3.10	26-1331
033	3.30	26-1333
035	3.50	26-1335
037	3.70	26-1337
040	4.00	26-1340
042	4.20	26-1342
045	4.50	26-1345
047	4.70	26-1347
050	5.00	26-1350
060	6.00	26-1360
070	7.00	26-1370
080	8.00	26-1380



**FIG-161KE/HH
K/EDGE CUTTER**
Ø 1/10 MM

GEMS

ISO	MM	ITEM #
009	0.90	26-1409
010	1.00	26-1410
011	1.10	26-1411
012	1.20	26-1412
013	1.30	26-1413
014	1.40	26-1414
015	1.50	26-1415
016	1.60	26-1416
017	1.70	26-1417
018	1.80	26-1418
019	1.90	26-1419
020	2.00	26-1420
021	2.10	26-1421
022	2.20	26-1422
023	2.30	26-1423
024	2.40	26-1424
025	2.50	26-1425
027	2.70	26-1427
029	2.90	26-1429
030	3.00	26-1430
031	3.10	26-1431
033	3.30	26-1433
035	3.50	26-1435
037	3.70	26-1437
040	4.00	26-1440
042	4.20	26-1442
045	4.50	26-1445
047	4.70	26-1447
050	5.00	26-1450
060	6.00	26-1460
070	7.00	26-1470
080	8.00	26-1480
090	9.00	26-1490
100*	10.00	26-1500

* BX/4



**FIG-5 / NN(r)
CONE**
Ø 1/10 MM

GEMS

ISO	MM	ITEM #
008	0.80	26-1508
009	0.90	26-1509
010	1.00	26-1510
011	1.10	26-1511
012	1.20	26-1512
013	1.30	26-1513
014	1.40	26-1514
015	1.50	26-1515
016	1.60	26-1516
017	1.70	26-1517
018	1.80	26-1518
019	1.90	26-1519
020	2.00	26-1520
021	2.10	26-1521
022	2.20	26-1522
023	2.30	26-1523
025	2.50	26-1525
027	2.70	26-1527
029	2.90	26-1529
030	3.00	26-1530
031	3.10	26-1531
033	3.30	26-1533
035	3.50	26-1535
037	3.70	26-1537
040	4.00	26-1540
042	4.20	26-1542
045	4.50	26-1545
047	4.70	26-1547
050	5.00	26-1550



**SCUT
SUPER CUT**
Ø 1/10 MM

GEMS

ISO	MM	ITEM #
008	0.80	26-2731
009	0.90	26-2732
010	1.00	26-2733
011	1.10	26-2734
012	1.20	26-2735
013	1.30	26-2736
014	1.40	26-2737
015	1.50	26-2738
016	1.60	26-2739
017	1.70	26-2740
018	1.80	26-2741
019	1.90	26-2742
020	2.00	26-2743
021	2.10	26-2744
022	2.20	26-2745
023	2.30	26-2746



**FIG 15 / 29
CYL. TWIST**
Ø 1/10 MM

GEMS

ISO	MM	ITEM #
007	0.70	26-1607
008	0.80	26-1608
009	0.90	26-1609
010	1.00	26-1610
012	1.20	26-1612
014	1.40	26-1614
016	1.60	26-1616
018	1.80	26-1618
021	2.10	26-1621
023	2.30	26-1623
025	2.50	26-1625
027	2.70	26-1627



**FIG-2 / 25
WHEEL**
Ø 1/10 MM

GEMS

ISO	MM	ITEM #
006	0.60	26-1706
007	0.70	26-1707
008	0.80	26-1708
009	0.90	26-1709
010	1.00	26-1710
011	1.10	26-1711
012	1.20	26-1712
013	1.30	26-1713
014	1.40	26-1714
015	1.50	26-1715
016	1.60	26-1716
018	1.80	26-1718
021	2.10	26-1721
023	2.30	26-1723
025	2.50	26-1725
027	2.70	26-1727
029	2.90	26-1729



Jewelers Burs- Hardened Tool Steel- Swiss

Bx/6.



ISO	MM	ITEM #
005	0.50	26-1805
006	0.60	26-1806
007	0.70	26-1807
008	0.80	26-1808
009	0.90	26-1809
010	1.00	26-1810
011	1.10	26-1811
012	1.20	26-1812
013	1.30	26-1813
014	1.40	26-1814
015	1.50	26-1815
016	1.60	26-1816
017	1.70	26-1817
018	1.80	26-1818
019	1.90	26-1819
020	2.00	26-1820
021	2.10	26-1821
022	2.20	26-1822
023	2.30	26-1823
025	2.50	26-1825
027	2.70	26-1827
029	2.90	26-1829
031	3.10	26-1831
033	3.30	26-1833
035	3.50	26-1835
037	3.70	26-1837

GEMS



ISO	MM	ITEM #
006	0.60	26-1906
007	0.70	26-1907
008	0.80	26-1908
009	0.90	26-1909
010	1.00	26-1910
012	1.20	26-1912
014	1.40	26-1914
015	1.50	26-1915
016	1.60	26-1916
018	1.80	26-1918
021	2.10	26-1921
023	2.30	26-1923
025	2.50	26-1925
027	2.70	26-1927
029	2.90	26-1929
031	3.10	26-1931
033	3.30	26-1933
035	3.50	26-1935
037	3.70	26-1937
040	4.00	26-1940
042	4.20	26-1942
045	4.50	26-1945
047	4.70	26-1947
050	5.00	26-1950

GEMS



ISO	MM	ITEM #
007	0.70	26-2007
008	0.80	26-2008
009	0.90	26-2009
010	1.00	26-2010
012	1.20	26-2012
014	1.40	26-2014
016	1.60	26-2016
018	1.80	26-2018
021	2.10	26-2021
023	2.30	26-2023
025	2.50	26-2025
027	2.70	26-2027

GEMS



ISO	MM	ITEM #
007	0.70	26-2107
008	0.80	26-2108
009	0.90	26-2109
010	1.00	26-2110
012	1.20	26-2112
014	1.40	26-2114
016	1.60	26-2116
018	1.80	26-2118
021	2.10	26-2121
023	2.30	26-2123
025	2.50	26-2125
027	2.70	26-2127

GEMS



ISO	MM	ITEM #
006	0.60	26-2206
007	0.70	26-2207
008	0.80	26-2208
009	0.90	26-2209
010	1.00	26-2210
012	1.20	26-2212
014	1.40	26-2214
016	1.60	26-2216
018	1.80	26-2218
021	2.10	26-2221
023	2.30	26-2223
025	2.50	26-2225
027	2.70	26-2227
029	2.90	26-2229

GEMS



ISO	MM	ITEM #
009	0.90	26-2309
010	1.00	26-2310
012	1.20	26-2312
014	1.40	26-2314
016	1.60	26-2316
018	1.80	26-2318
021	2.10	26-2321
023	2.30	26-2323
025	2.50	26-2325

GEMS



ISO	MM	ITEM #
006	0.60	26-2406
007	0.70	26-2407
008	0.80	26-2408
009	0.90	26-2409
010	1.00	26-2410
011	1.10	26-2411
012	1.20	26-2412
013	1.30	26-2413
014	1.40	26-2414
015	1.50	26-2415
016	1.60	26-2416
018	1.80	26-2418
021	2.10	26-2421
023	2.30	26-2423
025	2.50	26-2425

GEMS





This icon is intended to draw your attention to specific safety practices when working with tools and equipment.



Jewelers Burs...Swiss

Bx/6.

			28
			CYL. ROUND
			Ø 1/10 MM
			
ISO	MM	ITEM #	
007	0.70	26-2507	
008	0.80	26-2508	
009	0.90	26-2509	
010	1.00	26-2510	
012	1.20	26-2512	
014	1.40	26-2514	
016	1.60	26-2516	
018	1.80	26-2518	
021	2.10	26-2521	
023	2.30	26-2523	



GEMS Bur Sets- Alloy Tool Steel: Burs with special points and styles in a range of smaller diameters. Carefully heat treated to maximize sharpness over extended use.

2. Setting Bur

Set of 12 burs in a plastic pouch. Shank size 3/32". Sizes are 010, 012, 015, 016, 020, 022, 033, 035, 037, 040, 045, 050.

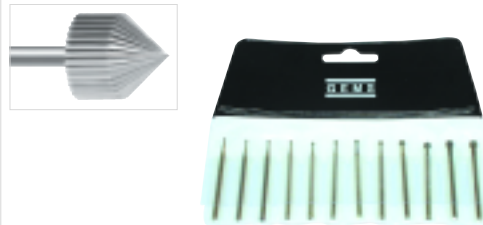



ITEM #	DESCRIPTION
26-2755	SETTING BUR 12PCS SET

3. Round Bur

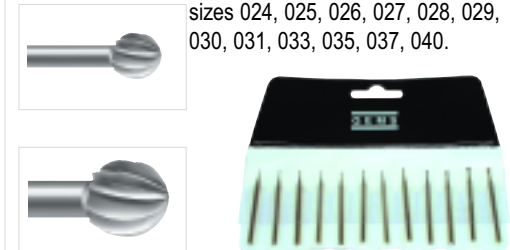
Set of 12 burs in a plastic pouch. Shank size 3/32". Small set consists of sizes 006, 007, 009, 012, 013, 014, 015, 018, 019, 021, 022, 023. Large set consists of sizes 024, 025, 026, 027, 028, 029, 030, 031, 033, 035, 037, 040.



ITEM #	DESCRIPTION
26-2751	ROUND SMALL 12PCS SET
26-2752	ROUND LARGE 12PCS SET

			36
			CYL. RND. C.C.
			Ø 1/10 MM
			
ISO	MM	ITEM #	
007	0.70	26-2607	
008	0.80	26-2608	
009	0.90	26-2609	
010	1.00	26-2610	
012	1.20	26-2612	
014	1.40	26-2614	
016	1.60	26-2616	
018	1.80	26-2618	
021	2.10	26-2621	
023	2.30	26-2623	
025	2.50	26-2625	
027	2.70	26-2627	
029	2.90	26-2629	



4. Cone Bur

Set of 12 burs in a plastic pouch. Shank size 3/32". Sizes are 008, 009, 010, 012, 013, 016, 018, 019, 020, 021, 022, 023.

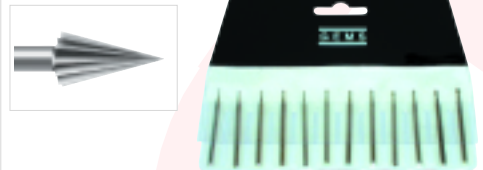

ITEM #	DESCRIPTION
26-2754	CONE BUR 12PCS SET

5. Cup Bur

Set of 12 burs in a plastic pouch. Shank size 3/32". Sizes are 009, 011, 012, 013, 015, 016, 017, 018, 020, 023, 027, 030.

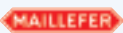

ITEM #	DESCRIPTION
26-2756	CUP BUR 12PCS SET

			26
			CYLINDER SQ.
			Ø 1/10 MM
			
ISO	MM	ITEM #	
007	0.70	26-2707	
008	0.80	26-2708	
009	0.90	26-2709	
010	1.00	26-2710	
012	1.20	26-2712	
014	1.40	26-2714	
016	1.60	26-2716	
018	1.80	26-2718	
021	2.10	26-2721	
023	2.30	26-2723	
025	2.50	26-2725	
027	2.70	26-2727	



6. Hart Bur 90°

Set of 12 burs in a plastic pouch. Shank size 3/32". Sizes are 009, 010, 012, 013, 014, 015, 018, 021, 023, 025, 030, 031.



ITEM #	DESCRIPTION
26-2753	HART BUR 90° 12PCS SET

7. Cone SQ/CC

Set of 12 burs in a plastic pouch. Shank size 3/32". Sizes are 007, 008, 009, 011, 012, 013, 014, 015, 016, 018, 021, 023.

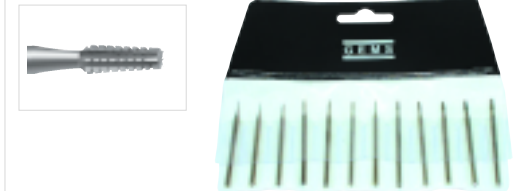

ITEM #	DESCRIPTION
26-2757	CONE SQ/CC 12PCS SET



Jumbo Bur Kits- Swiss

If you're focused on a full range of burs in different shapes, make these your choice. Made from graded tool steel, manufactured to close tolerances and precisely tempered, these burs have a keen cutting edge. Experience a fast smooth chip flow leading to superior surface finishes.



8. Bur Kit - Round

Set of round burs. Organized on a plastic stand with a clear cover.



Shank $\frac{3}{32}$ "

ITEM #	DESCRIPTION
26-2761	ROUND -20 PCS (2.5 - 9.6MM)

9. Bur Kit - Bud

Set of bud burs. Organized on a plastic stand with a clear cover.



Shank $\frac{3}{32}$ "

ITEM #	DESCRIPTION
26-2762	BUD -20 PCS (0.7 - 4.7MM)

10. Bur Kit - Wheel

Set of wheel burs. Organized on a plastic stand with a clear cover.

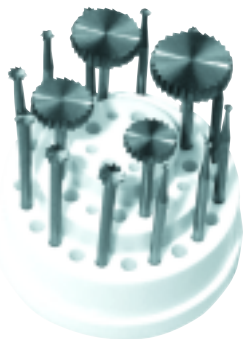

Shank $\frac{3}{32}$ "

ITEM #	DESCRIPTION
26-2763	WHEEL -16 PCS (1.4 - 16.0MM)

11. Bur Kit - Hart 90°

Set of hart burs. Organized on a plastic stand with a clear cover.



Shank $\frac{3}{32}$ "

ITEM #	DESCRIPTION
26-2764	HART -19 PCS (0.9 - 4.6MM)

12. Bur Kit Assorted

Set of bur shapes: round, bud, hart, setting, cone, finishing, flame, cup, oval and cylinder.



Organized on a plastic stand with a clear cover.

Shank $\frac{3}{32}$ "

ITEM #	DESCRIPTION
26-2765	ASSORTED BURS 24 PCS (1.0 - 7.2MM)

13. Bur Set - Finishing

Set of finishing burs in shapes- round, cone, oval, flame, pearl, inlay and bud. Organized on a plastic stand with a clear cover.



Shank $\frac{3}{32}$ "

ITEM #	DESCRIPTION
26-2767	FINISHING- 12 PCS

14. Bur Kit - Deluxe Carving

A speciality set of shapes for carving metal, wood or wax. Organized on a plastic stand with a clear cover.



Shank $\frac{1}{8}$ "

ITEM #	DESCRIPTION
26-2768	CARVING KIT 12PCS

Wax Bur Set-1445



For details see page# 79



ITEM #	DESCRIPTION
26-5467	6 PCS 2 HELIX, 4 RND



15. Jewelers Burs- High Speed Steel -USA

Experience the superior cutting performance of burs made from high density, tough cobalt alloy steel. Significant reduction in cost due to long lasting edge sharpness. Operate these burs at higher speeds to generate smoother surface finishes. Shank size $\frac{3}{32}$ ". **Sold each.**

ROUND			BEARING 90°			SETTING			HART 45°		
#	MM	ITEM #	ITEM #	ITEM #	ITEM #	#	MM	ITEM #			
1	0.90	26-3101	26-3201	26-3301							
2	1.10	26-3102	26-3202	26-3302		2	1.10	26-3402			
3	1.30	26-3103	26-3203	26-3303		3	1.30	26-3403			
4	1.50	26-3104	26-3204	26-3304		4	1.50	26-3404			
5	1.70	26-3105	26-3205	26-3305		5	1.70	26-3405			
6	1.90	26-3106	26-3206	26-3306		6	1.90	26-3406			
7	2.10	26-3107	26-3207	26-3307		7	2.10	26-3407			
8	2.30	26-3108	26-3208	26-3308		8	2.30	26-3408			
9	2.50	26-3109	26-3209	26-3309		9	2.50	26-3409			
10	2.70	26-3110	26-3210	26-3310		10	2.70	26-3410			
11	2.90	26-3111	26-3211	26-3311		11	2.90	26-3411			
12	3.10	26-3112	26-3212	26-3312		12	3.10	26-3412			
13	3.30	26-3113	26-3213	26-3313		13	3.30	26-3413			
14	3.50	26-3114	26-3214	26-3314		14	3.50	26-3414			
15	3.80	26-3115	26-3215	26-3315		15	3.80	26-3415			
16	4.00	26-3116	26-3216	26-3316		16	4.00	26-3416			
17	4.30	26-3117	26-3217	26-3317		17	4.30	26-3417			
18	4.50	26-3118	26-3218	26-3318		18	4.50	26-3418			
19	4.70	26-3119	26-3219	26-3319		19	4.70	26-3419			
20	5.00	26-3120	26-3220	26-3320		20	5.00	26-3420			
22	5.20	26-3122	26-3222	26-3322		22	5.20	26-3422			
23	5.40	26-3123	26-3223	26-3323							
24	5.60	26-3124	26-3224	26-3324		24	5.60	26-3424			
25	5.90	26-3125	26-3225	26-3325							
26	6.30	26-3126	26-3226	26-3326		26	6.30	26-3426			
27	6.70	26-3127	26-3227	26-3327							
28	7.20	26-3128	26-3228	26-3328		28	7.20	26-3428			
29	7.60	26-3129	26-3229	26-3329							
30	8.00	26-3130	26-3230	26-3330		30	8.00	26-3430			
31	8.90	26-3131	26-3231	26-3331							
32	9.60	26-3132	26-3232	26-3332							
33	10.40	26-3133	26-3233	26-3333							
34	11.10	26-3134	26-3234	26-3334		34	11.10	26-3434			

Bur Size Comparison Chart

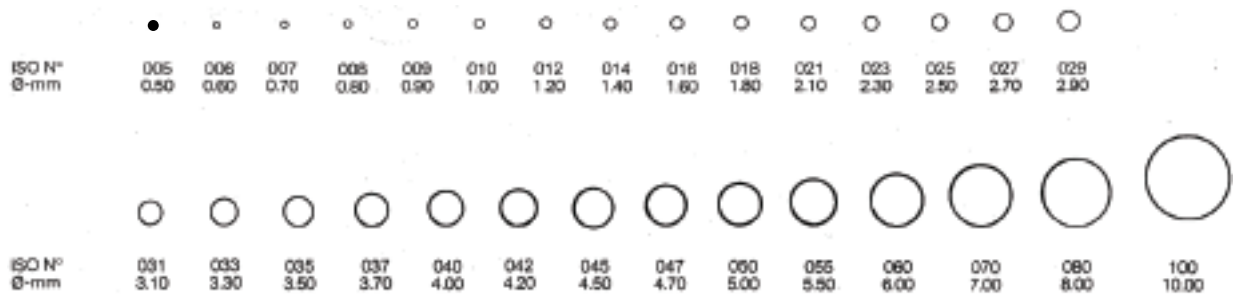



Bur Kit- High Speed Steel- USA

Kit contains the most popular sizes in specific shapes. All have $\frac{3}{32}$ " shanks which will fit most flexible shaft handpieces.

- Select Burs according to the shapes, material and shank diameter.
- Bur diameters are either in ISO No. or mm. The reference chart specifies the nominal diameters of the bur.
- High Speed Steel burs last longer than tungsten vanadium steel. Carbide burs have the longest life.
- Small diameter burs are generally run at higher speeds than large diameter burs.
- Use of a lubricant reduces friction and extends bur life.

16. Hart 90° - Extra Fine Cut

Set of 33 burs. Shank size $\frac{3}{32}$ ". All organized in a polished wooden box.

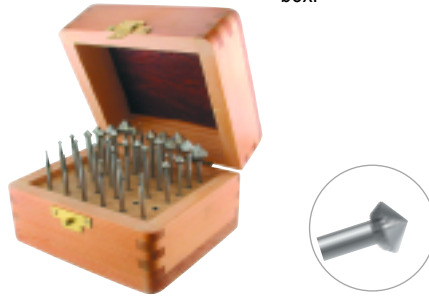

ITEM #	DESCRIPTION
26-3451	#1-34 -33 PCS (EXCEPT #21)

17. Hart 45° - Extra Fine Cut

Set of 24 burs. Shank size $\frac{3}{32}$ ". All organized in a polished wooden box.



ITEM #	DESCRIPTION
26-3452	#2-20 -24 PCS (EVEN SIZES #21-30)

18. Setting - Extra Fine Cut

Set of 33 burs. Shank size $\frac{3}{32}$ ". All organized in a polished wooden box.



ITEM #	DESCRIPTION
26-3453	#1-34 -33 PCS (EXCEPT #21)

19. Flame - Extra Fine Cut

Set of 14 burs. Shank size $\frac{3}{32}$ ". All organized in a polished wooden box.



ITEM #	DESCRIPTION
26-3454	EVEN SIZES-14 PCS #2-26 & #30

20. Round - Extra Fine Cut

Set of 33 burs. Shank size $\frac{3}{32}$ ". All organized in a polished wooden box.



ITEM #	DESCRIPTION
26-3455	#1-34 -33 PCS (EXCEPT #21)

21. Bud - Extra Fine Cut

Set of 23 burs. Shank size $\frac{3}{32}$ ". All organized in a polished wooden box.

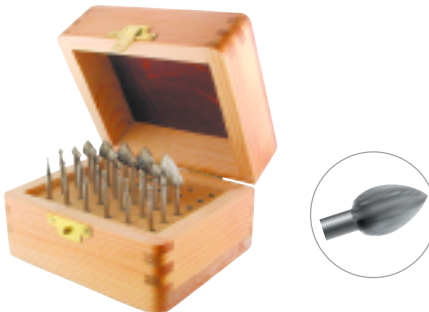

ITEM #	DESCRIPTION
26-3456	#2-34 -23 PCS

22. Cone - Extra Fine Cut

Set of 23 burs. Shank size $\frac{3}{32}$ ". All organized in a polished wooden box.



ITEM #	DESCRIPTION
26-3457	#2-34 -23 PCS

23. Bur Setting Gauges

Precision Swiss made, plate type gauge to check bur diameters in ISO sizes. Easy to read numbers on a silver background.



ITEM #	DESCRIPTION
26-3006	BUR GAUGE-(005-023)



24. Black Top Burs- German

Made of tungsten vanadium alloy steel. These burs provide extra long life due to superior cutting tooth geometry. Manufactured to close tolerances and precise forms, they are ideal for carving and finishing. Shank size $\frac{3}{32}$ ".



Bx/100		CUP
ISO	MM	ITEM #
010	1.00	26-4010
012	1.20	26-4012
014	1.40	26-4014
015	1.50	26-4015
016	1.60	26-4016
018	1.80	26-4018
021	2.10	26-4021
023	2.30	26-4023



Sold each.

		SETTING
ISO	MM	ITEM #
010	1.00	26-4110
0125	1.25	26-4112
015	1.50	26-4115
0175	1.75	26-4117
020	2.00	26-4120
0225	2.25	26-4122
025	2.50	26-4125
0275	2.75	26-4127
030	3.00	26-4130
0325	3.25	26-4132
035	3.50	26-4135
0375	3.75	26-4137
040	4.00	26-4140
0425	4.25	26-4142
045	4.50	26-4145
0475	4.75	26-4147
050	5.00	26-4150
0525	5.25	26-4152
055	5.50	26-4155
0575	5.75	26-4157
060	6.00	26-4160
0625	6.25	26-4162
065	6.65	26-4165
0675	6.75	26-4167
070	7.00	26-4170
0725	7.25	26-4172
075	7.50	26-4175
0775	7.75	26-4177
080	8.00	26-4180

26-3001



GEMS Bur Lube

Increases life and cutting efficiency of your burs. See Page # 80

25. Carbide Rotary Bur-Japan

This tool removes fire scale, porosity, pits and scratch marks. Burnishers have mirrored flats for coarse, medium and fine finish. Shank size $\frac{3}{32}$ ". Max. speed 10,000 to 15,000 rpm.



ITEM #	DESCRIPTION	
26-2496	12 SIDE 5 Ø X 13MM	COARSE
26-2497	18 SIDE 5 Ø X 13MM	MEDIUM
26-2498	36 SIDE 5 Ø X 13MM	FINE

Black Top Bur Kits - German

Made of tungsten vanadium alloy steel. These burs provide extra long life due to superior cutting tooth geometry. Manufactured to close tolerances and precise forms, they are ideal for carving and finishing. Shank size $\frac{3}{32}$ ".

26. Black Top Bur-Round

Set of 17 burs in increments of 0.5 mm, from 2 to 10 mm in a polished wooden box. Shank size $\frac{3}{32}$ ".



ITEM #	DESCRIPTION
26-4191	SET OF 17

27. Black Top Bur-Setting

Set of 29 burs in increments of 0.5 mm, from 1 to 8 mm in a polished wooden box. Shank size $\frac{3}{32}$ ".



ITEM #	DESCRIPTION
26-4192	SET OF 29

28. Black Top Bur-Cup

Set of 17 burs in increments of 0.25 mm, from 1 to 8 mm in a polished wooden box. Shank size $\frac{3}{32}$ ".



ITEM #	DESCRIPTION
26-4193	SET OF 17

29. Black Top Bur - Assorted

Set of 30 burs in increments of 1 mm, from 2 to 7 mm in a polished wooden box. Shank size $\frac{3}{32}$ ". Contents- 6 each of round, setting, cone, cup and cylinder shapes.



ITEM #	DESCRIPTION
26-4194	SET OF 30



30. Carbide Burs

Designed to cut with confidence, these carbide burs yield high productivity. Exceptional durability and wear resistance enables you to cut and finish at the same time. Burs have $\frac{3}{32}$ " shank size for use on friction grip high speed flexshaft handpieces. Speed 30,000- 35,000 rpm. **Bx/6.**



ROUND/123		
ISO	MM	ITEM #
002	0.20	26-5002
003	0.30	26-5003
004	0.40	26-5004
005	0.50	26-5005
006	0.60	26-5006
007	0.70	26-5007
008	0.80	26-5008
009	0.90	26-5009
010	1.00	26-5010
011	1.10	26-5011
012	1.20	26-5012
013	1.30	26-5013
014	1.40	26-5014
015	1.50	26-5015
016	1.60	26-5016
017	1.70	26-5017
018	1.80	26-5018
019	1.90	26-5019
021	2.10	26-5021
023	2.30	26-5023
027	2.70	26-5027



INV.CONE / 124		
ISO	MM	ITEM #
006	0.60	26-5106
007	0.70	26-5107
008	0.80	26-5108
009	0.90	26-5109
010	1.00	26-5110
012	1.20	26-5112
014	1.40	26-5114
016	1.60	26-5116
018	1.80	26-5118



CYL. SQ.CROSS CUT #137		
ISO	MM	ITEM #
008	0.80	26-5208
009	0.90	26-5209
010	1.10	26-5210
012	1.20	26-5212
014	1.40	26-5214
016	1.60	26-5216
018	1.80	26-5218



WHEEL CUT #125		
ISO	MM	ITEM #
012	1.20	26-5412



CONE CROSS CUT #138		
ISO	MM	ITEM #
008	0.80	26-5308
009	0.90	26-5309
010	1.00	26-5310
012	1.20	26-5312
014	1.40	26-5314
016	1.60	26-5316
018	1.80	26-5318
021	2.10	26-5321
023	2.30	26-5323

USE OF CARBIDE BURS

- Ensure that the handpiece collet runs true without any axial play
- Insert the bur shank as far as possible in the collet
- Avoid levering with the bur as this may cause breakage
- To produce optimum results, burs must be run at their recommended speeds
- Excessive pressure must be avoided to prevent heat build up
- Eye protection is recommended

31. Rotating Bur Stand

Tiered, heavy duty plastic stand. Accommodates 150 burs $\frac{3}{32}$ " shank. The revolving design makes it easy to choose the right bur.



ITEM #	DESCRIPTION
26-2391	BUR STAND FOUR TIERS

32. Plastic Bur Stands

Rectangular plastic stand to hold $\frac{3}{32}$ " shank size burs. Keeps burs organized and protects the cutting edges from damage.

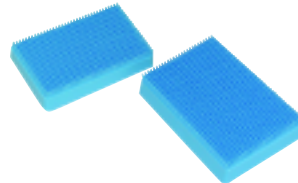

ITEM #	DESCRIPTION
26-2393	LARGE- 5 $\frac{1}{4}$ " X 3 $\frac{1}{2}$ "
26-2392	SMALL- 4 $\frac{3}{4}$ " X 3"

33. Acrylic Bur Stand

Clear acrylic stand with 36 holes to store $\frac{3}{32}$ " shank size burs.

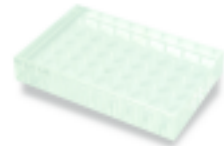

ITEM #	DIMENSIONS
26-2394	4 $\frac{1}{2}$ " X 3" X $\frac{3}{4}$ "

34. Wooden Bur Boxes

Hardwood box with hinged cover to store burs with $\frac{3}{32}$ " shank. Keeps burs organized and protected.

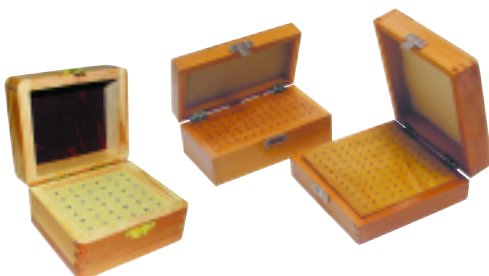

ITEM #	DESCRIPTION
26-2396	BUR BOX- 36 HOLES
26-2397	BUR BOX- 72 HOLES
26-2398	BUR BOX- 100 HOLES

35. Wooden Bur Block

Slanted, hardwood block stand, with non-slip rubber grip base. Organizes burs, drills, files, and brushes of either $\frac{3}{32}$ " or $\frac{1}{8}$ " shanks.

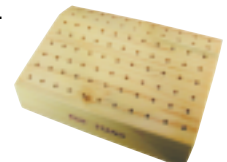

ITEM #	DESCRIPTION
26-2399	BUR BLOCK-88 HOLES



36. Florentine Cylinder Burs

Made from high quality tungsten carbide, these tools are extremely efficient for fine chip removal. Available in different diameters and grades. Shank size $\frac{3}{32}$ ".



ITEM #	HEAD Ø	GRADE
26-5451	7MM	FINE
26-5452	7MM	COARSE
26-5453	9.5MM	FINE
26-5454	9.5MM	COARSE

37. Wax Burs-1445

These are special burs for carving wax models. Widely spaced flutes provide smooth cutting and will not clog like standard burs. Available individually or in a set of 6 shapes. Shank size $\frac{3}{32}$ ".



ITEM #	DESCRIPTION
26-5461	016-HELIX
26-5462	018-HELIX
26-5463	023-HELIX
26-5464	023-ROUND
26-5465	030-ROUND
26-5466	050-ROUND
26-5467	6 PCS- (2 HELIX, 4 ROUND)

38. Stone Setting Carbon Steel Bur Set

An indispensable bur set for cutting precise stone seats. Made of carbon steel. Available in different sets, neatly organized on an acrylic stand. Shank size $\frac{3}{32}$ ".



ITEM #	DESCRIPTION
26-5483	BUR SET OF 22 PCS
26-5484	BUR SET OF 30 PCS

39. Carbide Florentine Burs

Carbide burs easily surpass ordinary steel tools and are the logical choice to produce the most brilliant finish by any rotary tool. Improved penetration allows quick clean cutting at high speeds. Shank size $\frac{1}{8}$ ".



ITEM #	Ø X H	SHAPE
26-5457	$\frac{1}{8}$ " X $\frac{1}{2}$ "	CYLINDER
26-5458	$\frac{1}{8}$ " X $\frac{1}{2}$ "	POINT
26-5459	$\frac{5}{32}$ " X $\frac{5}{32}$ "	BARREL

40. Carbide Inside Ring Burs

Long lasting and wear resistant carbide with fine teeth, designed for high speed smoothing and finishing the inside of rings. Different finishes are possible from coarse to extra fine.



ITEM #	Ø X H X SH	GRADE
26-5471	$\frac{1}{4}$ " X $\frac{1}{2}$ " X $\frac{3}{32}$ "	COARSE
26-5472	$\frac{1}{4}$ " X $\frac{1}{2}$ " X $\frac{3}{32}$ "	FINE
26-5473	$\frac{1}{4}$ " X $\frac{1}{2}$ " X $\frac{3}{32}$ "	X-FINE
26-5475	$\frac{1}{4}$ " X 1" X $\frac{3}{32}$ "	COARSE
26-5476	$\frac{1}{4}$ " X 1" X $\frac{3}{32}$ "	FINE
26-5477	$\frac{1}{2}$ " X 1" X $\frac{1}{8}$ "	FINE
26-5481	$\frac{3}{8}$ " X $\frac{3}{4}$ " X $\frac{1}{8}$ "	STD
26-5482	$\frac{3}{8}$ " X $\frac{3}{4}$ " X $\frac{1}{8}$ "	FINE

41. Pearl Seat Bur Set

Accurately calibrated sizes, specifically designed for cutting the seat and simultaneously forming a peg for securing the pearl. Made in high speed steel. Shank size $\frac{3}{32}$ ". Set contains 0.20, 0.25, 0.30, 0.35, 0.40, 0.45, 0.50, 0.55, 0.60, 0.65, 0.70, 0.75, 0.80, 0.90, 1.00mm sizes.



ITEM #	DESCRIPTION
25-5486	BUR SET OF 15 PCS



42. Tungsten Carbide Burs

Over all length (h) 44.5mm
Shank size $\frac{3}{32}$ "

Standard

High quality tungsten carbide with fine teeth. Designed to operate at high speeds. Cross cut cutting edges for fast stock removal. Recommended operating speed 15,000-20,000 rpm.

Volcano

Micro-Grain Carbide

A new generation of tungsten carbide cutters with a micro-fine structure. Extremely silent and vibration free performance. Smooth cutting capability facilitates easy removal of shavings. Recommended operating speed 15,000- 20,000 rpm.



FIG.



257



72



296

ITEM #

26-5514

26-5516

26-5518

CUTTING LENGTH (L)

17MM

12.5MM

12.5MM

TYPE

C/CUT STANDARD

C/CUT STANDARD

PLAIN STANDARD



FIG.

251



138

ITEM #

26-5521

26-5522

CUTTING LENGTH (L)

13.9MM

8MM

TYPE

C/CUT STANDARD

C/CUT STANDARD



43. Diamond Burs

Diamond coated burs, in a fine grit for countouring work. Ultra smooth surfaces reduce finishing time. Use water as a lubricant. Recommended operating speed 15,000- 20,000 rpm. Overall length (h) 44.5mm
Shank size $\frac{3}{32}$ "



FIG.

840

842KR

848L

850

ITEM #

26-5551

26-5552

25-5553

26-5554

CUTTING LENGTH (L)

7MM

15MM

15MM

10MM

SHAPE

CYLINDER

RND EDGE CYL.

LONG TAPERED

RND END TAPERED

44. Bur Lube

A carefully formulated compound that provides optimum balance of cooling and lubrication. Reduces friction and heat build up, thereby extending tool life. Essential when drilling, cutting or grinding.



ITEM #

DESCRIPTION

26-3001

BUR LUBE 2 OZ

26-3002

BUR LUBE LIQUID 4 OZ

26-3003

BUR LUBE PASTE 4 OZ

45. Gem Setting Bur with Gauge

Set stones like a master jeweler with this indispensable new innovation. Achieve precision without the guess work. Cut channels to a perfect size to match the corresponding gauge. Drop the stone into seat and close the prongs or bezels. Shank size $\frac{3}{32}$ ".

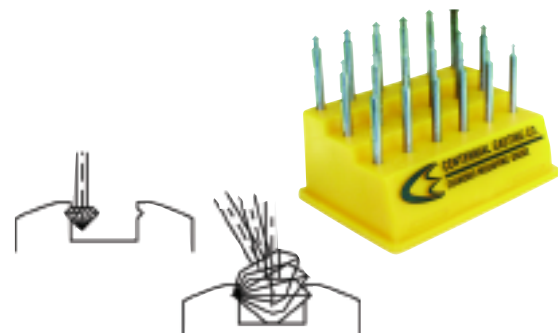

ITEM #

DESCRIPTION

26-3008

18 PCS. (1.0-5.0MM)



CASTING



■ Alloys	89	■ Melting Dishes-Platinum	99	■ Satin Cast Investment	89
■ Aluminum Mold Frames	88	■ Mold Frames	88	■ Soft Grip Knife	87
■ Base Mate®	93	■ Mold Cream	87	■ Sprue Bases & Holders	93
■ Castaldo® Mold Rubber	84, 85	■ Mold Cutting Blades & K/Handles	88	■ Sprue R/Former/Sprue Mandrel	87
■ Centrifugal Machine-Long Arm	95	■ Mold Frame Plates	86	■ St. Louis V/C Investment Mixers	85
■ Crucible Tongs	92	■ Mold Lock Formers	88	■ Stirring Rods	98
■ Crucible with Handle	92	■ Mold Mate	87	■ Vulcanizers	83
■ Crucibles & Melting Dish	99	■ Mold Release Spray	87	■ Vacuum Casting Machines	94, 95
■ Dial Thermometer	90	■ Molding Rubber	84, 85, 87	■ Wax Injectors	82
■ Electro-Melt Furnace	98	■ Moldmatic® Ready Made Molds	86		
■ Ferris® See-Thru Mold Frames	86	■ Neycraft® Centrifugal C/Machine	95		
■ Flask - Regular	91	■ Non-Asbestos Paper Rolls	91		
■ Flask Extender & Sleeves	91	■ Perforated & Regular Flasks	94		
■ Flask Tongs	92	■ Platinum Casting Machine	84		
■ Furnaces- Fiber / Burnouts	92	■ Professional J/Molding Rubber	87		
■ Gaskets	96	■ Resin Release	87		
■ Heat Resistant Gloves	96	■ Salamander Graphite Crucibles	99		
■ High Pressure Blaster Cabinet	91	■ Satellite Furnaces	97		
■ Hydro Air Wash Gun	90				
■ IKOHE LMR- Liquid Mold Rubber	87				
■ Ingot & Graphite Molds	100				
■ Investment Mixer	94				
■ Inva-Cast	90				
■ Investment Mixing Bowls- Rubber	90				
■ Investment Scale	90				
■ Investment Scoop / spatula	97				
■ Italian Saturn® Melter	87				
■ Jewelry Mold Release Spray	98				
■ Kerr® Graphite Crucibles	86				
■ LiqaCast® Liquid Mold Rubber	86				
■ LiqaGlass®	86				
■ Masking Tapes	92				

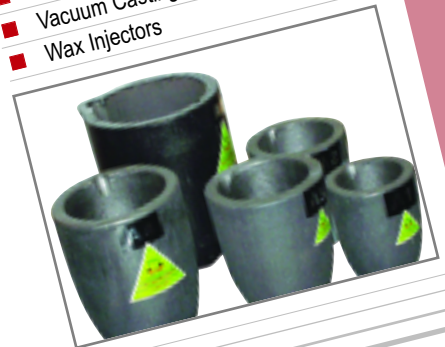



1. Wax Injectors - Italy

These manual wax injectors have an aluminum melting chamber for uniform diffusion of heat and an optimum fusion of wax. Equipped with a main heating chamber and an auxiliary one on the ejection conduit. Includes three different nozzles-conical, cylindrical and hemi-spherical to suit different matrices.

- Accurate electronic control with thermostat for precise wax temperature
- Pressure gauge with safety valve for discharge of air
- Superior heating band guarantees uniform temperature
- Exclusive air tight locking system to prevent loss of pressure

MODEL	1500M	2500M
CAPACITY	1500 CC -1.6 QT	2500 CC- 2.6 QT
HEATING POWER	160 W	320 W
DIMENSIONS	160 X 160 X 520 MM	194 X 194 X 520 MM

ITEM #	SPECIFICATION	CAPACITY
27-1021	110V / 60HZ	1500M
27-1022	220V / 50HZ	1500M
27-1025	110V / 60HZ	2500M
27-1026	220V / 50HZ	2500M

2. Wax Injectors - USA

Increase productivity with these heavy duty wax injectors. CLA approved.

- A swing out cover
- Double insulated no leak nozzle
- Built-in side drain for clean up
- Uses an external air source
- Air regulator and pressure gauge 0-30 PSI
- Liquid filled thermostat ensures accurate temperature
- Ambient to 120° C/250° F

CAPACITY	1½QT. SUPER MINI	2¼QT.	4QT.
DIMENSIONS	Ø 10½" X 12"	Ø 10½" X 14"	Ø 10½" X 19"
WT.	15 LBS	28 LBS	32 LBS

ITEM #	SPECIFICATION	CAPACITY
27-1031	110V / 60HZ	1½ qt.
27-1032	220V / 50HZ	1½ qt.
27-1033	110V / 60HZ	2¾ qt.
27-1034	220V / 50HZ	2¾ qt.
27-1035	110V / 60HZ	4 qt.
27-1036	220V / 50HZ	4 qt.
27-1039	SPARE NOZZLE	



Kerr Accu Beads- See page # 332

Item	Injection Temp.	Flow	Flexibility	Carvability	Shrinkage	Memory	Application
Aqua Green	150°F / 65°C	High	Med.	Low	Low	Med.	All Purpose
Ruby / Red	150°F / 65°C	High	Med.	Low	Low	Med.	
Turqu. /Blue	150°F / 65°C	High	Med.	Low	Low	Med.	
Flex Plast	155°F / 68°C	Med.	Highest	Med.	Med.	High	Longest Shelf Life
NYC / Pink	155°F / 68°C	High	Med.	Low	Low	Med.	Highest Detail Easy Removal
Tuffy / Green	165°F / 73°C	Med.	High	Med.	Low	Med.	Large Pieces Toughest
Super / Pink	150°F / 65°C	High	Low	Med.	Low	Low	Bezel Setting Quickest Solidification
Accu / Carve	174°F / 79°C	High	High	High	Low	Med.	Highly carvable



3. Standard Vulcanizer

An excellent vulcanizer in a rigid box frame. Cast iron construction. The upper platen slides on twin guides and is raised and lowered by a central screw. All the electronic controls are enclosed in the base. CLA approved.

Features:

- Steel platens measure 5" X 8"
- Maximum opening 3"
- Platen alignment by guide bars
- Ceramic heating element
- Thermostat, pilot and on/off switch
- Temperature range 100°F-450°F
- Dimensions 15" X 8" X 18"
- Wt. 35 lbs



ITEM #	SPECIFICATION
27-1051	110V / 60HZ
27-1052	220V / 50HZ
27-1053	HEATING ELEMENT

4. Deluxe Vulcanizer

A robust heavy duty vulcanizer for medium production. One piece ribbed cast iron construction with dual guide bars for accurate alignment and even pressure distribution. All the electronic controls are enclosed in the base. CLA approved.

Features:

- Steel platens measure 6" X 8"
- Maximum opening 4"
- Twin guide bars with pressure screw
- Ceramic heating element
- Thermostat, pilot lamp, and on/off switch
- Temperature range 100°F-450°F
- Dimensions 14" X 9" X 20"
- Wt. 50 lbs



ITEM #	SPECIFICATION
27-1056	110V / 60HZ
27-1057	220V / 50HZ
27-1058	HEATING ELEMENT

5. Duplex Vulcanizer- Italy

An excellent vulcanizer for heavy duty production. Time tested and proven to be the best the world over. All units are built to precision standards and factory calibrated. The Duplex multifunction vulcanizer is designed to operate in two modes using the same machine.

Basic Version: is an open frame with clear view to position the flask in the center of the platen.

Features:

- Steel platens measure 150 x 150 MM
- Digital thermostat
- Built in timer 0-120 mins.
- Precise control up to 392° F/ 200° C ±1 C
- Analog timer -120 minutes
- Dimensions 280 X 210 X 450 MM
- Wt. 56 lbs



ITEM #	SPECIFICATION
27-1061	BASIC MODEL 110V / 60HZ
27-1062	BASIC MODEL 220V / 50HZ

Deluxe Version: This unit has the same structure as the basic version but is provided with an integral guard to prevent accidental contact with the heating plates.

Features:

- Steel platens measure 150 x 150 MM
- Digital thermostat
- Built in timer 0-120 mins.
- Precise control up to 392° F/ 200° C ±1 C
- Analog timer -120 minutes Digital thermostat
- Dimensions 280 X 210 X 450 MM
- Wt. 60 lbs



ITEM #	SPECIFICATION
27-1066	DELUXE MODEL 110V / 60HZ
27-1067	DELUXE MODEL 220V / 50HZ

See the operations in two Modes as described below.

MODE-I

In this mode the upper heating platen (2) transmits the heat to the flask(4) while the central piston (3) descends inside the flask, to compress the rubber mold (6). Use this method for cylindrical or rectangular flasks with metal spacers sliding inside (7) (8).

- Pressure screw (1)
- Flask (4)
- Lower heating plate (5)
- Kit attachment screws (7)

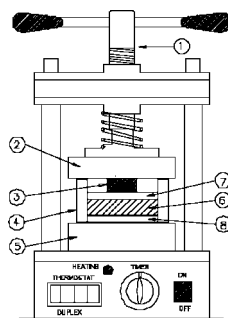

MODE-II

In this mode the descent of the central piston can be blocked by using a kit that is supplied with the machine. The kit consists of a metal plate 150 x 150mm (3) to fit to the upper heating platen (2). In this mode the upper heating platen not only transmits the heat but also compresses the rubber mold (6).

This is the best method for using rectangular flasks without internal sliding spacers.

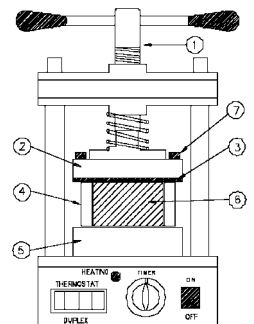



The Professional Jewelry Molding Rubber

A superior quality Mold Rubber for a full range of applications conveniently cut to size-strips, sheets and rolls.



6. Gold Label® -Molding Rubber

This is a soft, natural, pliable rubber. It has the ideal characteristics for difficult molds containing undercuts, filigree and settings. Rubber is 1/8" thick and vulcanizes at 310°F- 15 minutes for 1/4" mold frame thickness.

ROLLS	ITEM #	WT.
18" X 1/8"	27-1611	5 lb
	27-1612	50 lb
STRIPS 18" X 2 7/8" X 1/8"	27-1613	1 lb
	27-1614	5 lb
	27-1615	50 lb
REDI-CUT 2 7/8" X 1 7/8" X 1/8"	27-1616	5 lb
QUADROTTO 18" X 18" X 1/8"	27-1617	10 lb
	27-1618	50 lb



7. White Label® -Molding Rubber

Firm and flexible. A good all purpose mold rubber that is suited for thin molds. Rubber is 1/8" thick, vulcanizes at 310°F -15 minutes for 1/4" mold frame thickness.

ROLLS	ITEM #	WT.
18" X 1/8"	27-1621	5 lb
	27-1622	50 lb
STRIPS 18" X 2 7/8" X 1/8"	27-1623	1 lb
	27-1624	5 lb
	27-1625	50 lb
REDI-CUT 2 7/8" X 1 7/8" X 1/8"	27-1626	5 lb
QUADROTTO 18" X 18" X 1/8"	27-1627	10 lb
	27-1628	50 lb



8. No-Shrink Pink® -Molding Rubber

Shrinkage as low as 0%. High adherence for detail and excellent memory. May be used alone or combined with Gold Label® or White Label® on the outside of the mold to save costs.

STRIPS	ITEM #	WT.
18" X 2 7/8" X 1/8"	27-1633	1 lb
	27-1634	5 lb
REDI-CUT 2 7/8" X 1 7/8" X 1/8"	27-1636	5 lb
QUADROTTO 18" X 18" X 1/8"	27-1637	10 lb
	27-1638	50 lb



No-Shrink Pink Eliminates shrinkage. No difference in size between the model and finished casting.

9. Econosil® -Molding Rubber

This is a harder, firmer version of "Super High Strength" jewelry molding rubber at lower cost. Econosil is a putty-like material that makes strong, tough rubber molds. Red brown in color, it cuts like butter, gives waxes a high shine finish and requires no messy sprays. Waxes self release easily. Vulcanizes at 330°F - 15 minutes per layer of rubber.



Econosil™ STRIPS	ITEM #	WT.
18" X 2 7/8" X 3/8"	27-1654	5 lb
	5 lb. / 2.27 kg Bx.	

10. VLT™ - Molding Rubber

Make rapid molds from prototypes. VLT produces highly detailed wax injections with an extraordinary shiny surface that requires less finishing. Vulcanizes at temperatures as low as 160°F/71°C making it ideal for creating tough, strong rubber molds directly from all types of plastic resin models.



VLT™ STRIPS	ITEM #	WT.
18" X 2 7/8" X 3/8"	27-1658	5 lb
	5 lb. / 2.27 kg Bx.	

11. Titanium Label™ - Molding Rubber

Titanium Label extra firm, hard but still flexible. This molding rubber cuts, bends, flexes and stretches just like the White Label and Gold Label rubber.

- Less pattern distortion
- Reduced rubber shrinkage
- Higher clamping pressures
- Higher injection pressures
- Lower injection temperatures
- Better detail
- Reduced pattern shrinkage

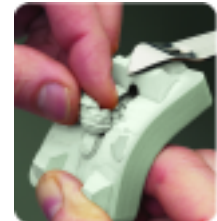

STRIPS	ITEM #	WT.
18" X 2 7/8" X 1/8"	27-1643	1 lb
	27-1644	5 lb
	27-1645	50 lb
REDI-CUT 2 7/8" X 1 7/8" X 1/8"	27-1646	5 lb
QUADROTTO 18" X 18" X 1/8"	27-1647	10 lb
	27-1648	50 lb



12. Gelato™ Super High Strength™

A super high strength molding rubber that cuts like butter. It resists tearing and is strong enough to make complex molds. Stronger than silicone rubber the molds last longer, have a shiny finish and that means less polishing of your castings. Mold packing is easy to do, just press it in with your fingers like putty.

STRIPS	ITEM #	WT.
18" X 2 7/8" X 3/8"	27-1661	5 lb
TAN	5 lb. / 2.27 kg Bx.	
18" X 2 7/8" X 3/8"	27-1662	5 lb
PISTACHIO	5 lb. / 2.27 kg Bx.	
18" X 2 7/8" X 3/8"	27-1663	5 lb
LEMON	5 lb. / 2.27 kg Bx.	
18" X 2 7/8" X 3/8"	27-1664	5 lb
PEACH	5 lb. / 2.27 kg Bx.	
18" X 2 7/8" X 3/8"	27-1665	5 lb
FUCHSIA	5 lb. / 2.27 kg Bx.	
18" X 2 7/8" X 3/8"	27-1666	5 lb
VIOLET	5 lb. / 2.27 kg Bx.	
18" X 2 7/8" X 3/8"	27-1667	5 lb
BLUE	5 lb. / 2.27 kg Bx.	
18" X 2 7/8" X 3/8"	27-1669	5 lb
ASSORTED	5 lb. / 2.27 kg/Bx.(All seven colors)	

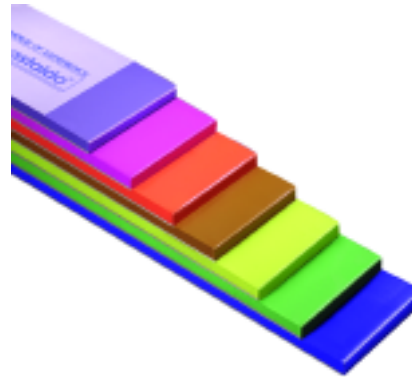

Just look at the shine!
A shiny finish on your molds means less polishing on your casting.

Molds Self Release!
There is no need for messy powder or mold release spray.

Mold packing is easy!
Spread and press it in with your fingers, just like putty.



St. Louis 13. Vacuum Investment Mixers

The only patented system to blend investment for fusion, eliminating any presence of gas. This mixer blends the investment under vacuum, shortens working time and is user friendly. The machine guarantees a better environment both for the operator and others working in the same area. The sealed system eliminates toxic dust from the atmosphere.

- Complete de-gassing of the investment
- Various mixer speeds suitable for every type of investment
- Memorization of mixing time

27-1071/1072



27-1076



27-1077

Model	Item #	Dimensions cm.	Weight kg.	Power Supply	Investment Capacity	Flask Plate Ø	Max. Flask Capacity	Vacuum Pump cbm/h / Stand
92-2	27-1071	28 X 35 X 85H	19 KG	110V S/PHASE	2 KG	140MM	1 Ø MM. 120X150H	6- NOT INCLUDED
92-2	27-1072	28 X 35 X 85H	19 KG	220V S/PHASE	2 KG	140MM	1 Ø MM. 120X150H	6- NOT INCLUDED
92-4	27-1073	28 X 35 X 95H	21 KG	110V S/PHASE	4 KG	175MM	1 Ø MM. 150X200H	6- NOT INCLUDED
92-4	27-1074	28 X 35 X 95H	21 KG	220V S/PHASE	4 KG	175MM	1 Ø MM. 150X200H	6- NOT INCLUDED
82-6	27-1076	42 X 42 X 105H	39 KG	220V S/PHASE	6 KG	280MM	4 Ø MM. 90X160H	18-NOT INCLUDED
82BP-6	27-1077	42 X 50 X 185H	87 KG	220V S/PHASE	6 KG	280MM	4 Ø MM. 90X160H	18-INCLUDED
	27-1075	VACUUM PUMP FOR 92 MODEL-ITALY						
	27-1078	VACUUM PUMP FOR 82-6 MODEL-ITALY						



14. Moldmatic® Ready Made Molds

An easy way to make molds.
Use these ready made molds, with a Moldmatic frame. Mold locks are pre-formed. Simply remove the protective cloth at the mold center and insert your model. After vulcanization, pull the edges apart. NSP* - No Shirnk Pink
Sold bx/10



SMALL	ITEM #	TYPE
1 7/8" X 2 7/8"	27-1671	WHITE LABEL
	27-1672	GOLD LABEL
	27-1673	NSP*
MEDIUM	27-1674	WHITE LABEL
	27-1675	GOLD LABEL
	27-1676	NSP*
2 3/8" X 3"	27-1677	WHITE LABEL
	27-1678	GOLD LABEL
	27-1679	NSP*

16. Mold Lock Formers

Brass metal cones that have projections on one side to lock into the base. Use one in each corner to locate the top half of the mold. Tapered shape prevents the mold from displacement during injection. Approx. 155 pcs.



ITEM #	DESCRIPTION
27-1681	MOLD LOCKS 3 OZ PKG

18. Moldmatic® Mold Frames

High precision frames for Ready Made Mold system. Three different sizes are available. Will fit any standard vulcanizer.

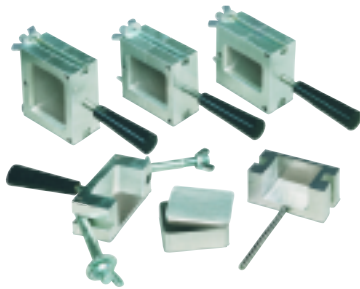

ITEM #	DESCRIPTION	SIZE
27-1683	SMALL	1 7/8" X 2 7/8" X 3/4"
27-1684	MEDIUM	2 3/8" X 3" X 3/4"
27-1685	LARGE	2 7/8" X 3 3/8" X 3/4"

15. Ferris® See-Thru Mold Frames

Aluminum U-frame with a sprue former. Two glass panels, one on each side, are held together with a pair of spring clips. Easy to assemble and ideal for use with LMR Rubber Set.



ITEM #	DESCRIPTION	H X W X T
27-1601	MOLD FRAME	3" X 2" X 5/8"
27-1602	MOLD FRAME	3" X 2" X 3/4"
27-1603	MOLD FRAME	3" X 2" X 1"
27-1604	MOLD FRAME	3" X 2" X 1 1/4"
27-1605	MOLD FRAME	3" X 2" X 1 1/2"
27-1606	MOLD FRAME	3" X 2" X 2"
27-1609	SPARE GLASS (PAIR)	

17. LiquaCast® Liquid Mold Rubber

A two part liquid rubber compound that vulcanizes overnight without any heat or pressure. Contains no silicone, but makes a strong durable mold for waxes and plastics.



ITEM #	DESCRIPTION
27-1691	LIQUID MOLD RUBBER- 1 LB KIT
27-1692	LIQUID MOLD RUBBER- 10 LB KIT
27-1693	LIQUID MOLD RUBBER- 50 LB KIT

19. LiquaGlass

- A clear version of LiquaCast
- 0% shrinkage RTV (room temperature vulcanizer)
- No need to bake in an oven
- Clear as glass, easy to pour



ITEM #	DESCRIPTION
27-1695	LIQUA GLASS -2 LB PACK



20. Quick-Sil® RTV Molding Rubber

A safe, non-toxic two part silicone rubber-mix that is pliable. Cures in about 15 minutes at room temperature. The rubber must be pressed or clamped in order to provide good detail. Good tear resistance with minimal shrinkage.

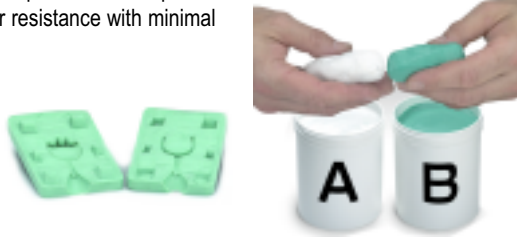

ITEM #	DESCRIPTION
27-1696	RTV MOLDING RUBBER -2 LB KIT

22. Mold Cream

On the surface of the mold parting line spread a small amount of cream with a finger or brush. After vulcanizing the mold will tear apart without the use of a surgical knife.



ITEM #	DESCRIPTION
27-1699	MOLD CREAM - 1 OZ / 28G

24. Soft Grip Knife

Non-slip, soft grip handle knife has a knurled screw locking arrangement for blades. Replacement blades are available. Overall length 5".



ITEM #	DESCRIPTION
27-1711	SOFT GRIP KNIFE WITH BLADES
27-1712	REPLACEMENT BLADES- 5 PCS

26. Sprue Rod Former/Sprue Mandrel

Brass sprue former with a cone point to match the wax injector nozzle. Sprue tip may be heated to form the entry hole.



ITEM #	SPECIFICATION
27-1721	BURNING MANDREL
27-1722	SPRUE FORMER 3/16" - CONE
27-1723	SPRUE FORMER 1/8" - HALF ROUND

21. Jewelry Mold Release Spray

A safe non-toxic silicone based spray to release wax patterns from rubber molds. Non-flammable, non-CFC and environmentally safe.



ITEM #	SPECIFICATION
27-1697	MOLD RELEASE -12 OZ (340 GM)

23. Resin Release™

A soy based product that is colorless, odorless and environmentally safe. Helps release models from VLT vulcanized rubber molds.



ITEM #	SPECIFICATION
27-1698	RESIN RELEASE -12 OZ (340 GM)

25. Sprints® Mold Release Spray

A silicone based odorless spray to release wax patterns from rubber or metal molds. Non-toxic, non-CFC and non-flammable. Environmentally safe. Completely EPA compliant.



ITEM #	DESCRIPTION
27-1715	MOLD RELEASE -12 OZ (340 GM)

27. IKOHE LMR- Liquid Mold Rubber

A room temperature vulcanizing rubber that requires no vulcanizer or oven. Absolutely no shrinkage. Good tear strength, durability and memory. Ideal for prototypes and limited production.



ITEM #	DESCRIPTION
27-1716	LMR KIT WITH CATALYST- 1 LB
27-1717	LMR KIT WITH CATALYST- 10 LB
27-1718	LMR KIT WITH CATALYST- 50 LB



28. Mold Cutting Blades & Knife Handles

Made of high impact plastic, and shaped for a comfortable grip, these handles hold surgical cutting blades securely. Replacement blades are available.



ITEM #	DESCRIPTION
27-1701	BLADE #10A - BX/100
27-1702	BLADE #11 - BX/100
27-1703	BLADE #12 - BX/100
27-1707	KNIFE HANDLE #3
27-1708	KNIFE HANDLE- PLASTIC

29. Aluminum Mold Frames

Made of aluminum with a single or double cavity. Side holes provide an escape channel for the excess rubber during vulcanization.



W X D X T	SINGLE	DOUBLE
1 ⁷ / ₈ " X 2 ⁷ / ₈ " X 1 ¹ / ₂ "	27-1561	27-1571
1 ⁷ / ₈ " X 2 ⁷ / ₈ " X 3 ³ / ₄ "	27-1562	27-1572
1 ⁷ / ₈ " X 2 ⁷ / ₈ " X 5 ⁵ / ₈ "	27-1563	27-1573
1 ⁷ / ₈ " X 2 ⁷ / ₈ " X 1"	27-1564	27-1574
1 ⁷ / ₈ " X 2 ⁷ / ₈ " X 1 ¹ / ₄ "	27-1565	27-1575
1 ⁷ / ₈ " X 2 ⁷ / ₈ " X 1 ¹ / ₂ "	27-1566	27-1576
2 ¹ / ₂ " X 3 ³ / ₄ " X 1"	27-1567	

30. Aluminum Multiple Frames

Single piece aluminum frames with multiple cavities for production. Side holes provide an escape channel for the excess rubber during vulcanization.

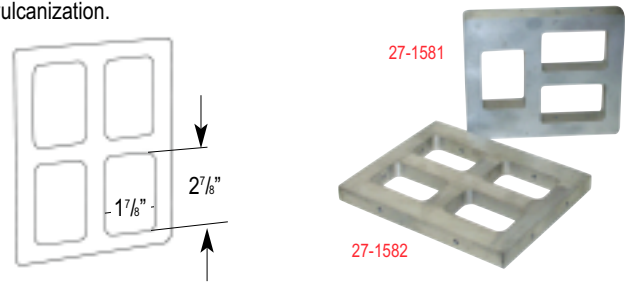

7 in 1 Mold Frame: Consists of three frames that can be assembled to get a mold of the desired thickness. Combinations assemble to the following thickness 1/2", 5/8", 3/4", 11/8", 1 1/4", 1 3/8" & 1 7/8".



ITEM #	DESCRIPTION
27-1581	3 IN 1 (1 ⁷ / ₈ " X 2 ⁷ / ₈ " X 7 ⁷ / ₈ ")
27-1582	4 IN 1 (1 ⁷ / ₈ " X 2 ⁷ / ₈ " X 3 ³ / ₄ ")
27-1583	4 IN 1 (1 ⁷ / ₈ " X 2 ⁷ / ₈ " X 1")
27-1584	4 IN 1 (1 ⁷ / ₈ " X 2 ⁷ / ₈ " X 1 ¹ / ₂ ")
27-1587	7 IN 1 (1 ⁷ / ₈ " X 2 ⁷ / ₈ ")

31. Mold Mate

A cutting board and two clamps to aid mold separation. Permits all around access and helps to increase production.



ITEM #	DESCRIPTION
27-1597	MOLD MATE 6" X 14"
27-1598	MOLD MATE JUNIOR

32. Mold Frame Plates

Smooth flat aluminum plates in different sizes to cover the top and bottom of the mold frames when vulcanizing.

Sold in pairs.



ITEM #	DESCRIPTION
27-1591	MOLD FRAME- 2 ¹ / ₂ " X 3 ¹ / ₂ "
27-1592	MOLD FRAME- 3 ⁷ / ₈ " X 5 ³ / ₈ "
27-1593	MOLD FRAME- 4" X 6"
27-1594	MOLD FRAME- 5" X 7 ¹ / ₈ "



KerrLab Satin Cast Investment

- Produces satin smooth, consistently superior casting results • Creates a dense casting by vacuum and centrifugal methods
- Reduces finishing time and increases productivity • Mixes to a smooth consistency • Forms a strong yet permeable mold • Breaks away cleanly and easily



33. Satin Cast-20

A premier casting investment that blends to a smooth creamy consistency. Includes wetting agents to create a composite high strength mold.

For gold, silver, brass and other metals melting under 2000° F / 1093° C

- 27-1741 45 KG DRUM
- 27-1742 15 KG CARTON
- 27-1743 2 KG CANISTER (6PK)



37. KerrCast-2000

A precision investment that offers super smooth surfaces, a reduced burnout cycle and easy breakout.

For gold, silver, brass and other metals melting under 2000° F / 1093° C

- 27-1744 45 KG DRUM



34. Supervest 20™

Formulated with a thicker slurry than Satin Cast 20. Ideal for both jewelry and small sculpture.

For gold, silver, brass and other metals melting under 2000° F / 1093° C

- 27-1745 45 KG DRUM



35. Satin Cast Diamante®

The newest addition, this investment is specially formulated for stone in place casting while offering the benefits of Satin Cast 20.

For gold, silver, brass and other metals melting under 2000° F / 1093° C

- 27-1747 45 KG DRUM



38. Opticast™

A platinum investment delivering incomparable surface finish and mold strength. Its high permeability produces crisp, dense patterns while minimizing inclusions.

- 27-1752 OPTICAST 35 KG
- 27-1753 OPTI-BIND 8 OZ (CAT.) CASE/4



36. Satin Cast Xtreme®

Contains a higher percentage of cristobalite, allowing for a higher temperature tolerance for easier casting of 18 karat white metals.

For gold, silver, brass and other metals melting under 2000° F / 1093° C

- 27-1746 45 KG DRUM



39. Platinite

High strength, high temperature investment for casting platinum and stainless steel alloys. Delivers casting with sharp detail. Good dimensional accuracy.

- 27-1751 45 KG DRUM

40. Pandora Alloys for Casting and Mechanical Works

High purity alloys when added to 24kt gold will create a lower karat and color of your choice. The alloys listed offer the optimum balance between color and workability. Sold in troy ounces.

ITEM #	USE FOR KARAT	COLOR	APPLICATION
27-2001	8-9-10-14kt	2P14/PO Yellow	Casting
27-2011	8-9-10-14kt	2P14/PA Yellow	Mechanical
27-2021	8-9-10-14kt	5P18/L Pink	Casting
27-2031	18kt	2P18/GZ Yellow	Casting- Mechanical
27-2041	8-9-10-14kt	EC-White	Mechanical
27-2051	14-18kt	C/M White	Mechanical
27-2061	8-9-10-14kt	ESZ White	Casting
27-2071	14-18kt	EM White	Casting
27-2081	800-925	1P/AG-U Silver	Casting- Anti-tarnish

- Casting temperature should be approximately 100-150°F above melting temperature
- Casting temperature will vary slightly depending upon the particular alloy used
- Flask temperature will vary depending on the size of the casting
- Casting grain alloy is a mixture of gold and other specialty alloying metals
- Mixture is ready to be melted and cast or poured into an ingot mold for rolling or drawing





41. Investment Mixer

A planetary blending system to mix generous quantities of investment. The mix is of a consistent density without air entrapment. Bowl and whip are of stainless steel. Capacity 4½ Qt.



ITEM #	DESCRIPTION
27-1511	K45 - 110V/60HZ
27-1512	K45 - 220V/50HZ
27-1513	SS REPLACEMENT BOWL- 4½ QT.
27-1514	SS REPLACEMENT WHIP

42. Investment Mixing Bowls- Rubber

Bowls in two sizes, made in hard long lasting rubber. Ideal for mixing investment powder.



27-1501

27-1502

ITEM #	DESCRIPTION	DIMENSIONS
27-1500	SMALL - 1¼" PT.	4½"W
27-1501	MEDIUM - 1½" QT.	6"W
27-1502	JUMBO - 1 GAL.	10"W

43. Hydro Air Wash Gun

Reduce cleaning time while removing investment from castings. The wash gun uses water and compressed air (¼") at 70 -200 PSI. Connects to a sink faucet with ¾" hose connection.



Nose protector

Rubber hand grips

Set Includes: Trigger air valve, nose protector and rubber hand grips.

ITEM #	DESCRIPTION
27-1555	HYDRO AIR GUN

44. Investment Vibrator

- Reduces air bubbles and voids around wax patterns
- Round top for flask up to 4.25"
- Compact design with variable speed
- Dimensions: 150 x 150 x 110mm
- Wt. 4 lbs



ITEM #	DESCRIPTION
27-1559	INVESTMENT VIBRATOR-110V/60HZ
27-1560	INVESTMENT VIBRATOR-220V/50HZ

45. Investment Spatula

Useful for mixing, forming or shaping wax or clay. Conveniently sized stainless steel rounded blade with handle. Overall length 8½".



ITEM #	DESCRIPTION
27-1506	SPATULA- 5½" BLADE

46. Dial Thermometer

Dual scale stainless steel thermometer with an 8" stem. Use to calibrate vulcanizers.



ITEM #	RANGE
27-1517	50° - 400°F/ 10-200°C

47. Investment Scale

Easy to read dial scale with a removable pan to transfer investment to mixer. Dimensions: 10" X 7" X 16" Ht.



ITEM #	DESCRIPTION
27-1508	SCALE - CAPACITY 20 LBS

48. Investment Remover

Non-corrosive, non-foaming solution formulated for fast clean up of castings. Mix one part of solution with five parts of water. Not for use on aluminum, pearls or calcified stones.



ITEM #	DESCRIPTION
27-1557	INVESTMENT REMOVER- 1 GAL.

49. Investment Scoop

Plastic investment scoop has high supporting sides to avoid spillage and waste. Dimensions: 8½" X 4¼" X 3"



ITEM #	DESCRIPTION
27-1504	SCOOP - CAPACITY 3 LBS



50. Regular Flasks

Durable 14 ga stainless steel flasks are corrosion resistant. Withstands thermal shock during quenching. All surfaces of the flasks have a smooth finish and edges are machined for optimum sealing.



HEIGHT	2 1/2"	3"	4"	5"	6"
Ø 2"	27-1401	—	—	—	—
Ø 2 1/2"	27-1406	27-1407	27-1408	27-1409	—
Ø 3"	27-1411	27-1412	27-1413	27-1414	27-1415
Ø 3 1/2"	27-1416	27-1417	27-1418	27-1419	27-1420
Ø 4"	—	27-1422	27-1423	27-1424	27-1425

51. Flask Sleeves

Reusable flexible rubber sleeves slide on to the outside of the perforated flasks while investing. After the investment has set, the sleeves may be removed.



ITEM #	DESCRIPTION	Ø X HT
27-1471	FLASK SLEEVE	3 3/8" X 4"
27-1472	FLASK SLEEVE	4" X 6"
27-1473	FLASK SLEEVE	4" X 7"
27-1474	FLASK SLEEVE	4" X 8"

52. Flask Extender

Used on solid wall flasks to prevent overflow of investment. Made of flexible rubber, the sleeves stretch over the flask end.



ITEM #	DESCRIPTION	Ø X HT
27-1481	FLASK EXTENDER	2 1/2" X 4"
27-1482	FLASK EXTENDER	2 3/4" X 4"
27-1483	FLASK EXTENDER	3" X 4"
27-1484	FLASK EXTENDER	3 1/2" X 4"
27-1485	FLASK EXTENDER	4" X 4"

53. Perforated Flasks

Heavy gauge perforated flasks, in 6 ga stainless steel. Withstands thermal shock and corrosion. Ideal for use on vacuum casting machines.

Provides complete air withdrawal which results in a denser casting. Clean seamless welds and precision machined surfaces.



HT.	4"	5"	6"	7"	8"	8 1/2"	9 1/2"
Ø 3"	27-1431	—	—	—	—	27-1436	—
Ø 3 3/8"	27-1438	—	—	—	—	—	—
Ø 3 1/2"	27-1445	27-1446	27-1447	27-1448	27-1449	27-1450	27-1451
Ø 4"	27-1452	27-1453	27-1454	27-1455	27-1456	27-1457	27-1458
Ø 5"	—	—	—	27-1462	27-1463	—	—

54. High Pressure Water Jet Plaster Remover

- A high pressure blaster for removing investment off models, trees after casting
- Rugged stainless steel booth with supporting stand
- The unit has a large viewing window and is well illuminated
- Rubber gloves are mounted on the front for maneuvering items inside the chamber
- Environmentally friendly, uses high pressure water jet at 120 Bar

SPECIFICATIONS:

PUMP HP:	2.2 HP
PRESSURE:	120 BAR
DIMENSIONS:	25" X 20" X 50"
WEIGHT:	70 LBS

Unit Includes:

Pressure Pump at 120 Bar.
High Pressure Hose for connecting to washing booth.
Supporting Trolley.



ITEM #	DESCRIPTION
27-1551	HP* BLASTER 110V / 60 HZ
27-1552	HP* BLASTER 220V / 50 HZ



55. Non-Asbestos Paper Rolls

Non asbestos paper is required to absorb the excess binder moisture when investing platinum. The paper is used as a liner prior to pouring the investment. Use a single layer on the inside of the flask and a double layer at the bottom.



ITEM #	W X T	LENGTH
27-1381	2 1/2" X 1/16"	50 FT
27-1382	4" X 1/16"	50 FT
27-1383	5" X 1/16"	50 FT
27-1384	7 1/4" X 1/16"	50 FT

56. High Temp Gaskets

Graphite impregnated gaskets used to seal flasks while vacuuming.



ITEM #	DESCRIPTION	Ø X T
27-1521	HIGH TEMP GASKET	3" X 1/8"
27-1522	HIGH TEMP GASKET	3 3/8" X 1/8"
27-1523	HIGH TEMP GASKET	3 1/2" X 1/8"
27-1524	HIGH TEMP GASKET	4" X 1/8"
27-1525	HIGH TEMP GASKET	4 1/2" X 1/8"
27-1526	HIGH TEMP GASKET	5" X 1/8"

57. Masking Tapes

Wide tapes to cover the holes on perforated flasks during investing. Easy to peel away after burn out.



ITEM #	WIDTH	LENGTH
27-1391	4"	60 YDS
27-1392	5"	60 YDS
27-1393	6"	60 YDS
27-1394	7"	60 YDS
27-1395	8"	60 YDS

58. Silicone Gaskets

Gaskets in different sizes used to seal flasks while vacuuming.



Ø	1/8" T	Ø	1/4" T
3"	27-1531	3"	27-1541
3 3/8"	27-1532	3 3/8"	27-1542
3 1/2"	27-1533	3 1/2"	27-1543
4"	27-1534	4"	27-1544
4 1/2"	27-1535		
5"	27-1536		
5 1/2"	27-1537		

59. Crucible with Handle

Melting dish with a removable heat resistant handle. Made of fused silica for efficient melting. Will not contaminate precious metals.



ITEM #	DESCRIPTION
27-1497	CRUCIBLE WITH HANDLE
27-1498	HANDLE ONLY
27-1261	CRUCIBLE 7 1/2" OZ.

60. Crucible Tongs

Steel tongs with curved or straight ends to hold heated crucibles while pouring molten metal into molds.

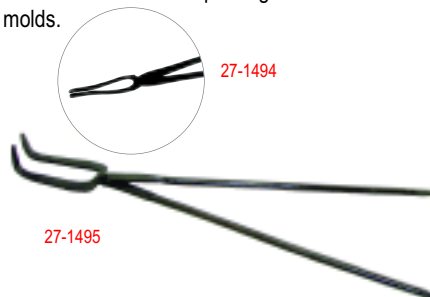

ITEM #	DESCRIPTION
27-1494	19" STRAIGHT
27-1495	19" CURVED

61. Flask Tongs

Light weight spring steel tongs used for holding small or large flasks.



ITEM #	DESCRIPTION
27-1492	15" FLASK TONG



62. Sprue Bases

Long lasting rubber bases for spruing all types of trees. Various shapes and different diameters are available with all sizes of button holes. Fits to flask size as given below.

Tree Style-C: Most popular sprue base with $\frac{3}{8}$ " hole, forming curved indentation in the investment.



ITEM #	FLASK Ø	BUTTON ID.
27-1351	1½"	$\frac{3}{8}$ "
27-1352	2"	$\frac{3}{8}$ "
27-1353	2½"	$\frac{3}{8}$ "
27-1354	3"	$\frac{3}{8}$ "
27-1355	3½"	$\frac{3}{8}$ "
27-1356	4"	$\frac{3}{8}$ "
27-1357	5"	$\frac{3}{8}$ "
27-1358	6"	$\frac{3}{8}$ "

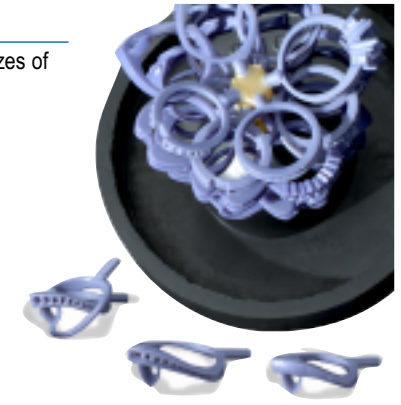

Sprue Wax
See Pg#328

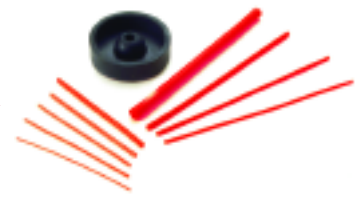

Tree Style-A: These sprue bases have a large diameter hole for filling with suitable wax for spruing.



ITEM #	FLASK Ø	BUTTON ID.
27-1361	2½"	$\frac{7}{8}$ "
27-1362	3"	1½"
27-1363	3½"	2"
27-1364	4"	2 $\frac{3}{16}$ "
27-1365	5"	2 $\frac{3}{16}$ "

Cone Tree Center-CT: These sprue bases have a $\frac{3}{8}$ " Ø hole. High tapered side to give extra support to sprue rod.



ITEM #	FLASK Ø
27-1371	2½"
27-1372	3"
27-1373	3½"
27-1374	4"
27-1375	5"

Donut Style-B: The tapered side of sprue hole is straight, not curved as in style "C"



ITEM #	FLASK Ø
27-1366	2½"
27-1367	3"
27-1368	3½"
27-1369	4"

Universal Sprue Base:
Suitable for two flask sizes 2½" and 3½", similar to style "CT"



ITEM #	DESCRIPTION
27-1376	UNIVERSAL SPRUE BASE

63. Sprue Base Holder

Very convenient for fast tree assembly. May be adjusted to any convenient angle. Suitable for sprue bases from 3"-5".

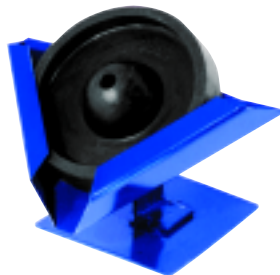

ITEM #	DESCRIPTION
27-1378	SPRUE BASE HOLDER

64. Base Mate®

Holds sprue bases for treeing. Tilts up or down and rotates for perfect viewing at any angle. Includes spring tension ring for 3½" and 4" sprue bases.

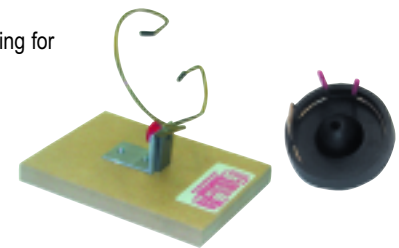

ITEM #	DESCRIPTION
27-1379	BASE MATE



65. Inva-Cast Vacuum Machine

Bench top unit that allows investment of both standard and perforated flasks using vacuum technology. Superior air bubble elimination for cleaner, denser molds. Easy to operate, the machine produces consistent results, while reducing the risk of casting defects. An additional feature is the low maintenance aspect of filters, lines and pump. The system includes all the essentials for vacuum casting.



Unit Includes: Vacuum pump, 3", 3 $\frac{3}{8}$ " and 4" rubber seal, 3" x 3 $\frac{3}{8}$ " perforated flask, sprue base, flask tongs, silicone vacuum seal 7 $\frac{1}{2}$ " round, bell jar 8" x 9" and vacuum pump oil. Instructions included.
Dimensions: 22" x 14" x 15" ht. Wt. 90 lbs

ITEM #	DESCRIPTION
27-1081	INVA-CAST 110V / 60 HZ.
27-1082	INVA-CAST 220V / 50 HZ.
Accessories for inva-Cast	
27-1085	VACUUM PUMP OIL 1 QT.
27-1086	SILICONE GASKET FOR 3" FLASK
27-1087	SILICONE GASKET FOR 3 $\frac{3}{8}$ " FLASK
27-1088	SILICONE GASKET FOR 4" FLASK
27-1089	BELL JAR 8" X 9"

Table Pads

A rubber pad for use in vacuum casting under the bell jar. The silicone pad (red) is of premium quality and long lasting.



ITEM #	DESCRIPTION
27-1091	11" SQUARE- RUBBER
27-1092	7" Ø ROUND- SILICONE

66. Platinum Casting Machine

A vertical casting system for platinum specifically designed with a high starting torque to ensure quality castings before cool down occurs. The machine is mechanically driven by a set of heavy duty springs and enclosed with a shield for safety.

Unit Includes: Casting machine with shield.
Complete arm assembly with crucible carriage.
Instructions included.
Dimensions: 26" x 12" x 32" ht. Wt. 40 lbs

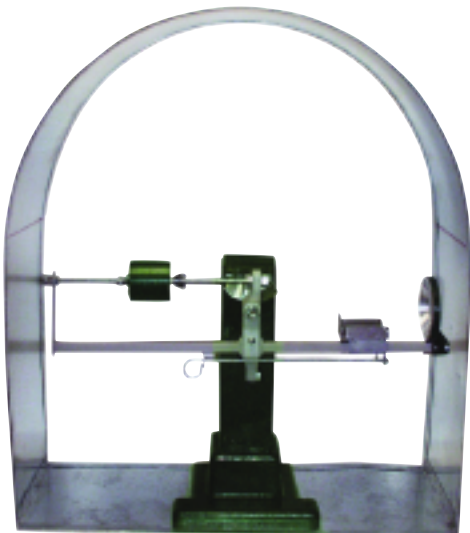

ITEM #	DESCRIPTION
27-1141	PLATINUM CASTING MACHINE WITH SHIELD-COMplete
27-1142	COMPLETE ARM ASSEMBLY
27-1143	BACKPLATE FOR FLASK
27-1144	CRUCIBLE CARRIAGE
27-1145	ARM ASSEMBLY FOR CRUCIBLE CARRIAGE
27-1146	SET OF 4 SPRINGS
27-1282	10 OZ. LARGE-D (SMALL ORIFICE)



67. Standard Vacuum - Machine for Investing & Casting

A compact bench top investing and casting machine. Use for vacuuming air and gas from flasks to ensure positive molten metal flow. A heavy duty vacuum pump creates negative pressure 27"-29" hg at sea level. Investing is done on the table which can be vibrated to eliminate air and gas bubbles. Maximum solid flask size Ø 4" X 6" height.

Unit Includes: Machine with vacuum pump, hose, crucible with handle, silicone gasket and complete instructions.

Dimensions: 14" X 14" x 18½" Ht. Wt. 48 lbs.

ITEM #	DESCRIPTION
27-1111	COMPLETE UNIT 110V/50HZ
27-1112	COMPLETE UNIT 220V/60HZ
27-1114	TABLE ONLY WITHOUT PUMP
27-1115	VACUUM PUMP AND OIL ONLY



68. Centrifugal Machine with Long Arm

A compact machine that protects the operator against accidental metal spillage from the whirling crucible. A heavy duty spring swings the long rotating arm so that metal is forced into the flask. Maximum flask, Ø 3½" X 5" ht. Unit is made of steel with a baked enamel finish. The base is drilled for fitment to bench. Recommended crucible 9 oz.

Unit Includes: Drive mechanism with long arm, balancing weights, cradle for 2½" Ø flask, sprue base, rubber mixing bowl, flask tongs, spatula and 10 lbs of investment. (without drum and cover)

Dimensions: 24" x 24" x 12" Ht. Wt. 18 lbs

ITEM #	DESCRIPTION
27-1131	COMPLETE UNIT
27-1132	DRUM ONLY (24" X 24")- 16 LBS
27-1133	COVER ONLY - 6 LBS



27-1131

27-1133

Unit shown with drum and cover

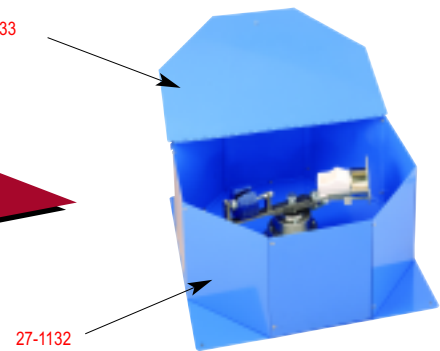

27-1132

69. Neycraft® Centrifugal Casting Machine

Engineered with safety in mind, the Neycraft centrifugal casting machine accommodates all standard size investment flasks up to 4" X 4", maximum metal capacity 9 oz. Spring loaded combination winding, locking and release mechanism. Heavy duty drive shaft rotates in sealed bearings.

Unit Includes: Machine with one silica crucible, universal flask tongs, one 2" Ø stainless steel investment flask, one 3" Ø flask and two sprue bases. Instructions included.

Dimensions: 20" X 20" X 12" Ht. Wt. 26 lbs

ITEM #	DESCRIPTION
27-1121	COMPLETE UNIT
27-1122	MAIN SPRING
27-1284	CRUCIBLE - 9 OZ



27-1122





70. Neycraft® Fiber Furnace

The only bench-top electric burn out furnace with a one piece molded heating chamber. The outer cabinet is sturdy steel construction and the fiber muffle has an embedded heating element. Energy efficient design with four wall heating for even heat distribution.

Features:

- Fast start up time- 15 min. to reach 1000°F
- Max. temperature 2000°F
- Dual temperature indicator in F/C°
- Top port for venting wax and water vapor
- Chamber accommodates a 6" flask
- Inside dimensions 9" X 9" X 6½"
- Outside dimensions 15" X 14½" X 16½"
- Wt. 36 lbs

All Furnace warranties excludes damage due to overfiring, exceeding melting temperature and improper electrical installation.



ITEM #	DESCRIPTION
27-1161	525 CU. INCH 110V/ 60HZ/1320W - JFF2000
27-1162	525 CU. INCH 220V/ 50HZ/1320W - JFF2000
27-1166	MUFFLE (EMBEDDED ELEMENT) -110V
27-1167	MUFFLE (EMBEDDED ELEMENT) -220V
27-1168	THERMOCOUPLE
27-1169	PYROMETER
27-1170	8" X 8" FLOOR TRAY

71. Fiber Burnout Furnaces

Energy efficient furnaces for jewelry and ceramic. The firing chamber is a one piece ceramic fiber shell with embedded elements. For greater thermal efficiency the space between the steel case and the fiber shell is packed with extra fiber insulation. The door seals tightly with a heavy spring latch. All the controls are located in the base. Reaches 1000 °F (538 °C) in 30 minutes. Firing chamber 13" X13" X 9" Ht. Pyrometer is not included.

Manual Furnace:

- Built in thermocouple
- Infinite control dial with pilot light
- Pyrometer location hole provided
- Outside dimensions: 19" x 18½" x 19"
- Wt. 108 lbs

Digital Furnace: (Programmable)

- Preset programs or customize your own
- Preset up to eight ramps and eight dwells
- Auto shut off if controller fails
- Controller stores up to 6 programs
- Outside dimensions: 19" x 18½" x 19"
- Wt. 108 lbs



27-1181

All Furnace warranties excludes damage due to overfiring, exceeding melting temperature and improper electrical installation.



27-1183

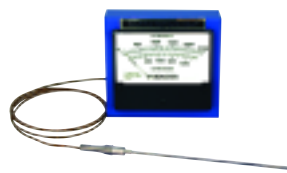

27-1185

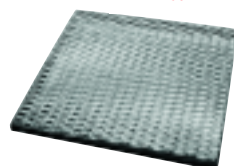

27-1189

ITEM #	DESCRIPTION
27-1181	MANUAL CONTROL 110V/ 60HZ
27-1182	MANUAL CONTROL 220V/ 50HZ
27-1183	DIGITAL 110V/ 60HZ
27-1184	DIGITAL 220V/ 50HZ
27-1185	PYROMETER - ANALOG
27-1186	PYROMETER - DIGITAL
27-1187	ELEMENT FOR 27-1181 / 27-1183
27-1188	ELEMENT FOR 27-1182 / 27-1184
27-1189	S.S WAX TRAY 12" X 12" X ¾"

72. Furnace Repair Cement

A high temperature cement for all types of firebrick kilns. Mix with water and repair cracks or broken sections. May also be applied as a dust free coating on the inner lid.

ITEM #	DESCRIPTION
27-1228	CEMENT BAG-1 LB

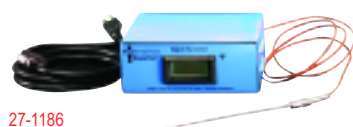

27-1186



73. Satellite Furnaces

Heavy duty steel construction with double coated protection in hammertone gray.
 Temperature ramp up from 0-700°F in 45 min. and 700-1400°F in an additional 15 min., approx.
Features include heavy duty element, side opening door, top venting for moisture and wax escape.
 Convenient front viewing of control panel. Maximum operating temp. 1800°- 2000°F.

Manual: Temperature and time are to be manually controlled.
Automatic: Includes a solid state relay that allows you to set and hold temperature, but not the time.
Digital: Holds up to six separate programmes, with eight segments per programme, set up and time.

Heating elements are not under warranty

All Furnace warranties excludes damage due to overfiring, exceeding melting temperature and improper electrical installation.



Manual Units: J-100 & J-200



Automatic Units: J-101 & J-201



Automatic Units: J-104 & J-204

DIMENSIONS		MANUAL		AUTOMATIC		DIGITAL (PROGRAMMABLE)	
CHAMBER:	8½" X 9" X 6¼"	27-1201	J100 -110V	27-1205	J101- 110V	27-1209	J104- 110V
		27-1202	J100- 220V	27-1206	J101- 220V	27-1210	J104- 220V
CHAMBER:	12" X 12" X 8½"	27-1203	J200 -110V	27-1207	J201- 110V	27-1211	J204- 110V
		27-1204	J200- 220V	27-1208	J201- 220V	27-1212	J204- 220V

ITEM #	DESCRIPTION
27-1215	ELEMENT 110V - ALL MODELS
27-1216	ELEMENT 220V - ALL MODELS
27-1217	THERMOCOUPLE K TYPE - ALL MODELS
27-1218	PYROMETER - ALL MODELS
27-1219	INFINITE CONTROL FOR J100 & J200

Satellite Furnace Spares Available



74. Saturn® Melter- Italy

Designed for melting metals for alloying and casting. Digital display for accurate temperature control with an on/off indicator. Built-in electronics protect the heating element.
 Maximum temperature 2050°F/1120°C.

Satrun 1 KG: Dimensions: 250 X 220 X 210mm Wt. 4 KG
Satrun 2 KG: Dimensions: 270 X 260 X 350mm Wt. 5.5 KG

Unit Includes: graphite crucible, stirring rod, tongs and complete operating instructions.

ITEM #	SPECIFICATION	CAPACITY
27-1231	110V / 60HZ / 0.7 KW	1 KG
27-1232	220V / 50HZ / 0.7 KW	1 KG
27-1233	110V / 60HZ / 1.1 KW	2 KG
27-1234	220V / 50HZ / 1.1 KW	2 KG
27-1235	CRUCIBLE -G59	1 KG
27-1236	CRUCIBLE - G121	2 KG



All Furnace warranties excludes damage due to overfiring, exceeding melting temperature and improper electrical installation.



27-1243



27-1241

Units include graphite crucible, carbon stirring rod and safety switch.



27-1245

All Furnace warranties excludes damage due to overfiring, exceeding melting temperature and improper electrical installation.



27-1255

27-1255



Heating Elements

ITEM #	DESCRIPTION
27-1247	KERR ELEMENT FOR MANUAL-110V
27-1248	KERR ELEMENT FOR MANUAL- 220V
27-1249	KERR ELEMENT FOR AUTO STD.-110V
27-1250	KERR ELEMENT FOR AUTO STD.- 220V
27-1251	KERR ELEMENT FOR AUTO MAXI -110V
27-1252	KERR ELEMENT FOR AUTO MAXI -220V
27-1254	CRUCIBLE FOR STD./ELECTOMELT-1 KG
27-1255	CRUCIBLE FOR MAXIMELT-3 KG

75. Kerr® Electro-Melt™ Furnace- Manual -Series 1258

Manual electro melts feature a temperature control that regulates the furnace by using a percentage of time on / time off principle. The dial is calibrated in numbers representing the percentage of time power is directed to the element. CE, UL & CUL CERTIFIED
Dimensions: 6" x 4" x 12" Wt. 15 lbs

Calibrated dial plate: 982°C / 1800°F in 22 min.

Maximum temperature: 1093°C / 2000°F

Melting capacity: Gold - 930g / 30 Troy oz

Silver - 775g / 25 Troy oz

27-1241 ELECTRO-MELT MANUAL 110V/ 60 HZ

27-1242 ELECTRO-MELT MANUAL 220V/50 HZ

Kerr® Electro-Melt™ Furnace-Auto Standard -Series 1258

A digitally controlled furnace when sustained high temperature is required. Electronic controller regulates the temperature by providing full power input until a pre-selected temperature is attained.

CE, UL & CUL CERTIFIED

Dimensions: 9" x 6" x 13" Wt. 15 lbs

Maximum temperature: 1120°C / 2050°F

21 minutes to 982°C / 1800°F

Melting capacity: Gold - 930 g / 30 Troy oz

Silver - 775 g/25 Troy oz

27-1243 ELECTRO-MELT STD. 110V/60 HZ

27-1244 ELECTRO-MELT STD. 220V/50 HZ

Kerr® Electro-Melt™ Auto Maxi -Series 1259

Digitally controlled, recommended when sustained high temperature is required. Electronic controller regulates the temperature by providing full power input until a pre-selected temperature is attained.

CE, UL & CUL CERTIFIED

Dimensions: 9" x 6" x 15" Wt. 15 lbs

Melting capacity: Gold - 3.1 kg / 100 Troy oz

Silver - 2.6 kg / 83 Troy oz

Maximum temperature: 1120°C / 2050°F

31 minutes to 982°C/1800°F

27-1245 ELECTRO-MELT -AUTO MAXI 110V

27-1246 ELECTRO-MELT -AUTO MAXI 220V

76. Stirring Rods

High heat resistant graphite or quartz stirring rods to stir molten metal in crucibles or dishes.



ITEM #	DESCRIPTION
27-1298	CARBON -12" X 3/8"
27-1299	QUARTZ -12" X 3/8"



77. Melting Dish- Regular

Quality made dish of fused silica with a clay bond. Best suited for all high temperature melting of metal alloys and precious metals.



ITEM #	CAPACITY	TYPE
27-1261	7½" OZ.	STRAIGHT BACK
27-1262	20 OZ.	HIGH BACK

78. Fused Silica Melting Dishes

Clay bonded fused silica melting dishes withstand temperatures up to 2800°F/1538°C. They have good thermal conductivity and will not contaminate metal alloys, chromium, gold or platinum.

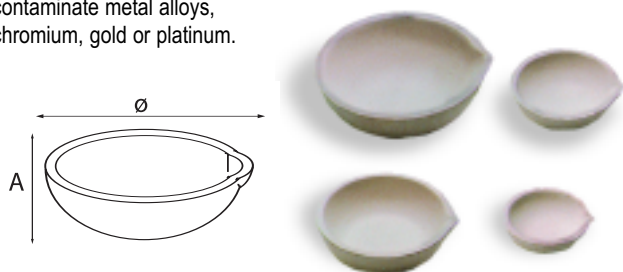

ITEM #	Ø X A	DWT	GRAMS
27-1271	1¾" X ⅝"	16	48
27-1272	2¼" X ¾"	19	96
27-1274	3" X 1"	25	155
27-1276	4" X 1⅜"	35	420

79. Crucibles for Centrifugal Casting

These fused silica crucibles are available in various styles and are designed with high side walls for extra safety when casting. Metals may be torch melted in these crucibles as they sustain high temperatures up to 2500°F/1370°C.

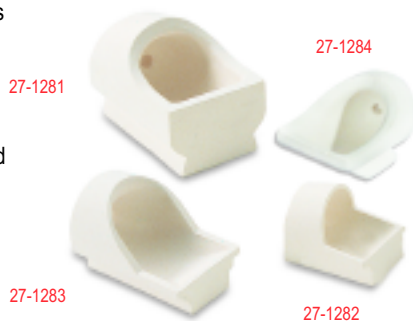

ITEM #	DESCRIPTION
27-1281	LARGE-A 3 OZ.
27-1282	LARGE-D SMALL ORIFICE 10 OZ.
27-1283	LARGE-D LARGE ORIFICE 11 OZ.
27-1284	NEY 9 OZ.

Using Ceramic Crucibles

To provide minimum oxidation in the casting of gold alloys, it is recommended that a thin film of borax be melted into the discharge path of an orifice prior to making the first melt in the crucible.

80. Morgan® Platinum Melting Dish

A melting crucible specifically for platinum, made by Morgan. Designed to withstand the high temperatures that are needed for platinum and precious alloys.



ITEM #	CAPACITY	TYPE
27-1266	8 OZ.	STRAIGHT BACK
27-1267	10 OZ.	HIGH BACK

81. Platinum Melting Dish- Japan

A top quality dish for high temperature metal melting, especially suitable for platinum.



ITEM #	DESCRIPTION
27-1268	MELTING DISH Ø 60MM
27-1269	MELTING DISH Ø 70MM

82. Salamander Graphite Crucibles

Natural graphite crucible with pouring spout, bonded with silicon carbide and fire clay. Lined with mullite for long life. These crucibles are resistant to high temperatures and thermal shock.



ITEM #	STYLE	H X A Ø X B Ø
27-1311	A1	3⅞" X 3⅜" X 2⅛"
27-1312	A2	4¼" X 3¾" X 2¼"
27-1313	A3	5" X 4⅞" X 2¾"
27-1314	A4	5½" X 4½" X 3"
27-1315	A5	6" X 4¾" X 3½"
27-1316	A6	6⅝" X 5⅞" X 3¾"
27-1318	A10	7⅞" X 6⅞" X 4⅞"

Lining Clay Crucibles

Clay crucibles need to be treated before use for extended life. Fill about 25% of the crucible with a mix of 50% borax* and boric acid*. Heat the crucible gradually until the mixture melts. Carefully tilt the crucible so as to coat the entire inner surface. Then pour the excess away and allow the crucible to cool to room temperature.

* See Page # 273



83. Heat Resistant Gloves

Non-asbestos, full inside lining with soft felt. Available in different sizes. Useful for handling hot items.



ITEM #	DESCRIPTION
27-1466	H/RESISTANT GLOVES 14" PAIR
27-1467	H/RESISTANT GLOVE 14" RIGHT ONLY
27-1468	H/RESISTANT GLOVES 18" PAIR
27-1469	H/RESISTANT GLOVE 18" RIGHT ONLY

84. Reversible Ingot Mold

Convert metal scrap into convenient and usable shapes: round, half round or flat. Pour molten metal into the pre-heated mold. Mold is in two parts for easy extraction.

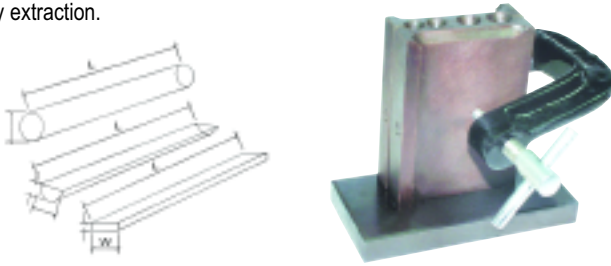

●	Ø MM	2	3	4	5
◐	Ø X W	2 X 1	3 X 1.5	4 X 2	5 X 2.5MM
■	T X W	4 X ADJUSTABLE FROM 15-45MM			

ITEM #	DESCRIPTION
27-1327	INGOT MOLD
27-1328	CLAMP ONLY

85. Wire Ingot Molds

Cast molten scrap into wire forms that may subsequently be redrawn into profiles. Each mold has three different cavities and is available in two sizes.



ITEM #	DESCRIPTION	LENGTH
27-1331	REGULAR	6"
27-1332	EXTRA LONG	9½"

86. Adjustable Ingot Molds

Convert metal scrap into rolling stock. Made of high quality steel. Each mold may be reduced in size by adjusting the sides in a horizontal direction.



ITEM #	L X W X T	DWT
27-1321	50 X 45 X 3.5MM	80
27-1322	70 X 45 X 4.5MM	150
27-1323	100 X 45 X 4.5MM	200
27-1324	135 X 70 X 5.5MM	500

87. Open Ingot Molds

Single or multiple molds in graphite. Molds withstand high temperatures and are used to cast small ingots.

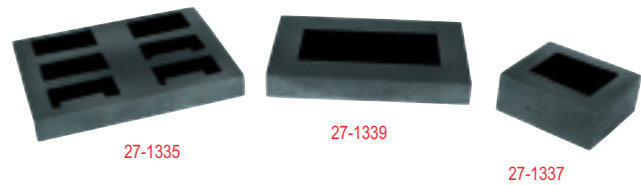

ITEM #	CAPACITY	SIZE	CAVITY
27-1335	1 OZ- 6 CAVITIES	6" X 5" X ¾"	2" X 1¼" X ½"
27-1336	5 OZ	2¼" X 2" X 1"	1¼" X 1" X ½"
27-1337	10 OZ	3" X 2¼" X 1"	2¼" X 1¼" X ½"
27-1338	20 OZ	2¼" X 2" X 1"	1¼" X 1" X ½"
27-1339	1 KG	3" X 2¼" X 1"	2¼" X 1¼" X ½"

88. Graphite Ingot Molds

A one piece forged steel mold to make large ingots from molten scrap.



ITEM #	L X W X T	DWT
27-1341	35 X 90 X 35MM	50
27-1342	30 X 120 X 45MM	80
27-1343	40 X 155 X 65MM	200



CLEANERS

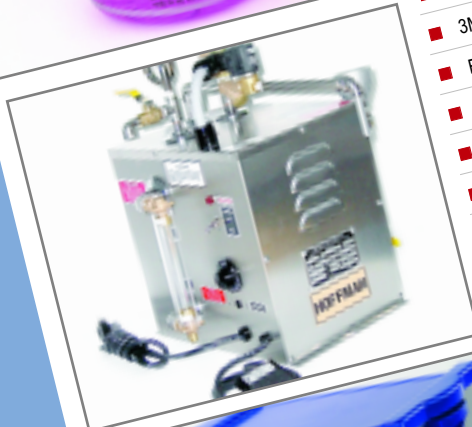

■ 3M® Scotch Brite Cloths	106	■ Plastic Strainer	104
■ 3M® Tarnish Strips & Anti-Tarnish Shield	104	■ Ring Cleaning Racks	104
■ Bar Racks for Ultrasonic Cleaners	104	■ Rouge Cloth	106
■ Brite-CR	105	■ Sambol Jewelry Products	108
■ Connoisseurs Jewelry Cleaners	106, 107	■ Selvyt® Cloths	106
■ Elmasonic E-series	102	■ Speed Brite Ionic Cleaners	103
■ Hoffman® Steam Cleaner	102	■ Stainless Steel Baskets	102
■ Ikohe Mini Cleaner	102	■ Steam Additive	105
■ In Line Ring Rack	104	■ Steamaster	103
■ Jewelry Wipes	106	■ Super Chamois Cloth	106
■ Lint Free Cloths for Precious Stones	106	■ Tivaclean	105
■ "Magic" Luster & Concentrates	105	■ Ultra Concentrate- Pink	105
■ Modular Ultrasonic Racks	104	■ Ultra Sonic Soap-Gold	105
■ Plastic Coated Steam Tweezers	105	■ Umbrella Type Ring Rack	104

 **ikohe**

Elma

SAMBOL

CONNOISSEURS

HOFFMAN

**Techniques of Jewelry
Illustration and Color Rendering**
by **Adolfo Mattiello**

Beautifully illustrated guide to jewelry rendering. Some of the best jewelry designers in the field explain and demonstrate the illustration process.

61-1013 (Hardcover – 152 pages)



CLEANERS



1. Elmasonic E-series

The NEW Elmasonic E series has these latest features for quicker improved cleaning results

- Microprocessor controlled 37khz transducer power, self regulating generator
- Electronic diode display for time and temperature
- Auto-start temperature controlled / temperature selection
- Permanent sweep for an improved cleaning performance
- Brushed stainless steel cavitation resistant tanks with calibrated fill level
- Ceramic heating elements tested and absolutely dry run proof
- Safety switch/off



Capacity: 0.80L / 0.25 gal
 Tank Size: 7 1/2" X 3 1/2" X 2 1/2"
 Dimensions: 8" X 4 1/2" X 7" Wt. 2.2 lbs

ITEM #	MODEL
28-1011	S-10H - 110V / 90W
28-1012	S-10H - 220V / 90W



Capacity: 1.75L / 0.50 gal
 Tank Size: 6" X 5 1/2" X 4"
 Dimensions: 7" X 7 1/2" X 9" Wt. 4.5 lbs

ITEM #	MODEL
28-1013	E-15H - 110V / 90W
28-1014	E-15H - 220V / 90W



Capacity: 2.75L / 0.75 gal
 Tank Size: 9 1/2" X 5 1/2" X 4"
 Dimensions: 12" X 7" X 8 1/2" Wt. 6 lbs

ITEM #	MODEL
28-1015	E-30H - 110V/240W
28-1016	E-30H - 220V/240W



Capacity: 5.75L / 1.50 gal
 Tank Size: 12" X 6" X 6" (with Drain)
 Dimensions: 14 1/2" X 7 1/2" X 10 1/2" Wt. 10 lbs

ITEM #	MODEL
28-1017	E-60H - 110V/500W
28-1018	E-60H - 220V/500W



Capacity: 12.75L / 3.50 gal
 Tank Size: 12" X 9 1/2" X 8" (with Drain)
 Dimensions: 14 1/2" X 11" X 12 1/2" Wt. 15 lbs

ITEM #	MODEL
28-1019	E-120H-110V/600W
28-1020	E-120H-220V/600W



Capacity: 18.00L / 5.00 gal
 Tank Size: 13" X 12" X 8" (with Drain)
 Dimensions: 15 1/2" X 13 1/2" X 12 1/2" Wt. 18 lbs

ITEM #	MODEL
28-1021	E-180H-110V/800W
28-1022	E-180H-220V/800W



Capacity: 28.00L / 7.50 gal
 Tank Size: 20" X 12" X 8" (with Drain)
 Dimensions: 22 1/2" X 13 1/2" X 12 1/2" Wt. 22.5 lbs

ITEM #	MODEL
28-1023	E-300H-110V/1200W
28-1024	E-300H-220V/1200W



2. Baskets for E-sonic Cleaners

These stainless steel baskets make handling of small articles and jewelry easy to immerse while ultrasonic cleaning.



ITEM #	DESCRIPTION
28-1026	BASKET FOR 1.75L / 0.50 gal
28-1027	BASKET FOR 2.75L / 0.75 gal
28-1028	BASKET FOR 5.75L / 1.50 gal

3. Stainless Steel Baskets

Drop and lift off baskets make handling of small articles and jewelry easy to immerse while ultrasonic cleaning.

*Picture not shown

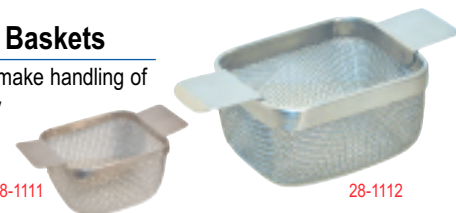

ITEM #	DESCRIPTION	DIMENSIONS
28-1111	S.S BASKET	5 1/4" X 4 3/4" X 2"
28-1112	S.S BASKET	5 1/2" X 5" X 3 1/8"
28-1113*	S.S BASKET	9" X 5" X 3 1/8"
28-1114*	S.S BASKET	11" X 5 3/8" X 5"



4. Speed Brite Ionic Cleaners

A fast cleaning process for jewelry and precious stones, without ultrasonic waves, in less than a minute. This process, called ionic cleaning, uses an electrolyte solution that imparts a brightness to jewelry and a sparkle to precious stones. Environmentally safe, it is a gentle way to clean emeralds, opals, pearls and other soft stones.

Speed Brite Ionic Adapter: Boost the power of your ultrasonic cleaner by the add-on ionic adapter which comes complete with transformer and metal hook for suspension. (UL approved)

Gem Sparkle Cleaning Solution: Specifically formulated solution to remove dirt, grime and oxidation. May be used to clean delicate stones with a soft brush.

ITEM #	SPECIFICATION	CAPACITY
28-1051	110V / 60HZ	12 OZ.- 200SB
28-1052	220V / 50HZ	12 OZ.- 200SB
28-1053	110V / 60HZ	32 OZ.- 309SB
28-1054	220V / 50HZ	32 OZ.- 309SB
28-1055	9V BATTERY	6 OZ.- 100SB
28-1056	ADAPTER #300SB 110V/60HZ	
28-1057	ADAPTER #300SB 220V / 50HZ	
28-1061	GEM SPARKLE 16 OZ. CONCENTRATE	
28-1062	GEM SPARKLE 32 OZ. CONCENTRATE	
28-1063	GEM SPARKLE 1 GAL. CONCENTRATE	

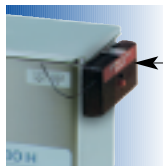

5. Hoffman® Steam Cleaner

Model GEM3: • A portable, versatile and safe steam cleaner
 • Does not have a boiler • Instantly delivers steam at 80-120 psi
 • Water tank can be refilled at anytime, even when unit is hot

Model JEL3: • A technologically superior micronic cleaning system
 • Saves time, boosts productivity • Develops 70-90 psi steam
 • Easy reservoir refill - manual • Adjustable thermostatic controls
 • Fast temperature / pressure recovery • Rust inhibited pressure tank
 • Low maintenance • Finger tip / Solenoid / Foot switch control
 • ASME and UL listed.

ITEM #	SPECIFICATION	CAPACITY
28-1073	110V/60HZ/0.75 KW	GEM-3
28-1074	220V/50HZ/0.75KW	GEM-3
28-1075	110V/60HZ/1.5 KW	JEL3 - 2 GAL.
28-1076	220V/50HZ/1.5KW	JEL4 - 2 GAL.



- Model GEM3**
 • Dimensions: 9" X 11" X 11"
 • Wt. 17lbs
- Model JEL3**
 • Dimensions: 23½" X 17½" X 20½"
 • Wt. 63lbs

6. STEAMASTER® Steam Cleaner

• A compact unit with heavy duty cleaning power • No plumbing required
 • Equipped with a 2 gallon boiler that delivers 70-75 psi pressure
 • Unit includes foot control, stainless release valve and sight glass
 • Conforms to ASME specifications and backed by a warranty
 • Five year warranty on boiler and one year on other parts
 • UL listed

ITEM #	SPECIFICATION	CAPACITY
28-1081	110V/60HZ/1.5KW	2 GAL.
28-1082	220V/50HZ/1.5KW	2 GAL.

- Model HPJ2S**
 • Dimensions: 17" X 7" X 17"
 • Wt. 85lbs





7. Ring Cleaning Racks

Wire formed and vinyl coated to protect rings from abrasion or marring when dipped into the tank for ultrasonic cleaning. Select from different capacities and sizes.

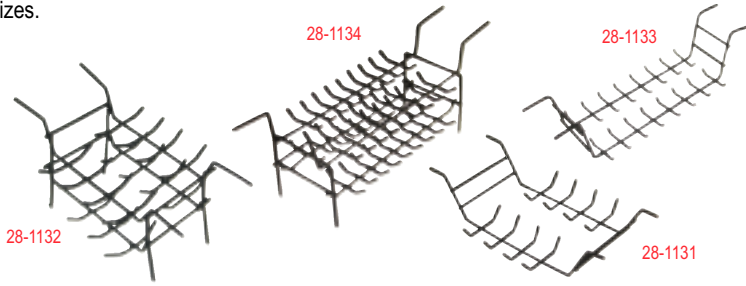

ITEM #	DESCRIPTION
28-1131	5 1/2" X 4" X 1 3/4"-SINGLE 16 RING
28-1132	5 1/2" X 4" X 1 3/4"-DOUBLE 32 RING
28-1133	10" X 4" X 2 1/2"-SINGLE 32 RING
28-1134	10" X 4" X 2 1/2"-DOUBLE 72 RING

8. Umbrella Type Ring Rack

Stainless steel frame plastic coated rack. Hooks are adjustable and evenly spaced to hold articles of jewelry for cleaning or plating.



ITEM #	DESCRIPTION	HOOKS
28-1141	RING RACK	4
28-1142	RING RACK	8
28-1143	RING RACK- JAPAN	20

9. In Line Ring Rack

Wire formed plastic coated cleaning racks with two inch long ring suspension hooks on either side. Available in two sizes. Use on ultrasonic cleaners.



ITEM #	DESCRIPTION
28-1161	6 1/2" LONG WITH 8 HOOKS
28-1162	11" LONG WITH 12 HOOKS

10. Modular Ultrasonic Racks

Heavy duty vinyl coated racks for holding items of jewelry while cleaning ultrasonically. These are provided with an adjustable handle to suit different tank depths. To increase capacity, add-on racks may be snap fitted to the handle. All racks are 8" L x 3" W.



ITEM #	DESCRIPTION
28-1171	RACK WITH 14" HANDLE
28-1172	ADD ON RACK

11. Plastic Strainer

Heavy gauge, plastic strainer with reinforced rim and handle. Available in three sizes.



ITEM #	DESCRIPTION
28-1121	STRAINER 4"
28-1122	STRAINER 5 1/2"
28-1123	STRAINER 7"

12. Bar Racks - for Ultrasonic Cleaners

These bar cleaning racks have molded plastic two sided hooks. Will not mar delicate jewelry. Plastic hooks slide on to the bar and lock in place with end caps. Select a size to suit your ultrasonic cleaner.



ITEM #	DESCRIPTION
28-1151	11 1/2" LONG WITH 8 HOOKS
28-1152	14 1/2" LONG WITH 12 HOOKS
28-1153	REPLACEMENT HOOKS PK/10

13. 3M® Anti-Tarnish Strips & Tarnish Shield

Creative answers shaping cleaner environments

Anti-Tarnish Strips:

- Non-toxic, non abrasive strips
- Protect all precious metals from oxidation
- Absorbs corrosion-causing chemicals from air
- Effectively eliminates tarnish from jewelry
- Inexpensive and easy to use

Tarni Shield:

- Gentle lotion formula, easy and safe to use
- A film coat that protects all precious metals
- No harsh abrasives- won't scratch fine metals
- Does not affect solderability
- Helps avoid discoloration and oxidation



ITEM #	DESCRIPTION
28-1231	ANTI-TARNISH STRIP 2" X 5" - 8 PCS
28-1233	TARNI-SHIELD - SILVER 10 oz



14. Magic Green Powder

A concentrate in powder form that blends well in water. Mix 1-3 oz. to a gal. of water. Fast cleaning action. Biodegradable and non-hazardous.



ITEM #	DESCRIPTION
28-1225	MAGIC GREEN POWDER -32 OZ.
28-1226	MAGIC GREEN POWDER -10 LB.
28-1227	MAGIC GREEN POWDER -50 LB.

15. Magic Luster Concentrate

Four times faster cleaning, a super concentrate that contains no ammonia. Use as an additive for ultrasonic cleaning. Quick cleaning of rouge and tripoli. Mix one part to 40 parts water. Non-hazardous.



ITEM #	DESCRIPTION
28-1211	MAGIC LUSTER CONC. 1 GAL.
28-1212	MAGIC LUSTER CONC. 5 GAL.
28-1213	MAGIC LUSTER CONC. 55 GAL.

16. Tivaclean

- An electro cleaning concentrate for both metals and plastic
- Contains an anti-foaming agent for low sudsing
- Odorless and biodegradable
- Easy to clean with a non-caustic pH of 9-10
- May be used at room temperature
- To enhance its performance, the solution may be heated to a temperature between 160°F-180°F



ITEM #	DESCRIPTION
40-1192	TIVACLEAN 1 LB.

17. Brite-CR

A specially formulated alkaline liquid cleaner for the jewelry industry. Use in an ultrasonic machine for effective removal of grime. Use 2-4 oz. per gallon of water.



ITEM #	DESCRIPTION
28-1237	BRITE-CR - 1 GAL.
28-1238	BRITE-CR - 5 GAL.

18. Ultra Sonic Soap-Gold

Gold in color, this special blend is the standard for jewelers. Effective in removing polishing compounds. Mix one part to 10 parts water. Contains ammonia. Non-hazardous.



ITEM #	DESCRIPTION
28-1221	ULTRA SONIC SOAP GOLD 1 GAL.

19. Ultra Concentrate- Pink

A pink color concentrate used by jewelers and retailers. Works well for cleaning precious metals. Mix one gallon with 10-16 gallons of water. Contains no ammonia. Non-hazardous.



ITEM #	DESCRIPTION
28-1224	ULTRA CONC. PINK 1 GAL.

20. Plastic Coated Steam Tweezers

Coating on tweezer tips provides a non-scratch surface for holding work pieces during steam cleaning. Made of heat resistant stainless steel.

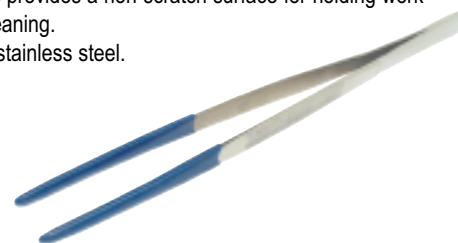

ITEM #	DESCRIPTION	LENGTH
56-1311	STEAM TWEEZERS	8"
56-1312	STEAM TWEEZERS	10"
56-1313	STEAM TWEEZERS	12"

21. Steam Cleaner Additive

A necessary additive for removing rust and mineral deposits in the boiler chamber of steam cleaners. Regular use extends the life of the unit by preventing scale build up.



ITEM #	DESCRIPTION
28-1241	STEAM CLEANER ADDITIVE 16 OZ.



22. Selvyt® Cloths

High quality, long lasting, lint free cloth. Treat with a little polishing rouge then use it to shine jewelry, watches, silverware and crystal.

Sold each

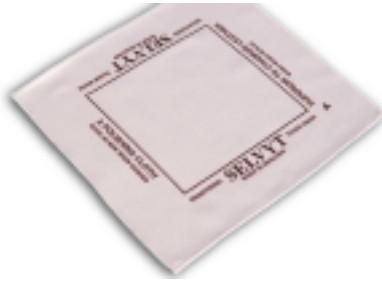

ITEM #	DESCRIPTION	#
42-1141	SELVYT® 5" X 5"	0
42-1142	SELVYT® 10" X 10"	A
42-1143	SELVYT® 14" X 14"	B
42-1144	SELVYT® 14" X 17"	C
42-1145	SELVYT® 17" X 21"	D
42-1146	SELVYT® 20" X 21"	E

23. Selvyt® Cloth-Impregnated

Soft, lint-free, velvet like impregnated cloth. Pre-treated with a polishing agent. Imparts a lasting shine on precious metals.

Sold each



ITEM #	DESCRIPTION
42-1161	SELVYT® 10" X 10" - RED

24. Super Chamois Cloth- Japan

Long lasting chamois imparts an excellent shine to jewelry and a brilliance to precious stones.

Sold each



ITEM #	DESCRIPTION
42-1164	CHAMOIS CLOTH 7" X 4 3/4"

25. Jewelry Wipes

A moist cloth that removes dirt and tarnish from gold, silver and all non-ferrous metals.

Will not scratch or mar the surfaces of fine jewelry. Each dispenser contains 25 dry wipes.

Sold each

CONNOISSEURS



ITEM #	DESCRIPTION
28-1368	#1014 JEWELRY WIPES 25 PCS

26. 3M® Scotch Brite Cloths

A safe and effective cloth that lifts out grease and grime. Durable wipes that can be machine washed in cold water and air dried.

Sold each



ITEM #	SIZE	COLOR
42-1151	12 1/2" X 14 1/2"	WHITE
42-1152	12 1/2" X 14 1/2"	BLUE
42-1153	12 1/2" X 14 1/2"	GREEN
42-1154	12 1/2" X 14 1/2"	YELLOW
42-1155	12 1/2" X 14 1/2"	RED

27. Rouge Cloth

A short nap cloth impregnated with rouge. Soft like velvet. Removes tarnish and fine scratch marks from jewelry.

Sold each

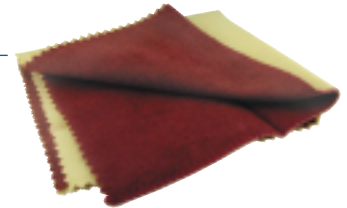

ITEM #	DESCRIPTION
42-1169	ROUGE CLOTH 9" X 11"

28. Lint Free Cloths for Precious Stones

Non-abrasive lint free cleaning cloths, restores luster and brilliance to jewelry and precious stones.

Scratch proof cleaning action is gentle.

White: Pearl

Blue: Diamond

Sold each



ITEM #	DESCRIPTION	SIZE
42-1166	WHITE FOR PEARL	9" X 11"
42-1167	BLUE FOR DIAMOND	9" X 11"

29. Polishing Cloths

Ultrasoft cloth treated with a gentle cleanser. Will remove tarnish and polish silver to a flawless shine.

Sold each

CONNOISSEURS



ITEM #	DESCRIPTION
28-1366	#1012 11" X 14"- FOR GOLD
28-1367	#1013 11" X 14"- FOR SILVER



30. Jewelry Cleaners

28-1351 **New Formula Jewelry Cleaner: 8 oz**

Restores the original shine on gold, diamonds and precious stones.

28-1352 **New Formula Silver Cleaner: 8 oz**

Removes tarnish instantly from silver and sterling silver.

28-1353 **New Formula Delicate Jewelry Cleaner: 8 oz**

Delicate formula for pearls and semi-precious stones.

ITEM #	DESCRIPTION
28-1351	#1045 JEWELRY CLEANER
28-1352	#1046 SILVER CLEANER
28-1353	#1047 DELICATE JEWELRY CLEANER

28-1356 **Sonic Bath:**

- State-of-the art electro-sonic cleaning technology
- Comes with two bath attachment and a clear tank for viewing
- Powered by 4 AAA batteries (not included)

28-1357/28-1358 **Sonic Cleaning Solution: 8 oz.**

- Fast acting, non-abrasive cleaning solution concentrate
- Works best as an additive for ultrasonic cleaning

28-1359 **Jewelry Soap: 5 oz.**

- Non-messy gel, safe for jewelry and gentle for the skin
- Comes with a convenient pump dispenser and cleaning brush

ITEM #	DESCRIPTION
28-1356	#1035 SONIC BATH
28-1357	#1007 SONIC CLEANER FOR PEARLS
28-1358	#1006 SONIC CLEANER FOR GOLD
28-1359	#1032 JEWELRY SOAP

28-1361 **Cleaning Gel & Brush:**

A specially formulated gel to clean diamonds, precious and semi-precious stones, gold and platinum jewelry.

28-1362 **Silver Wipes: (2-6pk)**

Made of an ultrasoft cloth treated with a specially-formulated gentle cleanser. Leaves an anti-tarnish shield that prevents future tarnish build-up.

28-1363 **Silver Polish Paste: 8 oz.**

Cleans silver and controls tarnish build up for months. Comes with a handy applicator sponge.

28-1364 **Silver Polish Liquid: 8 oz.**

A premium product that cleans silver with exclusive tarnish control. Pleasantly scented and rinses quickly.

28-1365 **Metal Polish Liquid: 8 oz.**

An amonia free formula that cleans brass, copper, pewter and chrome. Unique flip top for easy dispensing.

ITEM #	DESCRIPTION
28-1361	#1023 CLEANING GEL & BRUSH
28-1362	#1030 SILVER WIPES (2 -6 PK)
28-1363	#1004 SILVER POLISH PASTE
28-1364	#1002 SILVER POLISH LIQUID
28-1365	#1031 METAL POLISH LIQUID

CONNOISSEURS



28-1359

Ikohe Mini Cleaner

Ideal for retail stores or home use. Efficient solid state circuitry with a three minute auto off timer. Includes plastic basket and cover. Capacity- 600ml. UL and ASME approved.



ITEM #	SPECIFICATION
28-1031	110V / 60 HZ/ 60W
28-1032	220V / 50HZ / 50W





SAMBOL

31. Jewelry Shower

The jewelry shower is a low cost alternative to ultrasonic cleaning. Specifically sensitive for tarnish removal of stone set jewelry. No polishing pastes or toxic fluids. Well suited for soft stones like turquoise, opal, pearls and coral. Unique shower container that allows the solution to flow through. (see illustration)



ITEM #	SPECIFICATION	CAPACITY
28-1411	READY TO USE BOTTLE	200ML
28-1412	REFILL CLEANING SOLUTION	1000ML

SAMBOL



38. Silver Immersion Bath

Particularly suitable for silver articles. The immersion bath will remove stains and tarnish while at the same time protect the surface.

28-1421 150ML #0152



39. Pearl Immersion-Bath

An immersion bath to dip pearl set jewelry. Soft gentle cleansing action will restore the original shine.

28-1424 200ML #0153



40. Pearl Spray Immersion

Genuine cleanser especially for pearls. Shake the solution and spray on the pearls. After a few minutes, rinse in water and dry with a pearl cloth.

28-1425 100ML #0193



41. Precious Metal Polish

Solution to use for cleaning of stone set jewelry. Triple action performance cleans, seals and polishes.

28-1426 100ML #0121



42. Anti-Tarnish Protection ATP100

Effective and long lasting jewelry surface protectant. Prevents tarnish on all precious metals.

Use with a lint free cloth.
28-1427 200ML #0257



43. Piercing Care Products

A disinfecting and cleansing bath prior to piercing. Use the care gel for lubricity during piercing. The ear hole balsam prevents inflammation and promotes healing.

28-1431 EAR HOLE CARE BALSAM
5ML #0015

28-1432 PIERCING CARE GEL
5ML #0025

28-1433 DISINFECTION BATH
125ML #0125



32. Gold Cream-Emulsion

A precious metal polish that reveals an excellent luster in gold crafted or plated jewelry.

28-1414 150ML #0161



33. Silver Cream-Emulsion

Cleans, polishes and protects all silver and plated jewelry. Contains an additive that inhibits tarnish.

28-1415 150ML #0172



34. White Gold / Pt. Immersion-Bath

An immersion bath to cleanse white-gold and platinum. Removes tarnish and maintains an optimized surface protection. Non toxic and safe to use.

28-1416 150ML #0150



35. Yellow Gold Immersion-Bath

A special formulated bath to cleanse yellow gold and gilded jewelry. Lifts tarnish and protects the surface from oxidation. Non toxic and safe to use.

28-1417 150ML #0151



36. Gold Spray Emulsion

An emulsified spray for long term protection of precious jewelry. Effectively seals the surface from oxidation. Safe and gentle to the skin.

28-1418 100ML #0171



37. Silver Spray Emulsion

An excellent spray that cleans and protects silver, silver plated and unfinished jewelry. Leaves a protective anti tarnish coating. Safe and gentle to the skin.

28-1419 100ML #0182



DAPPING TOOLS

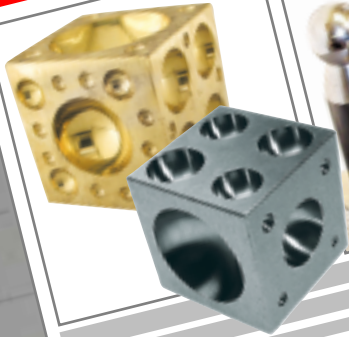

■ Bezel Blocks	113	■ Necklace Mandrel	114
■ Dapping Block-Rubber	110	■ Precision Disc Cutters	113
■ Dapping Block-Brass	110	■ Speciality Dapping Sets-Italy	112
■ Dapping Block-Steel	110	■ Utility Forming and Dapping Blocks	110
■ Dapping Designer Block	110	■ Wood Dapping Block & Punch-Set	114
■ Dapping Punch Set-Deluxe	111	■ Wood Dapping Punches	114
■ Dapping Punch Sets	111		
■ Dapping Punches & Block	113		
■ Deluxe Disc Cutters	110		
■ Flat Dapping Block	110		
■ Forming Block	110		
■ Knuckling Block	110		
■ Master Dapping Sets-Italy	112		

 **ikohe**



All you need to know about metalsmithing is here!!!
Silversmithing and Art Metal
 For Schools, Tradesmen, Craftsmen
 (Revised Edition)
 by **Murray Bovin**; Revised by **Peter M. Bovin**

An excellent project-oriented book for silversmiths. Contains the latest metal techniques including forming, constructing and decorating. **61-1015 (Soft cover-176 pages)**



1. Dapping Block-Brass

Highly polished, tempered brass with hemispheres on all six sides.



ITEM #	DESCRIPTION	SIZE
29-1011	BRASS D/BLOCK	2" X 2" X 2"
29-1012	BRASS D/BLOCK	2 1/2" X 2 1/2" X 2 1/2"

2. Dapping Block-Steel

Alloy steel cube with eighteen polished depressions on all six sides. The 2" cube has its largest hemisphere at 1 3/8". The 2 1/2" cube has a maximum hemisphere at 1 3/4".

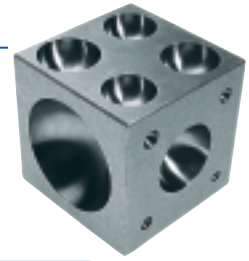

ITEM #	DESCRIPTION	SIZE
29-1014	STEEL D/BLOCK	2" X 2" X 2"
29-1015	STEEL D/BLOCK	2 1/2" X 2 1/2" X 2 1/2"

3. Utility Forming and Dapping Blocks

High quality polished steel anvils. Ideal for bending and grooving

29-1018 : Forming Block - 9 grooves- 3 lbs

29-1019 : Dapping Block - 20 hemisphere - 3 lbs



ITEM #	DESCRIPTION	SIZE
29-1018	FORMING BLOCK	110 X 110 X 75MM
29-1019	DAPPING BLOCK	110 X 110 X 95MM

4. Flat Dapping Block

Made of alloy steel, hardened and polished.

29-1021: 14 hemispheres:

25, 22, 20, 19, 17, 16, 14, 13, 11, 9, 7.5, 5.5, 4.5 and 3mm.

29-1022: 27 hemispheres:

1.5, 2, 2.4, 2.8, 3.2, 3.6, 4.4, 4.8, 5.6, 6.4, 7.1, 7.9, 8.7, 9.5, 10.7, 11.1, 12.7, 14.3, 15.5, 15.9, 17.1, 17.5, 19.1, 20.6, 22.2, 23.8 and 25.4mm (1/8"-1").

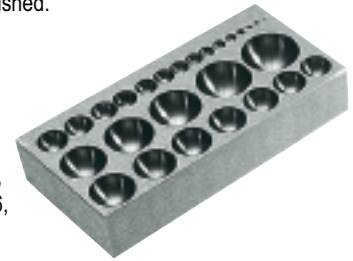

ITEM #	DESCRIPTION	SIZE
29-1021	FLAT D/BLOCK-14	5" X 2 1/2" X 1"
29-1022	FLAT D/BLOCK-27	5" X 2 1/2" X 2"

5. Forming Block

High quality, hardened, polished steel block which can be used on both sides. Eleven semi-circular grooves for bending and shaping.



ITEM #	DESCRIPTION	SIZE
29-1024	FORMING BLOCK	4" X 2" X 1"

6. Dapping Designer Block

A versatile, hardened and polished steel dapping block with working surfaces on six sides. Fourteen hemispherical depressions from 1/8" to 1". Eight semi-circular forms (1/4" to 1").



ITEM #	DESCRIPTION	SIZE
29-1026	DESIGNER BLOCK	3 3/4" X 2 1/2" X 1"

7. Dapping Block- Rubber

Resilient rubber dapping block for use with steel or wood punches. Useful for creating all types of shallow forms and channels in soft precious metals. Will not mar or leave scratches.

Wt. 1 lb

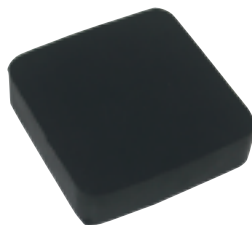

ITEM #	DESCRIPTION	SIZE
29-1031	RUBBER BLOCK	4" X 4" X 1"

8. Knuckling Block

Made of solid polished hardened steel.

This unique block is designed with an assortment of half-round, triangular and channel grooves.

Ideal for bending, grooving and shaping.

Wt. 5 lbs.

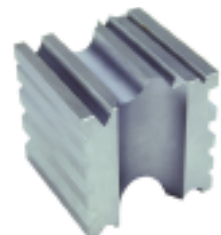

ITEM #	DESCRIPTION	SIZE
29-1028	KNUCKLING BLOCK	2 1/2" X 2 1/2"



9. Dapping Punch Set - Deluxe

Premium quality hardened steel dapping punch set neatly organized on a laminated hardwood stand. Each punch is precision made and highly polished.

24 Punches: ($\frac{1}{64}$ " , $\frac{1}{8}$ " , $\frac{9}{64}$ " , $\frac{5}{32}$ " , $\frac{7}{32}$ " , $\frac{1}{4}$ " , $\frac{9}{32}$ " , $\frac{5}{16}$ " , $\frac{3}{8}$ " , $\frac{13}{32}$ " , $\frac{7}{16}$ " , $\frac{15}{32}$ " , $\frac{1}{2}$ " , $\frac{9}{16}$ " , $\frac{19}{32}$ " , $\frac{5}{8}$ " , $\frac{11}{16}$ " , $\frac{23}{32}$ " , $\frac{3}{4}$ " , $\frac{25}{32}$ " , $\frac{13}{16}$ " , $\frac{7}{8}$ " , $\frac{15}{16}$ " , 1")

ITEM #	DESCRIPTION
29-1040	COMPLETE SET- 24 PCS



10. Individual Dapping Punches

Made of hard tempered steel with mirror finished ball ends. A long support stem with a full hemispherical head provides stability when forming or chasing.



All you need to know about metalsmithing is here!!!

by Tim McCreight

A handy bench reference that clearly explains shaping, forging, raising, mechanisms, casting and reticulation. This easy-to-use book describes everything from the use of tools to metals and their properties. **61-1017**



ITEM #	SIZE	ITEM #	SIZE	ITEM #	SIZE	ITEM #	SIZE
29-1041	$\frac{7}{64}$ "	29-1050	$\frac{5}{16}$ "	29-1059	$\frac{17}{32}$ "	29-1068	$\frac{25}{32}$ "
29-1042	$\frac{1}{8}$ "	29-1051	$\frac{21}{64}$ "	29-1060	$\frac{9}{16}$ "	29-1069	$\frac{13}{16}$ "
29-1043	$\frac{9}{64}$ "	29-1052	$\frac{11}{32}$ "	29-1061	$\frac{19}{32}$ "	29-1070	$\frac{27}{32}$ "
29-1044	$\frac{5}{32}$ "	29-1053	$\frac{3}{8}$ "	29-1062	$\frac{5}{8}$ "	29-1071	$\frac{55}{64}$ "
29-1045	$\frac{11}{64}$ "	29-1054	$\frac{13}{32}$ "	29-1063	$\frac{41}{64}$ "	29-1072	$\frac{7}{8}$ "
29-1046	$\frac{3}{16}$ "	29-1055	$\frac{7}{16}$ "	29-1064	$\frac{21}{32}$ "	29-1073	$\frac{29}{32}$ "
29-1047	$\frac{7}{32}$ "	29-1056	$\frac{15}{32}$ "	29-1065	$\frac{11}{16}$ "	29-1074	$\frac{15}{16}$ "
29-1048	$\frac{1}{4}$ "	29-1057	$\frac{31}{64}$ "	29-1066	$\frac{23}{32}$ "	29-1075	$\frac{31}{32}$ "
29-1049	$\frac{9}{32}$ "	29-1058	$\frac{1}{2}$ "	29-1067	$\frac{3}{4}$ "	29-1076	1"

11. Dapping Punch Sets

Highly polished sets of dapping punches made of hardened alloy steel.

29-1081~29-1083 : Deluxe Dapping Punch Set

29-1087~29-1089 : Value Dapping Punch Set



ITEM #	DESCRIPTION	QTY	SIZE
29-1081	DELUXE PUNCHES	18	$\frac{7}{64}$ " - $\frac{3}{4}$ "
29-1082	DELUXE PUNCHES	24	$\frac{7}{64}$ " - 1"
29-1083	DELUXE PUNCHES	36	$\frac{7}{64}$ " - 1"
29-1087	VALUE PUNCHES	18	$\frac{7}{64}$ " - $\frac{3}{4}$ "
29-1088	VALUE PUNCHES	24	$\frac{7}{64}$ " - 1"
29-1089	VALUE PUNCHES	36	$\frac{7}{64}$ " - 1"

12. Dapping Punches & Block

Large six sided dapping block and matched punches.

Made of hardened alloy steel and mirror finished.

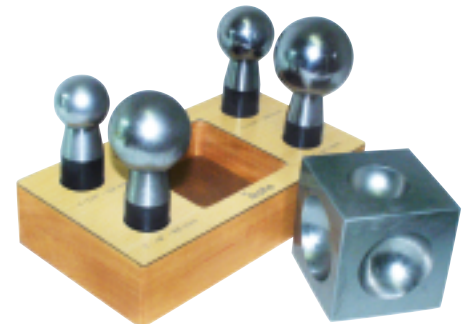

ITEM #	DESCRIPTION
29-1091	COMPLETE SET(PUNCHES 32, 38, 45, 51MM & BLOCK)
29-1092	*PUNCHES 32, 38, 45, 51 W/STAND
29-1093	DAPPING BLOCK - 2 $\frac{1}{2}$ "

*PUNCHES 32, 38, 45, 51 AVAILABLE ON ORDER.



Master Dapping Sets- Italy

Premium quality dapping and punch sets all made in Italy. Machined to precision tolerances in tool alloy steel, each punch is hardened, tempered, ground and polished to a mirror finish. It is the highly polished surface that guarantees that the metal being shaped will not have any streaks or flaws. All sets are supplied with a polished wooden base to store each individual punch and block.

13. Matched Set - Block with 21 Punches 4-54MM

Punches:
4, 5, 6, 7, 9, 10, 11, 12, 15, 16, 17, 18,
22, 24, 28, 30, 37, 39, 44, 49, 54
Block : 78 x 78MM
Wood Base: 195 x 195MM
Wt. 23 lbs



ITEM #	DESCRIPTION
29-1111	BLOCK WITH 21 PUNCHES

14. Matched Set - Block with 24 Punches-2-25MM

Punches:
2, 3, 4, 5, 6, 7, 8, 9, 10, 11, 12, 13, 14,
15, 16, 17, 18, 19, 20, 21, 22, 23, 24, 25
Wood Base: 195 x 195MM
Block : 70 x 70MM
Wt. 18 lbs



ITEM #	DESCRIPTION
29-1112	BLOCK WITH WITH 24 PUNCHES

15. Matched Set - Block with 31 Punches- 2-32MM

Punches:
2, 3, 4, 5, 6, 7, 8, 9, 10, 11, 12, 13, 14,
15, 16, 17, 18, 19, 20, 21, 22, 23, 24, 25,
26, 27, 28, 29, 30, 31, 32
Wood Base: 265 x 160MM
Block: 180 x 150MM
Wt. 30 lbs



ITEM #	DESCRIPTION
29-1113	BLOCK WITH WITH 31 PUNCHES

Speciality Dapping Sets- Italy

A unique collection of speciality dapping sets. Create the most fascinating forms in metalsmithing. All matched sets. Made of the finest steel, hardened and polished to exacting standards. Each punch and the master block neatly mounted on a polished wooden base marked with the corresponding size.

16. Matched Set - Block with 4 Oval Punches

Punches:
oval 18-26-34-41
Block: 16 depressions
Wt. 12 lbs



ITEM #	DESCRIPTION
29-1114	BLOCK WITH WITH 4 PUNCHES

17. Matched Set - Half Round Block with 12 Punches-2-32MM

Punches:
2.75, 3.70, 4.75, 5.85, 6.70, 7.80, 8.85,
9.85, 11.90, 14.85, 19.85, 24.85
Wood Base: 265 x 160MM
Block: 180 x 150MM
Wt. 30 lbs



ITEM #	DESCRIPTION
29-1115	BLOCK WITH WITH 12 PUNCHES

18. Matched Set - Knuckling Block with 14 Punches-4-32mm

Punches:
3 SQ. Corner Punches, 3 Angled
Punches, 1 Knuckling Block
Wt. 8 lbs

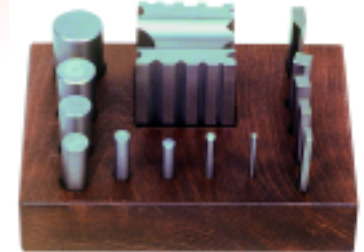

ITEM #	DESCRIPTION
29-1116	BLOCK WITH WITH 14 PUNCHES



19. Precision Disc Cutters

High grade tool steel, hardened and tempered. Cuts perfect discs in gold, silver or soft metals. Use manually or on a hydraulic press.



ITEM #	DESCRIPTION	SIZE
29-1121	2 PCS SET -3 LBS	1 1/4" X 1 1/2"
29-1122	5 PCS SET -3 LBS	1/2" X 1" (1/16" INCR)
29-1123	7 PCS SET -2 LBS	1/8" X 1/2" (1/16" INCR)

20. Deluxe Disc Cutters

Designed for jewelers to precision cut discs to close tolerances. Hardened tool steel with perfect shear edges. Works well on precious and soft metals up to 18 swg.



ITEM #	DESCRIPTION	SIZE
29-1126	18 PCS SET- 6 LBS	3 TO 14MM
29-1127	8 PCS SET - 6 LBS	15 TO 22MM

21. Bezel Blocks and Punch Sets

A complete selection of the most used shapes of bezel blocks. Precision machined hardened and tempered steel. The punch is matched in angle and profile to its bezel block.

Create the bezel forms you need in a range of calibrated sizes.

Range 4-14 4 lbs
Range 5-20 8 lbs
Range 14-21 8 lbs



MAKE A PERFECT BEZEL

Use a disc cutter to make a washer

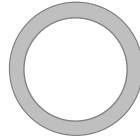

Select a bezel punch and block to form a bezel

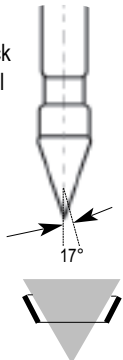

ITEM #	PROFILE	SHAPE	RANGE	PUNCH
29-1131	■	EMERALD	4 to 14mm	17°
29-1132	●	ROUND	5 to 20mm	17°
29-1133	●	OCTAGON	4 to 14mm	17°
29-1134	▲	TRIANGLE	4 to 14mm	17°
29-1135	●	OVAL	4 to 14mm	17°
29-1136	◐	HALF-RND	5 to 15mm	17°
29-1137	⬡	HEXAGON	4 to 14mm	17°
29-1138	◐	PEAR	4 to 14mm	17°
29-1139	■	SQUARE	4 to 14mm	17°
29-1140	♥	HEART	4 to 15mm	17°
29-1141	♥	HEART	14 to 21mm	17°



Note: Bezel blocks and punches of special shapes and sizes are available on order.



22. Wood Dapping Block & Punch-Set

Hardwood block, smoothly finished, has shallow concave depressions on all six sides. Comes in a set with two punches. Use for repair and removing dents.

Wt. 1 lb



ITEM #	DESCRIPTION	SIZE
29-1151	W/DAPPING SET	2½" X 2½" X 2½"

23. Wood Dapping Punches

Well polished carefully handcrafted hardwood dapping punches.

Diameters are 7-20mm by 1mm and 20-40mm by 2 mm.

Set of 24 pcs.

Wt. 2 lbs



ITEM #	DESCRIPTION	SIZE
29-1152	PUNCHES SET OF 24 PCS	

24. Wood Dapping Block

Extra large hardwood dapping block has two hemispheres and four half round grooves. Use for forming large domed or grooved shapes.

Wt. 4 lbs



ITEM #	DESCRIPTION	SIZE
29-1153	W/DAPPING BLOCK	7" X 7" X 3¾"



Daps and dapping blocks may be made of metal or wood.

A wooden dapping block is less expensive than a metal dapping block. Wooden dapping blocks have shallow depressions and some blocks have multiple depressions.

A dap is a domed hand tool used to form metal shapes in the depressions of a dapping block.

A dapping block may be a rectangular block or a cube that has depressions that match the dap.



Forming of metal in dapping blocks is usually done in thin gauges and in soft metal. Use a hammer or a mallet for dapping. For Hammers and Mallets see page # 184

Working Block

A working block and a stake is an essential tool for almost every silversmith. See pg# 186



26. Necklace Mandrel

Highly polished cast iron and chrome plated necklace mandrel. Shape and form metal or wax directly on the mandrel.

Wt.6 lbs



ITEM #	DESCRIPTION	SIZE
29-1161	N/MANDREL	8" X 7¼" X 5½"

25. Wood Dapping Punch & Block-Set

Large wood dapping block and punch set has eight hemispheres and matched punches. Diameters are 17, 25, 31, 35, 47, 59, 68 and 90mm. Will not mar metal when shaping and forming.

Wt. 4 lbs



ITEM #	DESCRIPTION	SIZE
29-1154	W/DAPPING BLOCK	11¾" X 7" X 3"



DIAMOND TOOLS

- Adjustable Shoulder Wallet 126
- Aluminum Boxes 127
- "Beeper Style" Wallet 128
- Color Posters 125
- CZ Master Sets 128
- Designer Diamond Display Box 129
- Diamond Coated Drills 130
- Diamond Disc Set 129
- Diamond Fly Wheels 122, 123
- Diamond Gauges 130
- Diamond Points 128
- Diamond Replicas 127
- Diamond Scoops 125
- Diamond Scribe 123
- Diamond Sellers 116
- Diamond Sieve Sets 117
- Diamond Sorting Pad 124, 125
- Diamond Testers 130
- Diamond Texturing Tool 129
- Diamond Tools- Single Point 118
- Diamond Tweezers 126
- Diamond Vest- for Dealers 127
- Diamond Washing Cups 120
- Display Rings 126
- Gem Parcel Boxes 129
- Girdle MicroGauge

- Hearts & Arrows Sales Aid 120
- Large Stone Profile System 129
- Leather Wallets 127
- Loupes 120
- Meleemeeter Gauge 128
- Micromat Gauge 122
- Moissanite* Tester 125
- Parcel Papers 117
- Pearl & Stone Dial Gauges 122
- Prong Holder 119
- Scales 121
- Sorting Trays 127
- Starlight- Diamond Tweezers 119
- Stone Depth Estimator 129

- Table MicroGauge 129
- Titanium Super Sieve Sets 116
- Titanium Diamond Tweezers 119
- Tray for Diamond Sieves 116
- Wax Stick for Gem Stones 119











Straight Talk on Diamonds
 An invaluable reference guide with detailed explanation on the 4C's of diamonds. Includes photographs, diagrams and a CD. Useful for sales personnel at jewelry stores.
 61-1238



L. DAVID®

Sieve sets are not returnable



3. Tray for Diamond Sieves

An organizer to hold sieve plates for easy viewing. Clearly marked locations store each sieve separately. Sieves not included.

Sold each



ITEM #	DESCRIPTION
30-1091	PLASTIC- SIEVE TRAY
30-1092	CLEAR ACRYLIC SIEVE TRAY

1. Diamond Super Sieve Sets

Top quality sieves made in Belgium. Precision drilled holes with latest technology. Engineered to the highest industry specifications. Comes with sieve plate numbers and mm sizes in a stainless steel container.

Sieve Plates

ITEM #	DESCRIPTION	PLATES	Ø
30-1011	000-20 BY HALF SIZES	42	80MM
30-1012	0000-20 BY QUARTER SIZES	74	80MM
30-1013	0000-12 BY EIGHTH SIZES	79	80MM

Super sieve sets with additional sizes

30-1017	000-12 BY EIGHTH SIZES 13-15 BY QUARTER SIZES 16-20 BY HALF SIZES	101	80MM
30-1018	0000-12 BY EIGHTH SIZES 13-15 BY QUARTER SIZES 16-20 BY HALF SIZES *	125	80MM

* Includes additional sizes as given below

Sieve Plates in MM

42 Plates: 000 to 20 by half- sizes

74 Plates: 0000 to 20 by quarter sizes

79 Plates: 0000 to 12 by eighth sizes

101 Plates: 0000 to 12 by eighth sizes, up to 15 in quarter sizes, up to 20 by half sizes

125 Plates: 0.60, 0.625, 0.65, 0.675, 0.70, 0.725, 0.75, 0.775, 0.825, 0.875, 0.925, 0.975, 102.5, 107.5 + from 0000 to 12 by eighth sizes, up to 15 in quarter sizes, up to 20 by half sizes + 355, 365, 375, 385, 395, 405, 415, 425, 435, 445

2. Antwerp Diamond Sieve Sets

Long lasting sieves to sort diamonds and other precious stones. Sets are complete in four different diameters and come in a sealed durable container.

Sets in Half Numbers- Antwerp

ITEM #	DESCRIPTION	PLATES	Ø
30-1061	0-20 IN HALF NUMBERS	41	48MM
30-1062	0-20 IN HALF NUMBERS	41	66MM
30-1063	0-20 IN HALF NUMBERS	41	80MM
30-1064	0-20 IN HALF NUMBERS	41	107MM

4. Diamond Sieve Sets- Value

Long lasting sieves to sort diamonds and other precious stones. Sets are complete in four different diameters and come in a sealed durable container.

Full & Half Numbers

ITEM #	DESCRIPTION	PLATES	Ø
30-1071	000-20 IN FULL NUMBERS	23	48MM
30-1072	000-20 IN FULL NUMBERS	23	66MM
30-1073	000-20 IN FULL NUMBERS	23	80MM
30-1074	000-20 IN FULL NUMBERS	23	107MM
30-1081	000-20 IN HALF NUMBERS	42	48MM
30-1082	000-20 IN HALF NUMBERS	42	66MM
30-1083	000-20 IN HALF NUMBERS	42	80MM
30-1084	000-20 IN HALF NUMBERS	42	107MM



5. Parcel Papers

Choice selected papers, polished to perfection. Unmatched for protection. Created to enhance gems with reflected light. Select from different flute colors for every situation.

ITEM #	STONE	OUTSIDE/PAPER	INSIDE/FLUTES	#
Rubin Diamond Parcel Paper-  - Pk/100				
30-1111	DIAMOND	1-BLUE 1-WHITE	NIBUR R1	1
30-1112	DIAMOND	2-DK. BLUE	NIBUR R3	1
30-1113	DIAMOND	2-WHITE	NIBUR 2	1
30-1115	DIAMOND	1-BLUE 1-WHITE	DIVAD-BL	1
30-1116	DIAMOND	2-BLUE	DIVAD-BD	1
30-1117	DIAMOND	2-WHITE	DIVAD-W	1
LDavid Diamond Premium Parcel Paper - Pk/100				
30-1121	DIAMOND	1- BLUE 1-WHITE	DLP 1	1
30-1122	DIAMOND	1- BLUE 1-WHITE	DLP 2	2
30-1123	DIAMOND	2 BLUE	DRR1	1
30-1124	DIAMOND	2 BLUE	DRR2	2
30-1125	DIAMOND	2 BLUE	DX 1	1
30-1126	DIAMOND	2 BLUE	DX 2	2



Value Diamond Parcel Paper- Pk/25				
30-1131	DIAMOND	2-WHITE	3 3/4" X 2"	2
30-1132	DIAMOND	2-WHITE	4" X 2"	3
30-1133	DIAMOND	2-WHITE	5" X 3"	4

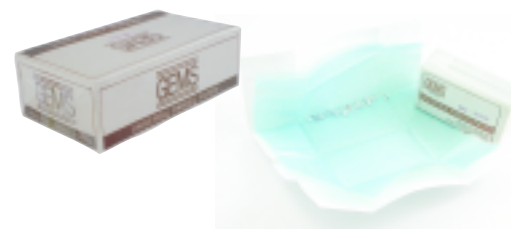

Value Diamond Parcel Paper- Pk/100				
30-1141	DIAMOND	2-WHITE		1
30-1142	DIAMOND	2-BLUE		1
30-1143	DIAMOND	1 BLUE 1-WHITE		1

Value Parcel Paper- Color Gemstone- Pk/100				
30-1151	RUBY	2-YELLOW		1
30-1152	EMERALD	2-TAN		1
30-1153	OPAL	2-BLACK		1
30-1154	SAPPHIRE	2-MATTE WHITE		1



Value Diamond Flutes- Pk/500				
30-1161	DIAMOND	BRIGHT WHITE	2-WHITE	1"
30-1162	DIAMOND	BRIGHT WHITE	2-WHITE	3/4"
30-1163	DIAMOND	BLUE	2-WHITE	3/4"
30-1164	DIAMOND	BLUE	2-WHITE	1"



6. Diamond Sorting Pad

- Extra firm sorting pad with a non-reflective flat surface
- A practical method to sort large quantities of gemstones
- Saves time-consuming scooping and ensures broad based viewing for selection

ITEM #	DESCRIPTION	SIZE
30-1181	70 SHEETS -DELUXE	9" X 13"
30-1182	70 SHEETS -DELUXE	11" X 17"
30-1183	70 SHEETS -DELUXE	12" X 20"
30-1184	70 SHEETS -DELUXE	17" X 22"
30-1188	70 SHEETS -VALUE	11" X 17"
30-1189	70 SHEETS -VALUE	12" X 20"

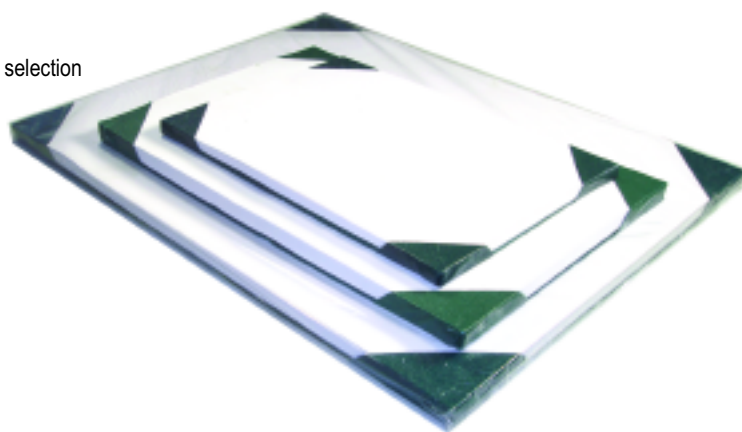



7. Diamond Tweezers

Absolutely the best and the finest made tweezers specifically for the professional jeweler. Select from a wide range of stainless matte or black finish. Inside grooved or serrated tips, with or without a locking mechanism. Overall length 160mm.

			ITEM #	TYPE
	MATTE FINISH	REGULAR	56-1011	XF
			56-1012	F
			56-1013	M
			56-1014	L
			56-1015	XL
	BLACK	REGULAR	56-1021	XF
			56-1022	F
			56-1023	M
			56-1024	L
			56-1025	XL
	MATTE FINISH	LOCK	56-1032	FR
			56-1033	MR
			56-1034	LR
			56-1035	XLR
	BLACK	LOCK	56-1042	FR
			56-1043	MR
			56-1044	LR
			56-1045	XLR
	MATTE FINISH	GROOVED	56-1053	M1
			56-1054	L1
			56-1055	XL1
			56-1056	XXL1
	BLACK	GROOVED	56-1063	M1
			56-1064	L1
			56-1065	XL1
			56-1066	XXL1
	MATTE FINISH	LOCK - GROOVED	56-1073	MR1
			56-1074	LR1
			56-1075	XLR1
	BLACK	LOCK - GROOVED	56-1083	MR1
			56-1084	LR1



DIAMOND TOOLS & SUPPLIES

8. Starlight- Diamond Tweezers

Starlight tweezers have a fine granulated coating which firmly holds small or large stones at any angle. Starlight titanium tweezers are lighter than Starlight diamond tweezers, yet twice as strong. Overall length 160mm.

XF	EXTRA FINE	0.4	FR	FINE LOCK	0.6	M1	MEDIUM GROOVED	0.9
F	FINE	0.6	MR	MEDIUM LOCK	0.9	L1	LARGE GROOVED	1.2
M	MEDIUM	0.9	LR	LARGE LOCK	1.2	XL1	X-LARGE GROOVED	1.8
L	LARGE	1.2	XLR	EXTRA LARGE	1.8	XXL1	XX-LARGE GROOVED	2.4
XL	EXTRA LARGE	1.8	MR1	MEDIUM GRVED. LOCK	0.9			
			LR1	LARGE GRVED. LOCK	1.2			
			XLR1	X-LARGE GRVED. LOCK	1.8			



ITEM #	TYPE
56-1111	XF
56-1112	F
56-1113	M
56-1114	L
56-1115	XL
56-1122	FR
56-1123	MR
56-1124	LR

Titanium Tweezers

Super lightweight rust resistant tweezers, excellent for sorting and inspecting stones. 100% non-magnetic. Overall length 160mm.

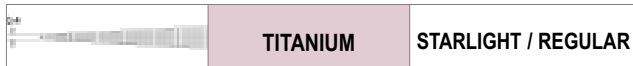

STARLIGHT		REGULAR	
ITEM #	TYPE	ITEM #	TYPE
56-1141	XF	56-1131	XF
56-1142	F	56-1132	F
56-1143	M	56-1133	M
56-1144	L	56-1134	L
56-1145	XL		

9. Teflon Tweezers- Swiss

Top quality Swiss tweezers with teflon coated tips, particularly good for showing diamonds and handling precious gems. Length 6 1/2".

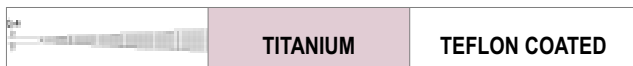

ITEM #	TYPE
56-1181	TEFLON

For a complete range of Tweezers see page # 308

10. Wax Stick for Gem Stones

Ideal for lifting loose stones, without smudge or stain, and positioning them in the stone seats. Cones are tapered to a point and mounted on a handle.

Sold bx/12



ITEM #	DESCRIPTION
30-1191	WAX STICK

11. Prong Holder

Ideal for holding precious and semi-precious stones for inspection and valuation.



ITEM #	DESCRIPTION
30-1194	PRONG HOLDER -4 3/4"
30-1195	PRONG HOLDER -2"



12. Eschenbach Precision Loupes

- A folding magnifier made of fiberglass and reinforced polyimide
- Sealed construction protects loupe from dust particles
- Aplanatic lens provides a distortion free image
- Color corrected lens to eliminate optical distortion

Achromatic: Crystal-clear optics with no color aberration.

Aplanatic: Two plano-convex glass lenses offer distortion-free, superior optics throughout the viewing field. Focal Length 1".



ITEM #	POWER	FOCAL	LENS Ø
39-1351	3X+ 6X	ACHROMATIC	23MM
39-1352	10X	APLANATIC	23MM

14. H. Schneider® Jewelers Loupe

A world renowned professional jewelers loupe. Unsurpassed high quality viewing through a three lens system. The aplanatic-achromatic design provides a view that is distortion free from every angle.



ITEM #	POWER	FOCAL	LENS Ø
39-1366	10X	1"	21MM

16. B & L® Hastings Triplet Loupe

A Hastings lens has three lenses bonded together to form a compound lens. View sharp magnified images with no color distortion.



ITEM #	POWER	FOCAL	LENS Ø
39-1272	10X	1"	15.8MM
39-1273	14X	¾"	12.5MM
39-1274	20X	½"	8.25MM

18. Hearts & Arrows Sales Aid

A powerful sales aid to view the ideal cut of a brilliant diamond. When viewed, the pavilion of a perfectly cut stone will show a symmetrical pattern of hearts and arrows.

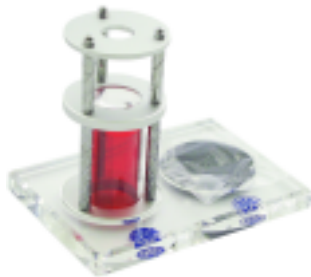

ITEM #	DESCRIPTION
30-1261	HEARTS & ARROWS

13. Nikon Professional Loupe

A rare combination of peerless clarity and unrivaled optical quality from the world leader in optics. Compound lenses deliver a distinct magnified image with no color distortion. Images are as sharp at the edges as at the center.



ITEM #	POWER	FOCAL	LENS Ø
39-1361	10X	1"	19.75MM

15. Zeiss Professional Loupe

Pocket magnifier for the professional. The aplanatic and achromatic design of the Zeiss lens system provides a field of view that is free of chromatic aberrations and distortion in the peripheral zone. The anti-reflective coating prevents glare.



ITEM #	POWER	FOCAL	LENS Ø
39-1356	6X	1"	22MM
39-1357	3X + 6X	1"	22MM
39-1358	10X	1"	19.75MM

17. Gems 10X Triplet Loupe-Hex

Four models are available. Each has a large, clear, tintless round glass lens. Working distance 1". Comes with leather pouch.



ITEM #	TYPE	LENS Ø
39-1311	BLACK	21MM
39-1312	CHROME	21MM
39-1313	GOLD	21MM
39-1314	RUBBER	21MM

19. Display Rings

Use for displaying precious color stones. Squeeze shank sides together and prongs slide apart to hold the stone.



ITEM #	DESCRIPTION
30-1271	CHROME SMALL < 2 CTS.
30-1272	CHROME LARGE > 2 CTS.
30-1273	GOLD SMALL < 2 CTS.
30-1274	GOLD LARGE > 2 CTS.



DIAMOND TOOLS & SUPPLIES



20. Carat Scales- Legal for trade

METTLER TOLEDO offers an outstanding range of carat balances for weighing precious stones. JB-C/FACT balances provide additional security - no matter the conditions.



JB-C / FACT



- /F - FACT Included
- C - Carat
- Fully Automatic Calibration Technology.**

- Back-lit display • RS232-C interface • Carat pan & protective cover
- Fully Automatic adjustment with internal weight
- Dimensions : 245 X 321 X 280 MM
- The JB-L-C balances are identical to the JB-C/FACT balances except they have an external calibration. The calibration weight is included

JB-C / FACT- JEWELRY PLUS						Modes: ct, g, ozt, dwt
MODEL	110V	CAPACITY	READABILITY	REPEATABILITY	LINEARITY	WEIGHING PAN
JB703-C/A-F	47-1151	700CT / 140G	0.001CT/0.001G	0.001CT/0.001G	0.001CT/0.001G	Ø 80MM
JB1203-C/A-F	47-1153	1200CT / 240G	0.001CT/0.001G	0.001CT/0.001G	0.001CT/0.001G	Ø 80MM
JB1603-C/A-F	47-1154	1600CT / 320G	0.001CT/0.001G	0.001CT/0.001G	0.001CT/0.001G	Ø 80MM
JB703-L-C/A	47-1161	700CT / 140G	0.001CT/0.001G	0.001CT/0.001G	0.001CT/0.001G	Ø 80MM
JB1203-L-C/A	47-1163	1200CT / 240G	0.001CT/0.001G	0.001CT/0.001G	0.001CT/0.001G	Ø 80MM
JB1603-L-C/A	47-1165	1600CT / 320G	0.001CT/0.001G	0.001CT/0.001G	0.001CT/0.001G	Ø 80MM

21. JL-C- Legal for trade

JL-C balances save space, are functional and ideal for sales with a second display. *You can be sure that your balance is on spec at all times!*



- C - Carat

- Back-lit display • RS232-C interface
- RS232-C interface for second display • Carat pan & protective cover
- Adjusting weights • All models with external adjustment
- Dimensions : 194 X 225 X 174 MM

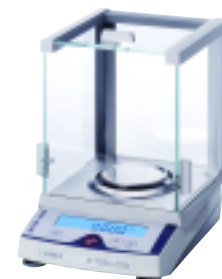

JL-C- JEWELRY LIGHT						Modes: ct, g, ozt, dwt
MODEL	110V	CAPACITY	READABILITY	REPEATABILITY	LINEARITY	WEIGHING PAN
JL502-C/A	47-1155	510CT / 102G	0.01CT/0.01G	0.01CT/0.01G	0.01CT/0.01G	Ø 100MM
JL603-C/A	47-1156	610CT / 122G	0.001CT/0.001G	0.001CT/0.001G	0.001CT/0.001G	Ø 80MM
JL1103-C/A	47-1157	1100CT / 220G	0.001CT/0.001G	0.001CT/0.001G	0.001CT/0.001G	Ø 80MM
JL1503-C/A	47-1159	1510CT / 302G	0.001CT/0.001G	0.001CT/0.001G	0.002CT/0.001G	Ø 80MM

22. Sartorius® Carat Scales- GD Series

Carat and Gold scales that combine ease of operation with precise, ultra-fast results.

- Large blue backlit display for easy viewing • Extra large weighing pans
- RS232C connection for immediate print out proof on an optional printer
- Features all international weights used in the jewelry trade • CE approved

ITEM #	47-1311
MODEL	*GD603
CAPACITY	605 ct
READABILITY	0.001ct
CALIBRATION	100g (included)
DIMENSIONS	7.9" X 9.9" X 9.2"
PAN SIZE	Ø 3.1"



Triangular shaped weighing pan
 Ø= diameter of inner circle.
 Extra area offers 27% more space

For more scales see page # 249

* GD series: Battery pack optional





23. Micromat Leveridge Type Gauge -USA

The most versatile measuring instrument for any jewelry appraiser or gem cutter. Estimates weight of diamonds mounted or loose. May also be used for other precious gems and pearls. Comes with high setting attachment and weight estimator. Includes an inside measuring system for rings. Precision crafted for years of service.



ITEM #	DESCRIPTION
35-1141	MICROMAT LEVERIDGE TYPE GAUGE
35-1142	BOOK & CASE

25. Quick Mini Digital Gauge- Japan

An ingenious measuring device designed and crafted to the most exacting standards. Lightweight, ergonomic body, with large measuring faces, useful for both thick and thin parts. Clear digital readout with a maximum reading of 25mm/1" and a resolution of 0.01mm/ 0.0005".



ITEM #	DESCRIPTION
35-1151	QUICK MINI 0-25MM (Battery included)

27. Pearl & Stone Dial Gauges

A sensitive, precision engineered dial gauge for accurate measurements of pearls and other small stones. Parallel ground measuring faces for rounds and baguettes in 0.1mm increments. Dial rotates for absolute zero setting.

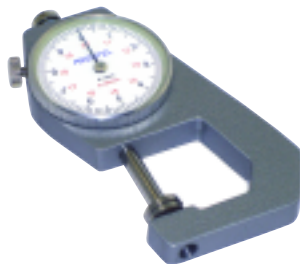

ITEM #	DESCRIPTION	CAPACITY
35-1161	S/DIAL GAUGE-GERMANY	10MM
35-1162	S/DIAL GAUGE-GERMANY	20MM
35-1165	S/DIAL GAUGE-VALUE	10MM
35-1166	S/DIAL GAUGE-VALUE	20MM

24. Presidium® Gauges

Presidium® Dial Gauge:

Predictable accuracy. Read out measurement in millimeters and weight in carats simultaneously. Measures stones up to 23 mm in divisions of 0.1mm. Hardened wear resistant measuring surfaces.

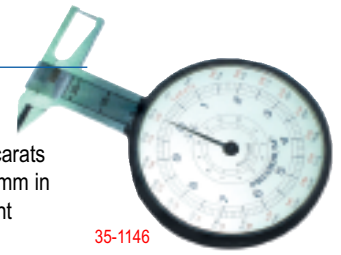

35-1146

Includes a conversion booklet and case.

Presidium® Gem Computer Gauge:

Estimate the weight of gemstones with precision and speed, 0.01mm resolution. Direct carat conversion for round brilliant cut diamond. Covers 132 gemstones in nine different shapes. Retrieve the specific gravity from the SG dictionary just by entering the name of the stone.



35-1148

ITEM #	DESCRIPTION
35-1146	DIAL GAUGE 0-23MM
35-1147*	DIGITAL GEM STONE GAUGE 0-23MM
35-1148	GEM COMPUTER GAUGE 0-25MM

* see page 168 for details

26. C-Master Jewelry Gauge- Japan

A compact, highly accurate digital gauge for easy stone measurement. The unit is provided with a twin gauge head that measures both inside and outside. Features automatic calculation of caratage. Measures from melee to taper with maximum reading of 25mm/1" .



ITEM #	DESCRIPTION
35-1155	C-MASTER 0-25MM (Battery included)

28. Stone Millimeter Dial Gauges

A well designed gauge that provides an easy measuring system for single hand operation. Precision parallel measuring faces for rounds and baguettes in 0.1mm increments up to a maximum of 10mm. Dial rotates for absolute zero setting.



ITEM #	DESCRIPTION
35-1168	MILLIMETER DIAL GAUGE 0.1-10MM

For Gauges
see page # 165



DIAMOND TOOLS & SUPPLIES

VIBE-130

29. Compact Diamond Scale

A Diamond Scale in the palm of your hand.

- Unique lightweight ultra precision scale • Easy to hold and operate
- Displays diameter and weight in less than three seconds
- Maximum diameter up to 8mm
- Weighs from 0.005 to 1.2 carats with an accuracy within four to five microns
- Exclusive PC software
- Bluetooth technology
- Transfers data to your company's computerized inventory or spreadsheet
- Saves time and eliminates errors



BREAKTHROUGH TECHNOLOGY

Diameter and weight in a split second
Exact caratage in any shape



ITEM #	DESCRIPTION
35-1135	DIAMOND SCALE VIBE-130

30. Fan Type Diamond Gauge

Compact, fan type, pocket gauge in stainless steel. Measures in carat weight all stone cuts in brilliant, marquise, pear, square, emerald and oval. Overall length 3 1/2".



ITEM #	DESCRIPTION	CARAT
35-1061	3 ARMS ROUND FRANCE	0.1 TO 4
35-1062	4 ARMS ROUND FRANCE	0.1 TO 6
35-1063	7 ARMS ASSORTED USA	0.1 TO 8

31. Sliding Gauges- Germany

Convenient pocket sized sliding gauges in alloy and brass. Clear machine marked graduations. Useful for quick outside measurements (in/mm) of small parts or stones.

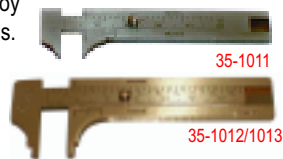

ITEM #	DESCRIPTION
35-1011	ALLOY 50MM
35-1012	BRASS 60MM
35-1013	BRASS 80MM

32. Jo-Di Gauge

Unique international sizing system. Measures diameter and width of four basic shapes: round, marquise, emerald and pear. High contrast black anodized scale readings are to be compared with the reference booklet. Comes in a handy wallet.



ITEM #	DESCRIPTION
35-1068	JO-DI GAUGE

33. Accurate Diamond Gauge

Pocket sized, aluminum gauge, provides the comparative size of gemstones in carats. Size range is 1 point to 2.1 carats. For size estimates of round, brilliant cuts and baguettes.



ITEM #	DESCRIPTION
35-1041	ACCURATE GAUGE

34. Diamond Gauge- France

Polished steel gauge, in either oval or rectangular shape. Determines the carat weight of loose or mounted stones, from 1 point to 4 carats. Marked sizes for easy reading.

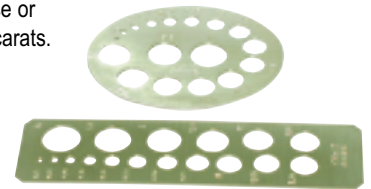

ITEM #	DESCRIPTION
35-1047	5 CM -OVAL
35-1048	9 X 205 CM -RECTANGLE

35. Diamond Sellers

Exhibit the brilliance of precious gemstones in an eye catching display. Safe, secure and a more efficient way to reveal the shapes of emerald, oval, pear, square, round and marquise.



ITEM #	DESCRIPTION
30-1197	7 DIAMOND ARMS - MIX CUTS
30-1198	10 DIAMOND ARMS - ROUND



54-1131



54-1132



54-1133



54-1134



54-1135



54-1136

36. PRESIDIUM Diamond Testers

Professional, compact, sleek penlike instrument. Digital electronic circuitry consistently and reliably distinguishes between diamonds and simulant. Gives an audible continuous-beep when diamond is tested. Comes in a vinyl pouch.

Diamond Mate-A: Operates on alkaline AAA batteries
May be used with AC adapter. Batteries not included

Diamond Mate-C: Operates on rechargeable NICAD batteries
May be used with AC adapter. Batteries not included

37. PRESIDIUM Moissanite Tester:

Distinguishes diamond from moissanite. A reliable hand held tester to identify synthetic moissanite by capacitive measurement. A special polymer grade probe gives an instantaneous reading. This tester is recommended for use after a positive testing result for diamond with a conductivity tester. Operates on 3 (AAA) alkaline batteries (not included).

Multi Tester: *The multi-tester distinguishes diamond from CZ and moissanite* by the combined principle of thermal and electrical conductivity from patented technology. A micro-processor processes the data and displays the results in seconds. Features include a retractable probe that ensures accurate and consistent pressure, LED display and low battery indicator. Operates on 3 (AAA) alkaline batteries (not included).

ITEM #	DESCRIPTION	DIMENSIONS
54-1131	DIAMOND MATE - A	160 X 30 X 20.5MM
54-1132	DIAMOND MATE - C	160 X 30 X 20.5MM
54-1133	MOISSANITE TESTER	160 X 21 X 30MM
54-1134	MULTI TESTER	160 X 42 X 22MM
54-1130	110/220V AC ADAPTER (OPTIONAL)	

38. PRESIDIUM Diamond Fact

A professional top of the line tester. Instantly separates simulant from the genuine. Small compact pocket model has needle tip testing point for stones as small as 0.02 carat. Operates on two AAA batteries (not included).

Distinguishes Diamond from CZ but not Moissanite

ITEM #	DESCRIPTION	DIMENSIONS
54-1135	DIAMOND FACT	92 X 22 X 68MM

39. PRESIDIUM Gem Tester

Comes in a vinyl pouch. The gem tester instantly separates diamond from all known simulants. The design of the gem tester is based on thermal conductivity. A probe measures the rate of heat being conducted away from the stone. The gem tester can be used on mounted and unmounted stones as small as 0.02 carat. Comes complete with AC adapter in a velvet lined box. Also operates on two AA batteries (not included).

Distinguishes Diamond from simulated stones.

ITEM #	DESCRIPTION	DIMENSIONS
54-1136	GEM TESTER	180 X 96 X 72MM



DIAMOND TOOLS & SUPPLIES

40. Culti Diamond Testers

Improved positive sensing distinguishes the look alike from the genuine. A very reliable tester that identifies natural diamond from white corundum, Y.A.G. and other simulants. Advanced electronic display. Supported by manufacturer's warranty.

*IC chip built-in for pin point accuracy
Genuine diamond indicated by a red light and beep
Moissanite cannot be distinguished by these testers
Two AAA alkaline batteries, loose stone holder and case are included*

ITEM #	DESCRIPTION
54-1121	DIAMOND TESTER CULTI 111 -JAPAN
54-1122	DIAMOND TESTER -VALUE



41. MIZER Diamond Testers-USA

Fast, sensitive and reliable. Delivers result in seconds. Tests even the smallest gemstones. Negligible warm up time, automatic shut off and audible diamond signal. Supported by manufacturer's warranty.

*12 light linear display to identify diamonds, CZ and other stones.
Metal alert alarm and audible diamond signal.
Operates on one 9V alkaline battery*

ITEM #	DESCRIPTION
54-1139	DIAMOND TESTER - (Battery included)



42. IKOHE Moissanite* Tester

The revolutionary new tester that outsmarts and even detects moissanite, which is a simulant for diamond. Ultra sensitive, can check stones of 0.01 carat or less. Readings displayed on both sides allowing use in either hand. Backed by manufacturer's warranty.

Separates synthetic moissanite from diamonds after testing with a conventional diamond tester. Flashing green light indicates that stone is moissanite or synthetic. Operates on one 9V alkaline battery

ITEM #	DESCRIPTION
54-1137	MOISSANITE TESTER - (Battery included)



** Moissanite is a stone available as natural or synthetic. It is similar to diamond in color, hardness and thermal conductivity. Using a moissanite tester will ensure your diamond is not a simulant.*

43. Diamond Scribe

A slim finely pointed scribe for layout work. Will mark glass, stone, ceramic and all precious metals. Diamond tip is retractable for protection.

ITEM #	DESCRIPTION
54-1141	DIAMOND SCRIBE



44. CZ Master Sets

Hand graded by master craftsmen for precision color accuracy against G.I.A. master diamonds. All CZ masters in the set fall within the required world standards. Each set has a five year manufacturer's warranty against color change. All CZ's are 0.80ct.-1.0ct. diamond equivalent.

ITEM #	DESCRIPTION
30-1201	5- STONE SET (D, F, H, J & L)
30-1202	5- STONE SET (E, G, I, K & M)
30-1203	10- STONE SET (D, E, F, G, H, I, J, K, L & N)
30-1218	COLOR GRADING PAPER (PK/25)

CZ master sets are not returnable



Individual CZ color graded stones are available.



45. Gem Parcel Boxes

Features black simulated leather cover with adjustable partitions to store precious gems. Interior is lined with soft velvet and includes an elastic band to prevent displacement of parcels. Parcel papers are not included.



ITEM #	DIMENSIONS
30-1301	4" X 6 1/8" X 2 3/4"
30-1302	4" X 11 1/8" X 2 3/4"

47. Gem Parcel Cases with Adjustable Partitions

Unique black simulated leather covered boxes with adjustable partitions and satin-lined interiors. Features a combination lock for security. Parcel papers are not included.



ITEM #	DIMENSIONS
30-1321	4 3/4" X 7 1/4" X 2 1/2"
30-1322	4 3/8" X 11" X 2 1/2"

49. Diamond Vest- for Dealers

Extra durable navy blue vest with two zippered pouches and two open pockets. Fits over shoulders with pouches, one on each side, and anchors with an adjustable strap to suit all sizes.



ITEM #	DESCRIPTION	SIZE
30-1361	DIAMOND VEST	20" X 11 3/4"

46. Security Wear for Diamond Dealers

Exquisitely handcrafted, well designed to conceal and carry up to 24 diamond parcel papers. Specially created for diamond dealers. This innovative new concept will revolutionize the way precious gems are transported and presented to potential clients. The belt can be adjusted according to your measurement.



ITEM #	DESCRIPTION
30-1311	BELT TYPE
30-1312	LEG TYPE

48. Blue Foam Boxes

A safe and secure way to display, store or ship precious stones. Attractive blue foam cushion to showcase the gems. Available in two sizes.

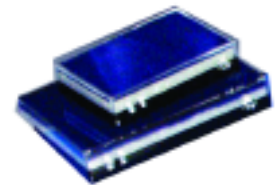

ITEM #	DIMENSIONS
30-1331	1 1/2" X 2 1/2"
30-1332	2 1/2" X 3 1/2"

50. Adjustable Shoulder Wallet

A discreet shoulder pouch made of the finest nylon. Two zippered pockets to store precious gems and valuables. Adjustable shoulder strap for added comfort.



ITEM #	DESCRIPTION	SIZE
30-1359	SHOULDER WALLET	8" X 7 1/2"



DIAMOND TOOLS & SUPPLIES

51. Aluminum Box for Parcel Paper

High quality lightweight aluminum boxes for storage of parcel papers. Split hinged top with velvet interiors and partitions.



ITEM #	DIMENSIONS
30-1326	7 1/4" X 4" X 3"
30-1327	11 3/4" X 4" X 3"

53. Value Leather Wallets

Use these slim style wallets made of durable leather to carry precious gemstones. Wallets have ample space to carry gemstones in parcel paper and have a zipper.



ITEM #	DIMENSIONS
30-1354	8" X 3 3/4" X 3/4"

55. Flat Leather Wallets

A sleek slim line zipper leather wallet. Fits in your diamond vest or attaches to your belt with a wallet chain.

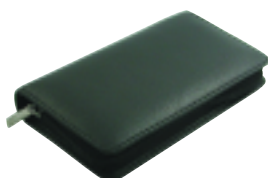

ITEM #	DIMENSIONS
30-1357	6" X 3 1/2" X 1/2"
30-1358	7" X 3 1/2" X 2"

57. Diamond Washing Cups

- Rinse and clean diamond and precious gemstones
- Stainless steel inner container easily lifts out of glass jar
- A screw cap prevents evaporation of cleansing liquid



ITEM #	DESCRIPTION
30-1228	WASHING CUP 2 1/2" X 2 1/2"

52. "Beeper Style" Wallet

An ideal wallet in a convenient size that holds your precious parcels of gems. The wallet has a plastic zipper and clips that will not activate most metal detectors.



ITEM #	DIMENSIONS
30-1351	7" X 4" X 3/4"

54. Diamond Scoops

Handle all stones in a time saving manner. Made of non-magnetic stainless steel. Select from a range of sizes to suit your convenience.



ITEM #	DESCRIPTION	SIZE
30-1221	SCOOP W/HANDLE	2 3/4" x 2 1/8"
30-1222	SCOOP SS #2	2" X 1 1/4"
30-1223	SCOOP SS #3	2 1/2" X 2"
30-1224	SCOOP SS #4	3" X 2"
30-1225	SCOOP SS #5	3 1/2" X 2 1/2"

56. Sorting Trays

- Trays are made of unbreakable plastic
- Provides a functional way to sort all loose gemstones
- Four grooves on one side and specific hole sizes on the other
- Available in two colors

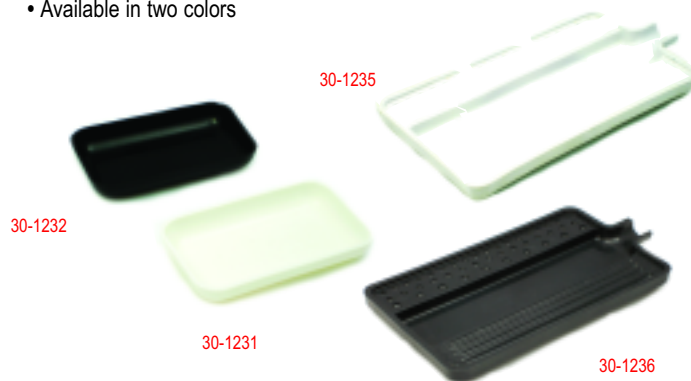

ITEM #	DESCRIPTION	SIZE
30-1231	WHITE TRAY	4" X 2 1/2"
30-1232	BLACK TRAY	4" X 2 1/2"
30-1235	WHITE TRAY-GROOVED	7 1/8" X 3 3/4"
30-1236	BLACK TRAY-GROOVED	7 1/8" X 3 3/4"

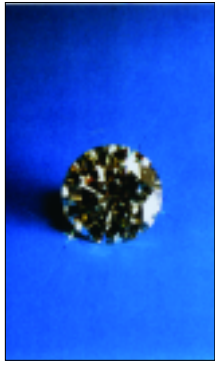

P101



P102

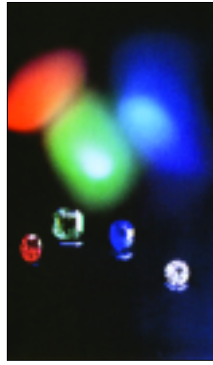

P103



P106

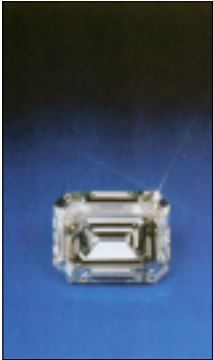

P107

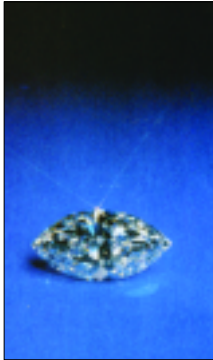

P108

59. Diamond Replicas

Brilliant diamond replicas for showcases will enhance and create the perfect setting for displaying jewelry. Top quality full cut 58 facet crystal in three sizes.



30-1253

30-1252

30-1251

ITEM #	SIZE
30-1251	40 MM (1.6")
30-1252	50 MM (2")
30-1253	60 MM (2.3")

61. Designer Diamond Display Box

An elegant way to display loose diamonds. The diamond is secured in a black foam cushion with a clear lid that snaps shut.



ITEM #	SIZE
30-1256	3" X 1 1/2" X 1/2"

58. Full Color Posters

High quality diamond posters on fine art paper are in full color. This superb collection of full color posters is ideal for placing in shop or store windows.



P104

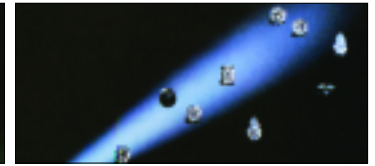

P105

ITEM #	POSTER #	SIZE
30-1281	P101	25 1/2" x 37 1/4"
30-1282	P102	25 1/2" x 37 1/4"
30-1283	P103	25 1/2" x 37 1/4"
30-1284	P104	25 1/2" x 37 1/4"
30-1285	P105	25 1/2" x 37 1/4"
30-1286	P106	25 1/2" x 37 1/4"
30-1287	P107	25 1/2" x 37 1/4"
30-1288	P108	25 1/2" x 37 1/4"

60. Straight Talk on Diamonds

An invaluable reference guide with detailed explanation on the 4C's of diamonds. Includes photographs, diagrams and a CD. Useful for sales personnel at jewelry stores.



ITEM #	DESCRIPTION
61-1238	BOOK/CD BY BARRY ELLIN

62. Meleemeeter Gauge

A business card sized gauge for non-accessible measurements on stones. A set consists of 10 transparent plastic cards with a total of 590 different sizes and shapes of melee and larger stones. Matching the profiles eliminates the need to measure and compute weights.

The set comes in a brushed brass case.

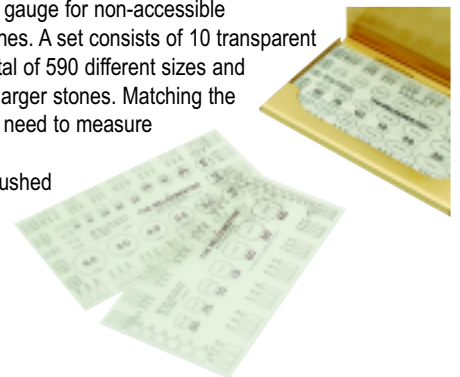

ITEM #	DESCRIPTION
35-1171	MELEEMEETER GAUGE SET

Made of flexible, transparent plastic.



DIAMOND TOOLS & SUPPLIES

63. Diamond Fly Wheels

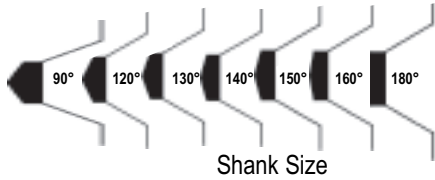

Use these fly wheels on rotary handpieces to fashion brilliant patterns on jewelry. Tools have a natural diamond point. Speed min. 30,000 rpm.

DEGREE	3MM	4MM
90°	30-1401	30-1411
120°	30-1402	30-1412
130°	30-1403	30-1413
140°	30-1404	30-1414
150°	30-1405	30-1415
160°	30-1406	30-1416
180°	30-1407	30-1417



65. Diamond Coated Drills

These electroplated twist drills are excellent for drilling stones, pearls, glass or ceramics. Drills are all medium grit. Shank size 3/8". Lubricate with water during use. **Sold each**

SIZE	ITEM #
1.0MM	30-1471
1.1MM	30-1472
1.2MM	30-1473
1.3MM	30-1474
1.4MM	30-1475
1.5MM	30-1476
1.6MM	30-1477
1.8MM	30-1478
2.0MM	30-1479



67. Girdle MicroGauge

A business card size gauge designed to measure surfaces not accessible with a micrometer to 0.01 accuracy. It is unsurpassed for gauging girdles, cutlets or flaws.



ITEM #	DESCRIPTION
35-1172	GIRDLE MICROGAUGE- 3 1/2" X 1 1/8"

Made of flexible, transparent plastic.

69. Table MicroGauge

Designed to measure a gemstone table from 1 to 10mm when used with a 7- 10X loupe. It can measure to an accuracy of 0.01mm and is the size of a business card.



ITEM #	DESCRIPTION
35-1173	TABLE MICRO GAUGE - 3 1/2" X 1 1/8"

Made of flexible, transparent plastic.

64. Diamond Tools- Single Point

Single point diamond cutting tool in a steel shank for use in faceting machines. Different styles and novel designs may be cut with these special styled tools.



DEGREE	3MM	DEGREE	3MM
110°	30-1421	145°	30-1427
120°	30-1422	150°	30-1428
125°	30-1423	155°	30-1429
130°	30-1424	160°	30-1430
135°	30-1425	165°	30-1431
140°	30-1426	180°	30-1432

66. Large Stone Profile System

A professional set of 12 rules consisting of a total of 168 size and ratio outlines of all popular gemstone shapes. Bold outlines and accurate facets make visualizing easy.



ITEM #	LENGTH
35-1175	STONE PROFILE SYSTEM

Made of flexible, transparent plastic.

68. Stone Depth Estimator

The Estimator is a scan gauge which measures the inaccessible depth of mounted stones. Used with low magnification, an accuracy of 0.02mm can be achieved.



ITEM #	DESCRIPTION
35-1174	STONE DEPTH ESTIMATOR-3 1/2" X 1 1/8"

Made of flexible, transparent plastic.

70. Leveridge Gauge Estimator

A true time saver. This gauge enables you to measure round melee with higher accuracy without the book's tables. May be used with new or old American/European gauges.



ITEM #	DESCRIPTION
35-1176	LEVERIDGE GAUGE ADD ON 1 1/2" X 3/4"

Made of flexible, transparent plastic.



71. Diamond Points

Premium quality diamond particles are electroplated on stainless steel shanks. Diamond points are excellent for carving, smoothing and performing numerous tasks in stone, glass, ceramics and all non-ferrous metals. Use of a water based coolant will maximize tool life. Recommended speed is 30,000 rpm. Shank size $\frac{3}{32}$ ".

Sold each.

ITEM #		SIZE
30-2601		A. 2.5 X 7 MM
30-2602		B. 3 X 7 MM
30-2603		C. 1.5 X 10 MM
30-2604		D. 5 X 10 MM
30-2605		E. 5 X 12 MM
30-2606		F. 2.5 X 10 MM
30-2607		G. 1.5 X 10 MM
30-2608		H. 1.5 X 4 MM
30-2609		I. 5 X 2 MM
30-2610		J. 4 X 1.5 MM
30-2611		K. 2.7 X 1.5 MM
30-2612		L. 2 X 1.5 MM

ITEM #		SIZE
30-2613		M. 3.5 X 6 MM
30-2614		N. 2 X 5 MM
30-2615		O. 2 X 10 MM
30-2616		P. 2.5 X 7 MM
30-2617		Q. 5 X 10 MM
30-2618		R. 1.5 X 5 MM
30-2619		S. 2 X 7 MM
30-2620		T. 1 X 1 MM
30-2621		U. 2 X 2 MM
30-2622		V. 3 X 3 MM
30-2623		W. 4 X 4 MM
30-2624		X. 2.7 X 1 MM

72. Diamond Point Sets

Set of 12 points in a plastic pouch.
Shank size $\frac{3}{32}$ ".

Set A: consists of #A-L

Set B: consists of #M-X



ITEM #	DESCRIPTION
30-2631	SET A - #A-L 12 PCS
30-2632	SET B - #M-X 12 PCS

74. Diamond Texturing Tool

These single point diamond tools are for use on a Badeco hammer handpiece or similar. Shanks are screw on type with tapered points for working in intricate areas.



ITEM #	DESCRIPTION
30-2641	STANDARD
30-2642	LASER POINT- DELUXE

76. Diamond Disc Set -Value

These diamond discs are electroplated and ideal for cutting or sanding stones and glass. Kit comes with $\frac{1}{8}$ " mandrel. Disc will also fit standard mandrel with $\frac{3}{32}$ " shank.



ITEM #	DESCRIPTION
30-2651	5 PCS SET WITH MANDREL

73. Diamond Point Assorted Shapes

A complete set of electroplated diamond points on stainless steel shanks, in various shapes. Gives a super smooth finish on stone, glass, ceramic and all precious metals.

Recommended operating speed is 30,000 rpm.

Shank size $\frac{3}{32}$ ".

Set A: consists of 20 pcs

Set B: consists of 30 pcs

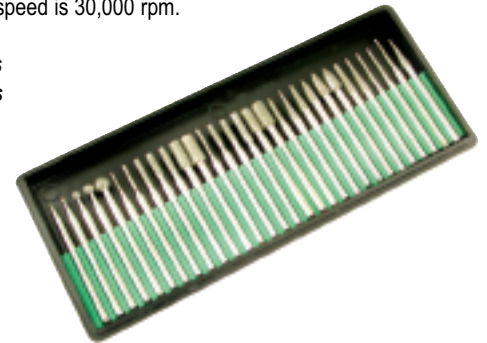

ITEM #	DESCRIPTION
30-2635	SET A- 20 PCS
30-2636	SET B- 30 PCS

75. Diamond Separating Discs #355 - Swiss

Super fine diamond discs designed for cutting metals, shanks, prongs etc.

Sold each

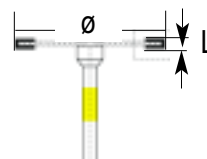

ITEM #	30-1355	30-1356
Ø X L	19 X 0.12MM	22 X 0.12MM
SPEED	20,000 RPM	15,000 RPM
SHANK SIZE	$\frac{3}{32}$ "	$\frac{3}{32}$ "

Diamond separating discs are not returnable.



DRILLS

E



■ Drill Gauges	133	■ Mini Bench Drill Machine	134
■ Drill Press	134	■ Pearl Drill Set	133
■ Hand Drill - German	133	■ Pearl Drilling Machine	133
■ High Speed Twist Drill- Set 61-80	132	■ Pearl Drill Bits	133
■ High Speed Twist Drills	132	■ Pearl Holding Vise	133
■ Jeweler's HSS Twist Drills- #203	132	■ Poseidon Lathe	134
■ Jeweler's Twist Drills	132		
■ Jeweler's Twist Drills - Set	132		

Jewelry Making Manual

by **Sylvia Wicks**

An excellent introduction to metalsmithing covering a wide range of techniques. Covers hand-fabricating, enameling, engraving, repoussé and chasing, plus a section on jewelry illustration. 300 illustrations, more than 150 in full color, makes complex techniques understandable.

61-1121 (Hardcover – 176 pages)

 **Ikohe**



DORMER



DRILLS



1. Jeweler's Twist Drills- Vanadium Steel

Superior quality vanadium steel twist drills ground to precision tolerances. All with 3/32" shanks. Use bur lube when drilling for cool cutting and lubrication.

Bx/6.



SIZE	ITEM #	MM(Ø)	ISO	INCH
5/0	31-1005	0.50	005	0.0197
4/0	31-1006	0.60	006	0.0236
3/0	31-1007	0.70	007	0.0276
2/0	31-1008	0.80	008	0.0315
0	31-1009	0.90	009	0.0354
1	31-1010	1.00	010	0.0393
2	31-1011	1.10	011	0.0441
3	31-1012	1.20	012	0.0472
4	31-1013	1.30	013	0.0500
5	31-1014	1.40	014	0.0512
6	31-1015	1.50	015	0.0591
7	31-1016	1.60	016	0.0630
8	31-1017	1.70	017	0.0689
9	31-1018	1.80	018	0.0709
10	31-1019	1.90	019	0.0748
11	31-1020	2.00	020	0.0787
12	31-1021	2.10	021	0.0827
13	31-1022	2.20	022	0.0866
14	31-1023	2.30	023	0.0906

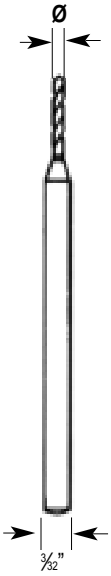

3. Twist Drills- High Speed

Dormer Drills: High speed bright finish jewelers drills with super sharp cutting edges. Precision ground to close tolerances. Recommended for use on hard metals.

Ikohe Drills: High speed jewelers drills in bright finish with precision cutting edges. Use in hand held flexshafts, electric mini drills and light bench drills.

Bx/10

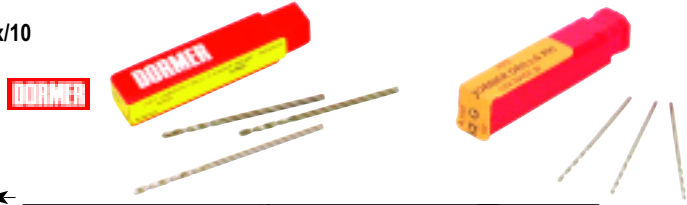

SIZE	MM(Ø)	INCH	DORMER	IKOHE
50	1.78	0.0700	31-1150	31-1250
51	1.70	0.0670	31-1151	31-1251
52	1.61	0.0635	31-1152	31-1252
53	1.51	0.0595	31-1153	31-1253
54	1.40	0.0550	31-1154	31-1254
55	1.32	0.0520	31-1155	31-1255
56	1.18	0.0465	31-1156	31-1256
57	1.05	0.0430	31-1157	31-1257
58	1.07	0.0420	31-1158	31-1258
59	1.04	0.0410	31-1159	31-1259
60	1.02	0.0400	31-1160	31-1260
61	1.00	0.0390	31-1161	31-1261
62	0.97	0.0380	31-1162	31-1262
63	0.94	0.0370	31-1163	31-1263
64	0.91	0.0360	31-1164	31-1264
65	0.89	0.0350	31-1165	31-1265
66	0.84	0.0330	31-1166	31-1266
67	0.81	0.0320	31-1167	31-1267
68	0.79	0.0310	31-1168	31-1268
69	0.74	0.0293	31-1169	31-1269
70	0.71	0.0280	31-1170	31-1270
71	0.66	0.0260	31-1171	31-1271
72	0.64	0.0250	31-1172	31-1272
73	0.61	0.0240	31-1173	31-1273
74	0.57	0.0225	31-1174	31-1274
75	0.53	0.0210	31-1175	31-1275
76	0.51	0.0200	31-1176	31-1276
77	0.46	0.0180	31-1177	31-1277
78	0.41	0.0160	31-1178	31-1278
79	0.37	0.0145	31-1179	31-1279
80	0.34	0.0135	31-1180	31-1280

for chuck adapters see Page# 159

2. Jeweler's Twist Drills

Ultra high precision ground drills in carbide and HSS with 3/32" shanks. Bx/6



MM(Ø)	ISO	INCH	T-CARBIDE	HSS
			TC-MD58	HSS-203
0.50	005	0.0197	31-1025	31-1125
0.60	006	0.0236	31-1026	31-1126
0.70	007	0.0276	31-1027	31-1127
0.80	008	0.0315	31-1028	31-1128
0.90	009	0.0354	31-1029	31-1129
1.00	010	0.0393	31-1030	31-1130
1.10	011	0.0441	31-1031	31-1131
1.20	012	0.0472	31-1032	31-1132
1.30	013	0.0500	31-1033	31-1133
1.40	014	0.0512	31-1034	31-1134
1.50	015	0.0591	31-1035	31-1135
1.60	016	0.0630	31-1036	31-1136
1.70	017	0.0689	31-1037	31-1137
1.80	018	0.0709	31-1038	31-1138
1.90	019	0.0748	31-1039	31-1139
2.00	020	0.0787	31-1040	31-1140
2.10	021	0.0827	31-1041	31-1141
2.20	022	0.0866	31-1042	31-1142
2.30	023	0.0906	31-1043	31-1143

4. Jeweler's Twist Drills - Set

Set of 12 twist drills in a plastic pouch. Drills have 3/32" shanks. Size ISO-005 to 016 (0.05 to 1.60 mm)



ITEM #	DESCRIPTION
31-1046	SET OF 12 TWIST DRILLS



5. Pearl Drilling Machine

Ultra sensitive drill in an aluminum housing, specifically designed to drill pearls from 3 to 7mm diameter without any chipping or cracking. Unit is compact with a motor, drill chuck and self centering vise to automatically hold pearls for center line drilling. High precision slide is operated manually with a handle.

Unit Includes(HO-001): Machine with chuck and pearl holders in pairs. 5 MM, 6 MM, 7 MM, 8 MM & 9 MM

Pearl drills must be ordered separately.

Dimensions : 145 x 235 x 122 mm
Wt.: 4.6 kg

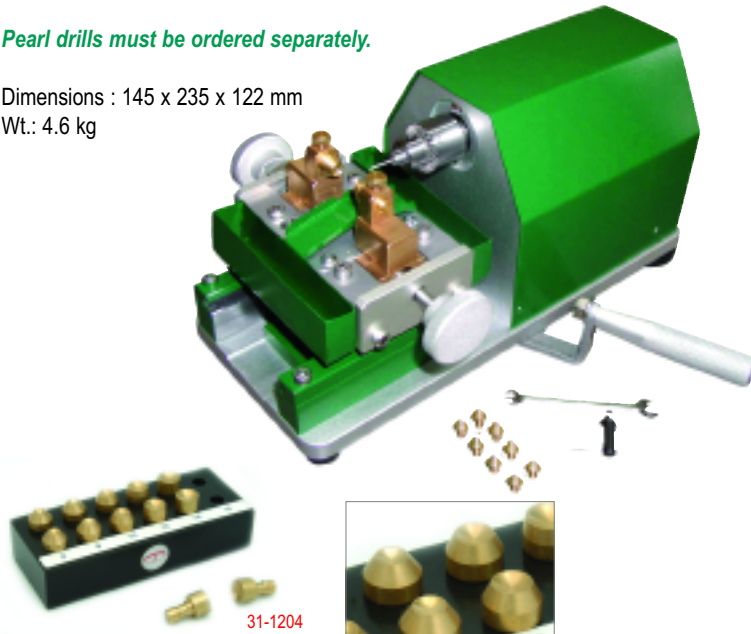

ITEM #	SPECIFICATION
31-1201	PEARL DRILL MACHINE 110V / 60HZ
31-1202	PEARL DRILL MACHINE 220V / 50HZ
31-1203	BELT FOR PEARL DRILL (PAIR)
31-1204	SET OF PEARL HOLDERS (6, 8, 10, 12, 14 & 16MM)

EXTRA HOLDERS TO BE ORDERED SEPARATELY.

Pearl holders from 2-20 mm (increments of 1 mm) on special orders

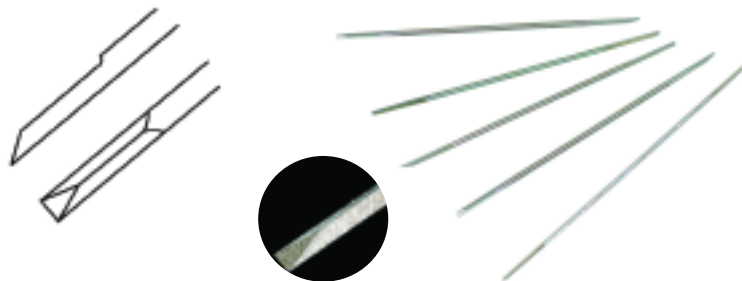

6. Pearl Drill Bits

Special profile tungsten vanadium drills for perfect micro-drilling of pearls. Drill points at both ends. Sizes range from 0.6 to 2.00 mm.

ITEM #	SIZE	ITEM #	SIZE
31-1206	0.60MM	31-1211	1.10MM
31-1207	0.70MM	31-1212	1.20MM
31-1208	0.80MM	31-1213	1.50MM
31-1209	0.90MM	31-1214	1.70MM
31-1210	1.00MM	31-1215	2.00MM

7. High Speed Twist Drill- Set #61- #80

A complete set of 20 drills from size #61 to #80 (0.039" to 0.013"). Made of the finest steel and hardened to Rc 63. Precision ground sizes for drilling accurate holes. Choice of different cases for easy access and protection.



ITEM #	DESCRIPTION
31-1191	SET - 20 PCS WITH DOME CASE
31-1192	SET - 20 PCS WITH METAL CASE
31-1193	SET - 20 PCS WITH PLASTIC CASE

8. Pearl Drill Set

Set of 12 high speed steel drills, all organized on a plastic stand with a protective cover. Shank size 1/8".

ITEM #	SET
31-1221	1.05-3.00MM



9. Pearl Holding Vise- France

Center drill pearls accurately without any mar on the surface. Quick clamp and release system. Thirteen cavities accommodate pearls or beads size 2-10mm.

ITEM #	DESCRIPTION
23-1063	DRILLING VISE



for Pearl Gauges see Page # 167

10. Drill Gauges

Made of heat treated heavy gauge steel to close tolerances. Hole sizes and decimal equivalents are etched on the face.

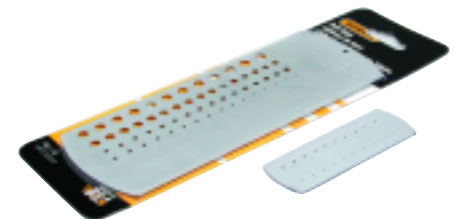

ITEM #	NUMBER SIZE
31-1995	DRILL GAUGE #1-60
31-1996	DRILL GAUGE #61-80

Diamond Coated Drills

These electroplated twist drills are excellent for drilling stones, pearls, glass or ceramics.

for diamond drills See Page # 129





39-2019

Portable LED
worklight see
Page # 50

- Basic unit with 1/2" drill chuck and key
- Speed: 5000 / 6500 / 8500 rpm
- Dimensions: 7" X 9 1/2" X 12 1/2"
- Wt. 9.5 lbs

11. Mini Bench Drill Machine

A mini bench drill just the right size for all drilling projects. Rugged aluminum housing with slotted base to clamp fixtures. Sturdy vertical column with quick release to adjust chuck to table distance. Selectable speeds with calibrated depth control and positive stop.

ITEM #	DESCRIPTION
31-1311	MINI BENCH DRILL 110V / 60HZ
31-1312	MINI BENCH DRILL 220V / 50HZ
31-1313	CHUCK KEY - 1/4"

12. Hand Drill - German

Smooth operating drill with adjustable chuck capacity 1/32"-1/4". Sturdy tool for general purpose use.



ITEM #	DESCRIPTION
23-1141	HAND DRILL - 9 1/2" LONG

13. Drill Press Stand- For Handpiece

Convert your Foredom handpiece (#30) or any 1" diameter handpiece into a precision drill press. Securely holds the handpiece in a vertical position. Lever operated with depth stop for precise drilling, countersinking or reaming. Drill head and table are adjustable for maximum flexibility.



- Basic unit drill press
- Dimensions: 4" X 4 3/4" X 13 1/2"
- Wt. 10 lbs

• *Handpiece not included*

ITEM #	DESCRIPTION
31-1316	DRILL PRESS STAND

14. Poseidon Lathe

A mini lathe manufactured to ISO 9002 standards. Made in rigid all metal construction for high precision accuracy. Features include calibrated hand wheels, adjustable jibs for backlash, ground prismatic bed and a smooth power drive. The machine is versatile for all types of work such as turning, milling, drilling, and carving in metal, wood, plastics and wax.

Specifications:

- Center Height: 48mm(1.8")
- Distance Between Center: 200mm(7.8")
- Turning Diameter Over Bed: 96mm(3.7")
- Cross Slide Travel: 52mm(2.0")
- Speed: 130 / 200 / 350 / 550 / 920 / 1500 / 2450 / 4000 rpm
- Dimensions: 9" X 12" X 23" • Wt. 19 lbs

Basic machine with motor and chuck.

Lathe turning tools are to be ordered separately.

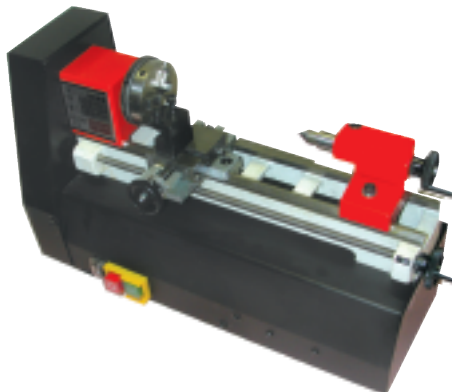

ITEM #	SPECIFICATION
31-1321	110V / 60HZ / 95 W
31-1322	220V / 50HZ / 95 W

POSEIDON LATHE ACCESSORIES

31-1331	TOOL BITS
31-1332	TOP SLIDE
31-1333	FACE PLATE
31-1334	DRILL CHUCK 3 PCS.
31-1335	ROLLING CENTER
31-1336	POWER FEED
31-1337	COLLET HOLDER
31-1338	COLLET SET
31-1339	O-RING BELT
31-1340	POWER FEED V BELT

ACCESSORIES:

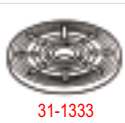



ENGRAVING

■ 850 High Speed Rotary Handpiece	145
■ Attachment Set- 30 Pcs	143
■ Beeswax - Synthetic	139
■ Brass Practice Plates	139
■ Brass Practice Rings	146
■ Burgess Vibro Engraver	145
■ Carbide Bur Set	139
■ Chinese White	145
■ Complete Ultra 850 Rotary System	145
■ Diamond / Stone Bur Set	139
■ Double Ended Tracer	146
■ Electric Engraver	139
■ Elma Engraving Templates	139
■ Elma Engraving Type Sets	138
■ Elma Modulgrav Engraver	138
■ Elma Ringstar Engraver	136
■ Engraving Character Sets	143
■ GRS® Blocks	144
■ GRS® Complete Sharpening Systems	140
■ GRS® Diamond Power Hone	140
■ GRS® GraverMach®	142
■ GRS® GraverMax® SC	145
■ GRS® Gravermeister®	140
■ GRS® Sharpening Fixtures	140
■ GRS® System 3	



■ Handpieces - Gravermeister®	142
■ Handpieces - GraverMach®/ GraverMax®	141
■ Heavy Brass Templates	139
■ Ikohe Inside Ring Engraver	136
■ JUN-AIR® Compressor	143
■ Leather Pads	143
■ Microblock™ Ball Vise	146
■ Microscope System	137
■ Presidium® Inside Ring Engraver	143
■ Presidium® Outside Engraver	146
■ Ring Clamps	143
■ SIL-AIR® Compressor	143
■ Super Pins	146
■ Zodiac Signs	137

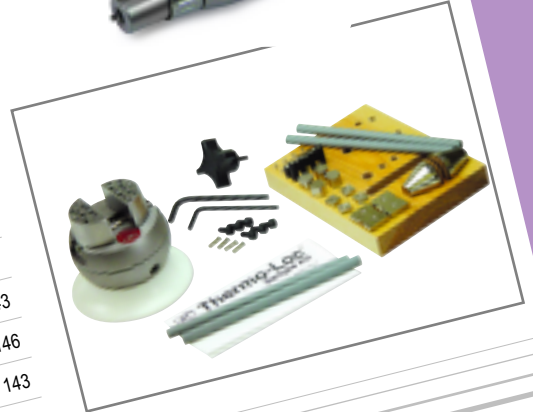

ikohe

Elma

GRS
SILENTAIRE
technology

PRESIDIUM



The Art of Engraving

by **James B. Meek**

A complete authoritative introduction to the art of gun engraving. Contains step-by-step instructions, technical information, designs and layouts to complete each project. Over 1,400 photos, drawings and designs.

61-1115 (Hardcover – 196 pages)



ikoh® 1. Inside Ring Engraver

Point-of-purchase engraving offers customers complete satisfaction. Bright legible marking that makes every ring a memorable possession. Features include automatic centering of rings, one engraving reversible dial, auto-indexing, pressure and depth regulation. Operating instructions included. Dimensions: 12" X 10" X 16³/₈" Wt. 13 lbs.

ITEM #	DESCRIPTION
32-1011	INSIDE RING ENGRAVER
32-1012	REPLACEMENT DIAMOND TIP
32-1013	TEFLON SELF CENTERING JAW- SET OF 3



Machine Includes self centering ring holder, diamond tip, one lettering dial (32-1014), brass practicing rings and instructions.



32-1012



Dial Templates for Ring Engraver

Dial templates with different letter heights and styles are interchangeable on the ring engraver. Dial diameter is 118 mm and engraving ratio is 1/8.



ITEM #	DESCRIPTION
32-1014	BLOCK DIAL REVERSIBLE 7&4MM
32-1015	SCRIPT DIAL ONE SIDE 7MM
32-1016	SPECIAL BLOCK
32-1017	STYLUS FOR SPECIAL BLOCK
32-1018	CONNECTING SCRIPT DIAL
32-1019	CONNECTING BLOCK DIAL

2. Engraving Character Sets- for Outside Engraver

Engraving copy scripts are high accuracy characters made by a "V" groove in bright coated brass. Made of standard 1¹/₄" width blanks, these fonts will fit the machine slides of most manufacturers. Sets of different font styles come neatly organized in a polished wooden box. Individual replacement letters and numbers are available.



ITEM #	DESCRIPTION
32-1051	BOX FOR TEMPLATES



32-1052

A. DOUBLE LINE SCRIPT- 5/8" LETTER

47 Capitals + 56 Lower case + 20 Numerals + 17 Special / Spacers= 140 pcs 32-1052



32-1053

B. FANCY SINGLE LINE SCRIPT- 5/8" LETTER

46 Capitals + 56 Lower Case + 20 Numerals + 18 Special / Spacers=140 pcs 32-1053



32-1054

C. MINIATURE SINGLE LINE SCRIPT - 1/2" LETTER

46 Capitals + 56 Lower Case + 20 Numerals + 18 Special / Spacers=140 pcs 32-1054



32-1055

D. SINGLE LINE SCRIPT - 5/8" LETTER

47 Capitals + 56 Lower Case + 20 Numerals + 13 Special / Spacers=136 pcs 32-1055

E. DOUBLE LINE BLOCK - 5/8" LETTER

104 Capitals + 20 Numerals + 16 Special / Spacers=140 pcs 32-1056

F. SINGLE LINE BLOCK - 5/8" LETTER

46 Capitals + 58 Lower Case + 20 Numerals + 10 Special / Spacers=134 pcs 32-1057

G. MINIATURE SINGLE LINE BLOCK - 1/4" LETTER

104 Capitals + 20 Numerals + 16 Special / Spacers=140 pcs 32-1058



32-1057



32-1058



3. Presidium® Outside Engraver

A manual engraver so easy to operate anyone can get professional results in minutes. Engrave on small articles of jewelry, bracelets, pendants, watch cases and gifts. Uniform character spacing and controlled engraving depth provides clarity of proven quality

- 15 Pantograph ratios from 2½:1 to 6:1
- Universal vise has 360° rotation and 8 index positions
- Height adjustment up to 115mm
- Slide accommodates 1¼" and 2¾" character blanks
- Diamond tip
- Complete instructions included
- Dimensions: 14½" L X 14" W X 11" • Wt. 18 lbs.



Engraving character sets see page # 136

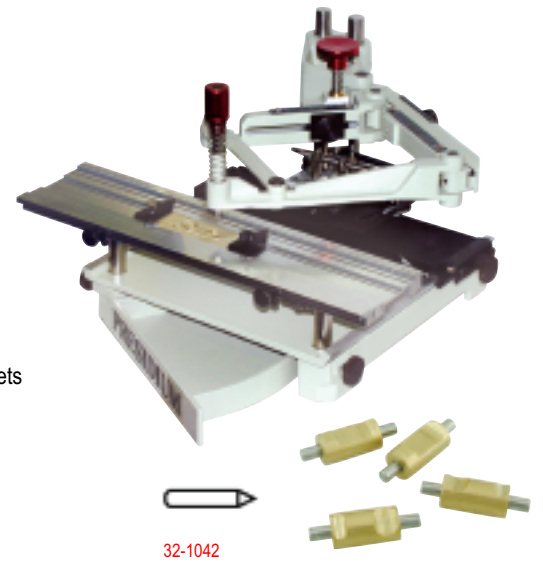

32-1042

32-1043

Machine includes pantograph, diamond tip, copy slide, universal vise, and complete instructions. * Letter set not included

ITEM #	DESCRIPTION
32-1041	ENGRAVING MACHINE
32-1042	REPLACEMENT DIAMOND TIP
32-1043	JEWELRY HOLDER (4 PCS SET)

4. Presidium® Inside Ring Engraver

The Presidium inside ring engraver is manufactured to the highest standards with exterior in powder coated paint. The machine is compact, with diamond tip and automatic letter spacing with uniform depth control. Ideal for all sizes of narrow, wide or stone set rings.

- Ring-holding capacity from Ø 19 to Ø 30 mm
- Self-centering jaws with stone support pad
- Brass practice rings
- Lettering dial upper, lower case and numerals
- Engraves italic 2 mm letter height and block in 1 mm letter height
- Dimensions: 12" X 10" X 16½" • Wt. 15 lbs.



Machine Includes self centering ring holder, diamond tip, one lettering dial (32-1035), brass practicing rings and instructions.

ITEM #	DESCRIPTION
32-1031	INSIDE RING ENGRAVER
32-1012	REPLACEMENT DIAMOND TIP
OPTIONAL DIALS- FOR PRESIDUM RING ENGRAVER	
32-1034	REVERSIBLE DIAL BLOCK 9 MM / 4 MM
32-1035	REVERSIBLE DIAL SCRIPT 9 MM / 4 MM
32-1038	CONNECTING SCRIPT DIAL FOR 32-1031
32-1039	CONNECTING BLOCK DIAL FOR 32-1031
32-1013	TEFLON SELF CENTERING JAW- SET OF 3

5. Zodiac Signs

Made on standard brass blank with bevel edge to fit all standard machines. Available in a set of 12 in a polished wooden box.

- Dimensions: 3" X 3" X 4"
- Wt. 3 lbs.

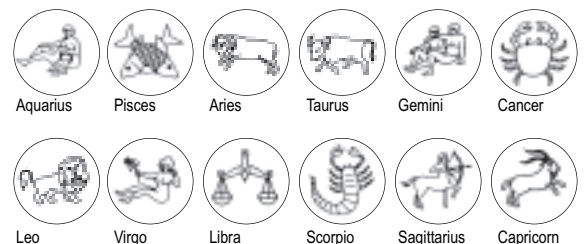

Note: Scripts of different fonts and zodiac signs are to be ordered separately.

ITEM #	DESCRIPTION
32-1048	ZODIAC SIGNS SET OF 12



6. Elma Ringstar Engraver

A top of the line inside ring engraver which features variable engraving letter size from the same letter script. Text is composed on the type holder to give error free engraving. Fine control of depth of engraving by a diamond tip. Easy to set up and operate.

- Features automatic spacing of characters
- Depth control by a micrometer screw
- 360 Rotating ring holder
- Character height is continuously adjustable from 1-3mm

- Dimensions: 8" X 14" X 18"
- Wt. 15 lbs.

Unit Includes: ring holding fixture with delrin jaws, diamond tip, letter type rail, single line script set R5000 and instructions.

ITEM #	DESCRIPTION
32-1071	ELMA RINGSTAR MACHINE
32-1072	TEMPLATE RAIL FOR NEW HERMES
32-1073	CLAMPING WIRE FOR RINGSTAR
32-1074	DIAMOND TIP-FOR ELMA RINGSTAR



7. Elma Modulgrav Engraver

A complete machine dedicated to engraving all articles of jewelry: gold, silver and platinum. The modular design expands the capability of the machine for many types of engraving. Inside and outside engraving, flat and curved engraving. Larger and longer items like trophies and plaques can all be engraved by changing the modules.

- Dimensions: 11" x 15" x 28"
- Wt.: 60 lbs.

Complete Unit Includes: Main frame (without motor), work platform, copy slide, engraving mouse, 32-1082, 32-1084, 32-1087, 32-1111, diamond tip and instructions.

ITEM #	DESCRIPTION
32-1080	MODULGRAV MACHINE COMPLETE
32-1081	MODULGRAV MACHINE BAIC-(WITHOUT MOTOR & MODULES)



Inside ring engraving module
Engrave on the inside of rings
32-1082

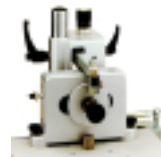

Outside ring engraving module
Engrave on outside of rings
32-1083



Short clamping device
Engrave concave/convex surfaces
32-1084

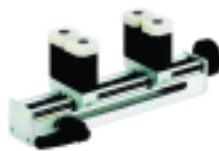

Long clamping device
Clamps objects up to 180mm
32-1085



Universal clamping device
Holds odd shaped items like trophies.
32-1086



Stretching device
Stretch engraving up to 50%
32-1087

Basic Unit Includes: Main frame (without motor), work platform, copy slide, engraving mouse, diamond tip and instructions.
Modules and type sets are to be ordered separately.

Elma Letter Sets fit both Ringstar and Modulgrav Engraving machines



32-1088

ITEM #	DESCRIPTION
32-1082	INSIDE RING ENGRAVER MODULE
32-1083	OUTSIDE RING ENGRAVER MODULE
32-1084	SHORT CLAMPING DEVICE
32-1085	LONG CLAMPING DEVICE
32-1086	UNIVERSAL CLAMP DEVICE (MUST BE USED WITH 32-1085)
32-1087	STRETCHING DEVICE
32-1088	MOTORIZED MODULE FOR MILLING



8. Elma Engraving Templates



ITEM #	DESCRIPTION
32-1092	TEMPLATE 585
32-1093	TEMPLATE 750
32-1094	TEMPLATE 950
32-1095	TEMPLATE 10K
32-1096	TEMPLATE 14K
32-1097	TEMPLATE 18K
32-1098	TEMPLATE 22K

10. Beeswax - Synthetic

Rub a light film on metal surfaces prior to marking layouts and designs.



ITEM #	DESCRIPTION
32-1149	BEEWAX-1 OZ.

12. Brass Practice Rings

Use for layout prior to engraving precious metal rings. Pk/5



ITEM #	DESCRIPTION
32-1146	BRASS RINGS

14. Chinese White

Apply lightly by brush on surfaces prior to layout. Wipes away easily. Available in block form and soluble in water. Wt. 0.35 oz.



ITEM #	DESCRIPTION
32-1148	CHINESE WHITE

KARAT	THOUSANDTH
14K	585
18K	750
20K	832
22K	917

9. Elma Engraving Type Sets

Elma type sets are made in solid brass and nickel plated. Each set contains 128 characters (Includes lower and upper case letters and numerals)



ITEM #	DESCRIPTION
32-1111	ELMA TEMPLATE LETTER -R5000 SCRIPT
32-1112	ELMA TEMPLATE LETTER - 3C CONTINUOUS SCRIPT
32-1113	ELMA TEMPLATE LETTER - 4C BLOCK LETTERS
32-1114	ELMA TEMPLATE LETTER - 6C DOUBLE LINE FANCY SCRIPT

32-1112

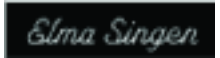

32-1113



32-1114



11. Practice Plates

Use these quality materials to practice your engraving and stone setting. Each material works predictably and consistently to help you improve faster. Flat plates come in steel, half hard brass and copper.



ITEM #	DESCRIPTION
32-1121	2" SQ/STEEL PK/5
32-1122	2" X 4" STEEL PL. PK/5
32-1123	2" SQ/BRASS PL. PK/3
32-1124	2" SQ/COPPER PL. PK/3

13. Double Ended Tracer

An economical steel scribe with precise sharpened points at both ends. Highly accurate for marking layout work when designing.



ITEM #	DESCRIPTION	LENGTH
23-1083	DOUBLE END TRACER	4 1/2"

15. GRS® Heavy Brass Templates

These solid brass templates let you create a fun gift or personal heirloom as you develop your engraving skill. Thick enough for deep relief work; available in plain or satin bead-blast finish. Approximate size 3.5" x 1.7" x 0.1"

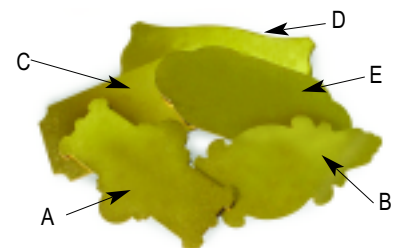

ITEM #	PLAIN FINISH	
32-1131	#011-350	A
32-1132	#011-351	B
32-1133	#011-352	C
32-1134	#011-353	D
32-1135	#011-354	E

ITEM #	BEAD BLAST FINISH	
32-1141	#011-355	A
32-1142	#011-356	B
32-1143	#011-357	C
32-1144	#011-358	D
32-1145	#011-359	E



16. GraverMach®

New air pulse porting technology (patent pending) inside the control unit gives each handpiece excellent range of power with perfect control throughout an expanded range of impact speeds. The GraverMach features 400 to 8000 strokes per minute, a newly developed throttle bias adjustment valve for tailoring throttle response to your work and a dual-stage precision air regulator. Advanced ergonomics include front air pressure adjustment, quick change air couplings, rear mount throttle connection, and an advanced valve pulse unit that operates with virtually no noise or vibration. The GraverMach has connections for two impact handpieces plus an auxiliary air connection for other air tools including the GRS Ultra 850 rotary handpieces.



The GraverMach now has an air output in the rear so it is now "Airtact ready". This is a direct hook-up to Airtact without using T-fittings.

Includes U.S. style IEC electrical cord plus Schuko adapter, foot control and multi-mount air filter. 100-240 Volt, 50-60 Hz. Handpieces sold separately; all GraverMax and GraverMate handpieces can be used with this machine

Specifications:
Width - 5.2" (132mm) Height - .10.8" (274mm)

ITEM #	DESCRIPTION
32-1151	#004-960 GRAVERMACH, 110-240V/ 60-50HZ W/OUT HANDPIECE
32-1152	#004-971 AIRTACT HOOK UP KIT FOR 004-529 (GRAVERMAX)**

Requires compressed air 1.4cfm at 45 psi minimum (40 lpm. at 3 bar minimum).

Compressor not included.

** If a customer orders Airtact to use with an older style GraverMax they will need one of the hookup kits.



Airtact ready

17. GraverMax® SC

The GRS GraverMax tradition continues with this new design. The new, economical GraverMax SC shares many features with the GraverMach including its new air porting technology, quiet operation and a more ergonomic and compact chassis. There are two main differences: the GraverMax SC uses a single stage precision air regulator in place of the dual-stage GraverMach regulator, and there is no throttle bias adjustment valve.

Includes U.S. style IEC electrical cord plus Schuko adapter, foot control and multi-mount air filter. 100-240 Volt, 50-60 Hz. Handpieces sold separately; all GraverMax and GraverMate handpieces can be used with this machine

Specifications:
Width - 5.2" (132mm) Height - .10.8" (274mm)

ITEM #	DESCRIPTION
32-1154	#004-980 GRAVERMAX SC, 110-240V/ 60HZ- W/OUT HANDPIECE
32-1155	#004-972 AIRTACT HOOK UP KIT FOR 004-629 (GRAVERMATE)**

Requires compressed air 1.4 cfm at 45 psi minimum (40 lpm. at 3 bar minimum).

Compressor not included.

** If a customer orders Airtact to use with an older style GraverMate they will need one of the hookup kits.



The GraverMax SC has been upgraded with the same dual-stage precision regulator that is in the GraverMach.



18. GRS® System 3

An affordable impact tool system that gives a wide range of impact power using compressed air. The System 3 is a comfortable, light weight handpiece made in stainless steel. It allows you to engrave, texture, carve and set stones. Use the foot control to start and vary the impact power needed.

System 3 Deluxe Package: Includes handpiece, foot control, air filter-regulator, hand graver handle, 6 QC tool holders, 8 steel points, 2 gravers and instructions.

System 3 Standard Package: Includes handpiece, foot control, air filter-regulator, 3 QC tool holder, 6 steel points and instructions.

Requires compressed air 1.2 cfm at 50 psi minimum.

Compressor not included.

ITEM #	DESCRIPTION
32-1161	#004-781 SYSTEM 3 DELUXE PACKAGE
32-1162	#004-780 SYSTEM 3 STANDARD PACKAGE

ITEM #	DESCRIPTION
32-1165	#004-760 SYSTEM 3 HANDPIECE ONLY
32-1166	#004-771 SYSTEM 3 FOOT CONTROL ONLY
32-1167	#004-762 AIR FILTER-REGULATOR ONLY



QC- Quick Change





19. Handpieces - GraverMach / GraverMax SC

The patented GRS tool system is a breakthrough in speed, convenience and productivity. QC- Quick Change tools are first mounted in interchangeable "QC" holders. Tools can now be interchanged in a few seconds. *Can be used with GraverMax / GraverMate.*

#004-506 Hammer HP

High power tool designed for heavy metal engraving, sculpting and other demanding jobs. Two jaw chuck holds round, square and standard gravers. 5.7" long. Wt 3.8 oz.



ITEM # 32-1171

#004-508 HP

Medium power. General purpose for jewelers and engravers. Two jaw chuck holds 0.06-0.14" round, square or standard gravers, 4.5" long. Wt. 3.8 oz.



ITEM # 32-1173

#004-609 Hammer HP

Great for stone setting, hammering and medium to deep engraving. Use with threaded hammer tip only. Includes one tip. 4.5" long. Wt. 5.5 oz.



ITEM # 32-1175

#004-610 Hammer HP

Stainless steel construction. Excellent for medium to deep engraving. Set screw chuck holds square tools max. 0.10" and round tools max. 0.13" diameter, 4.5" long. Wt. 5.5 oz.



ITEM # 32-1177

#004-710 HP- QC

Perfect for stone setting, hammering, medium to deep engraving. Stainless steel construction with quiet exhaust. Includes 6 QC holders 4.2" long. Wt. 5.9 oz.



ITEM # 32-1179

#004-720 HP- QC

Powerful impact handpiece. A great choice for very heavy metal engraving or hammering. Includes 6 QC holders. 5.0" long. Wt. 5.3 oz.



ITEM # 32-1181

#004-805 QC Hand Handle

Comfortable rubber-covered handle. Ideal for gravers and hand tools. Includes 3 QC holders



ITEM # 32-1183

QC #004-901 HP

Super high power with fine control. Comfortable compact shape with an adjustable side hose connection. Includes 6 QC holders, 2.6" long. Wt. 2.4 oz.



ITEM # 32-1185

QC #004-910 Package

Package includes 901 QC handpiece, QC hand handle, 9 QC tool holders, 6 steel points, 1 GlenSteel graver and QC tool Tray.



ITEM # 32-1187

QC #004-921 Monarch

"Monarch" is the finest impact handpiece for execution of ultra-fine engraving including bulino and banknote styles. Includes 6 QC holders 2.4" long. Wt. 8 oz.



ITEM # 32-1189

#004-940 Magnum HP

Unmatched combination of power and control in a compact handpiece. Includes 6 QC holders, one palm and one oval knob. 2.8" long. Wt. 3.8 oz.



ITEM # 32-1190

Extra QC Holder

Fits on GRS gravers and inserts into QC holder



#004-804 32-1191 pk/3
#004-806 32-1192 pk/10



20. Gravermeister®

Gravermeister- the powerful impact tool. You need only electricity- the compressor is built-in. Precise pulses move a hammer piston back and forth inside the handpiece creating impact power. A foot pedal lets you vary the power as you work. The impact rate is adjustable from 1600 to 2400 impacts per minute. You can engrave deeply in steel and delicately in gold, set stones with confidence, texture metal quickly, sculpt stone and more.

Gravermeister #001-842

Includes compressor unit, foot control, four tools, instructions.
Specifications: 110 V / 60 Hz / 7.0 Amp.
Handpieces not included.



ITEM #	DESCRIPTION
32-1201	#001-842 GRAVERMEISTER 110V/ 60HZ WITHOUT HP

Special Package #001-952

Includes #001-842 Gravermeister, 004-915 QC and 004-712 QC Handpieces, 004-805 QC handle, 004-615 Quick disconnect kit, plus tools and instructions.



ITEM #	DESCRIPTION
32-1204	#001-952 GRAVERMEISTER 110V/ 60HZ- SPECIAL PACKAGE

21. Handpieces - Gravermeister

#004-509 Large HP

Use for heavy metal engraving and other demanding jobs. Two jaw chuck holds round, square and standard gravers. 5.7" long Wt. 7.4 oz.



ITEM # 32-1211

#004-509QC Large HP

A powerful Gravermeister handpiece. Great for heavy metal engraving or hammering. Includes 6 QC holders. 6" long. Wt. 7.9 oz.



ITEM # 32-1213

#004-564 Bulino HP

Small graver handle shaped handpiece with side hose connection. For small stone setting or fine engraving. Set screw holds square and round tools. 2.8" long. Wt. 1.8 oz.



ITEM # 32-1215

#004-611 Hammer HP

Use with threaded hammer tips only. Includes one tip. Set screw chuck holds square and round tools. 4.5" long Wt. 5 oz.



ITEM # 32-1217

#004-612 Hammer HP

Great for stone setting, hammering, and medium to deep engraving. Set screw chuck holds square and round tools. 4.5" long. Wt. 5 oz.



ITEM # 32-1219

#004-712 QC Handpiece

Perfect for stone setting, hammering, and medium to deep engraving. Stainless steel construction with quiet rear exhaust. Includes 6 QC holders. 4.2" long. Wt. 5.9 oz.



ITEM # 32-1221

#004-915 QC Handpiece

Ideal for stone setting and deep relief work. Handpiece with adjustable side nose connection. Includes 6 QC holders. 6" long. Wt. 2.4 oz.



ITEM # 32-1223

#004-615 Quick Disconnect

Switch from one handpiece to another in seconds. Includes main body and two handpiece connectors. Set 3 PCS.



ITEM # 32-1225



22. GRS® Standard Block

The GRS Standard Block rotates on a double ball bearing system. Made of solid stainless steel with steel jaws in a black satin finish.



Specifications:

Block wt.- 19 lbs. (8.6kg) Ball Ø - 5.12" (130mm)
Jaw width - 2.5" (64mm) Jaw height - 1.5" (38mm)
Max. opening - 3" (76mm) Ship weight - 22 lbs.
Overall height: 6"

ITEM #	DESCRIPTION
32-1241	#003-530 STD. BLOCK
32-1242	#003-531 STD. BLOCK & 30 PCS ATTACHMENT

24. GRS® Positioning Vise

Especially for microscope work. Allows you to reposition the work center by simply moving a lever.



Specifications:

Block wt.- 42 lbs. (19.1kg) Ball Ø - 7.1" (180mm)
Jaw width - 3" (76mm) Jaw height - 1.8" (46mm)
Max. opening - 3.5" (89mm) Ship weight - 46 lbs.
Overall height: 7½"

ITEM #	DESCRIPTION
32-1245	#003-541 GRS POSITIONING VISE

26. Microblock™ Ball Vise

The new GRS Microblock™ Ball Vise is the latest product in a broad line of precision work-holding tools. Machined from solid stainless steel and finished with a special low glare treatment to reduce eye strain, this new vise was designed for a unique combination of solid work support in a small and maneuverable size.

ITEM #	DESCRIPTION
23-1351	#003-683 MICRO BLOCK BALL VISE
23-1352	#003-684 M/BLOCK BALL VISE WITH 30 PCS SET
32-1271	#003-667 GRS THERMO-LOC STARTER KIT
32-1272	#003-664 GRS THERMO-LOC 1/2 LB
32-1273	#003-665 GRS THERMO-LOC 1 LB
32-1274	#003-666 GRS THERMO-LOC 5 LB
32-1277	#003-669 GRS THERMO-LOC JAW SET FOR LG.
32-1278	#003-668 GRS THERMO-LOC JAW SET FOR STD.
32-1279	#003-672 GRS BONDING STRIPS SET - 4 PCS

23. GRS® Magna Block

Extra heavy block adds more stability when using power tools. Made of solid stainless steel in a low glare finish to reduce eye strain.



Specifications:

Block wt.- 30 lbs. (13.7kg) Ball Ø - 5.8" (147mm) Jaw width - 3" (76mm) Jaw height - 1.8" (46mm)
Max. opening - 3.5" (89mm) Ship weight - 33 lbs.
Overall height: 7½"

ITEM #	DESCRIPTION
32-1243	#003-021 MAGNA BLOCK
32-1244	#003-522 MAGNA BLOCK & 30 PCS ATTACHMENT

25. GRS® Low Profile Vise

For work that needs a lower vise height. An option for this vise is the use of a heavy duty turntable.



Specifications:

Block wt.- 20.25 lbs. (9.19kg) Ball Ø - 6.125" (147mm)
Jaw width - 3" (76mm) Jaw height - 1.8" (46mm)
Max. opening - 3.5" (89mm) Ship weight - 42.2 lbs.
Overall height: 6¾"

ITEM #	DESCRIPTION
32-1246	#003-615 LOW PROFILE VISE



Weight - 4 lbs. (1.8kg)
Ball diameter - 3.1" (80mm)
Jaw width - 1.8" (46mm)
Jaw height - .87" (22mm)
Max. opening - 2" (50mm)

27. Attachment Set- 30 Pcs



The 30 piece set helps you instantly solve the problems of holding most workpieces. A variety of clamps and pins fit the jaws of all GRS engraving blocks. Includes ring clamps.

ITEM #	DESCRIPTION
32-1261	#003-520 ATTACH. SET

28. Super Pins

Ideal for holding larger items, these heavy-duty plastic over steel pins fit the jaw holes in all GRS Blocks.



Not for use in #003-683

ITEM #	DESCRIPTION
32-1263	#003-547 SET /2 ¾" SH.
32-1264	#003-546 SET /4 ¼" SH.

29. Leather Pads

Thick, top grain leather pads are perfect for safely holding parts in any engraving block or vise. Set of two.



ITEM #	DESCRIPTION
32-1268	#003-609 2" X 3"

30. Ring Clamps

Leather-faced ring clamps let GRS Blocks hold rings securely from the outside so you can set stones, bright cut, and engrave. These clamps also come with the 30-piece attachment set.



ITEM #	DESCRIPTION
32-1269	#003-550 RING CLAMP



31. GRS® Diamond Power Hone

The GRS Diamond Power Hone is fast, precise and produces longer lasting tool edges. Built in a heavy steel housing and powered by a continuous duty motor the diamond wheel runs perfectly true on a double bearing spindle. Change wheels in seconds from coarse to fine.



#001-525 B POWER HONE / 600G DIA. WHEEL 110V

#001-543 B POWER HONE / 600G DIA. WHEEL 220V

Special sharpening fixtures must be ordered separately.

ITEM #	DESCRIPTION
--------	-------------

32-1301	#001-525 B - 110V
---------	-------------------

32-1302	#001-543 B - 220V
---------	-------------------

32. GRS® Diamond and Ceramic Wheels



ITEM #	DESCRIPTION
--------	-------------

32-1321	#002-138 260G DIAMOND WHEEL 5"
---------	--------------------------------

32-1322	#002-055 600G DIAMOND WHEEL 5"
---------	--------------------------------

32-1323	#002-139 1200G DIAMOND WHEEL 5"
---------	---------------------------------

32-1324	#002-415 CERAMIC LAP 6"
---------	-------------------------

32-1325	#002-129 ALUMINUM WHEEL BLANK 5"
---------	----------------------------------

32-1326	#002-537 ALUMINUM WHEEL BLANK 6"
---------	----------------------------------

32-1327	#002-752 DIA. SPRAY ¼ MIC. EXTRA FINE
---------	---------------------------------------

32-1328	#002-753 DIA. SPRAY ½ MIC. FINE
---------	---------------------------------

32-1329	#002-754 DIA. SPRAY 1MIC. MEDIUM
---------	----------------------------------

32-1330	#002-755 DIA. SPRAY 3MIC. COARSE
---------	----------------------------------

32-1331	#001-694 WHEEL STORAGE RACK
---------	-----------------------------

32-1332	#001-838 QUICK WHEEL CHANGE ADAPTERS
---------	--------------------------------------

33. GRS® Complete Sharpening Systems

Professionals can save time with tools that have longer lasting cutting edges. Choose from three sharpening systems.

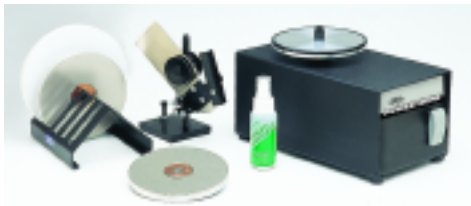

#003-510 Standard System

Includes #003-100 standard Graver Sharpening Fixture, Power Hone, Quick wheel change adapter, 260 and 600 grit diamond wheels, ceramic lap, ½ micron diamond spray, wheel storage rack.

#003-510 COMPLETE STANDARD SYSTEM 110V

#003-557 COMPLETE STANDARD SYSTEM 220V

ITEM #	DESCRIPTION
--------	-------------

32-1311	#003-510 110V /60 HZ
---------	----------------------

32-1312	#003-557 220V / 50 HZ
---------	-----------------------



#003-577 Dual Angle System

Includes #003-570 Dual Angle Sharpening Fixture, Power Hone, Quick wheel change adapter, 260 and 600 grit diamond wheels, ceramic lap, ½ micron diamond spray, wheel storage rack.

#003-577 COMPLETE DUAL ANGLE SYSTEM 110V

#003-572 COMPLETE DUAL ANGLE SYSTEM 220V

ITEM #	DESCRIPTION
--------	-------------

32-1314	#003-577 110V /60 HZ
---------	----------------------

32-1315	#003-572 220V / 50 HZ
---------	-----------------------

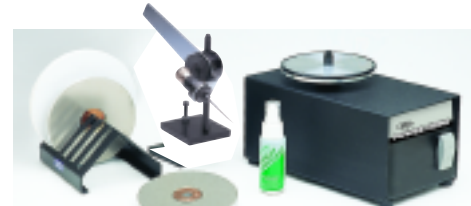

#003-610 Quick Change System

Includes #003-580 Quick change sharpening fixture, Power Hone, Quick wheel change adapter, 260 and 600 grit diamond wheels, ceramic lap, ½ micron diamond spray, wheel storage rack.

#003-610 COMPLETE Q/CHANGE SYSTEM 110V

#003-611 COMPLETE Q/CHANGE SYSTEM 220V

ITEM #	DESCRIPTION
--------	-------------

32-1317	#003-610 110V /60 HZ
---------	----------------------

32-1318	#003-611 220V / 50 HZ
---------	-----------------------



34. GRS® Sharpening Fixtures

Standard Graver Sharpener

Hold tools with or without handles. Precise degree dial sets an accurate cutting angle.



#003-100 Standard Graver Sharpening Fixture
#003-502 Extra Post Assembly

ITEM #	DESCRIPTION
32-1341	#003-100
32-1342	#003-502

Dual Angle Sharpener

Holds a wider variety of tools. With two degree dials, you can set the elevation angle and the rotation angle.



#003-570 Dual Angle Sharpening Fixture
#003-571 Dual Angle Sharpening Fixture Head

ITEM #	DESCRIPTION
32-1344	#003-570
32-1345	#003-571

Quick Change Sharpener

With the QC Sharpening fixture, just insert your tool with its QC holder and sharpen. The two degree dials make sharpening faster.

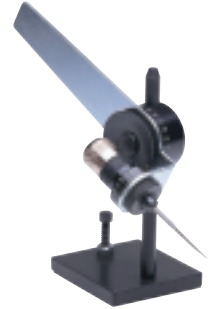

#003-580 Quick Change Sharpening Fixture
#003-581 Quick Change Sharpening Fixture Head

ITEM #	DESCRIPTION
32-1347	#003-580
32-1348	#003-581

35. 850 High Speed Rotary Handpiece

An ultra high speed rotary handpiece 320,000 rpm for effortless engraving, decorating and grinding of wood, metal, shell, plastic, glass, stones, almost any material. It is remarkably free from vibration and noise. No lubrication is required. Designed with a comfortable contoured shape to reduce fatigue. The ultra 850 accepts only 1/8" shank burs.



Includes handpiece, tubing, connectors, carbide bur and instructions. Requires 1.3cfm at 30-35 psi. (38lpm. at 2-2.5 bar) Connects directly to GraverMaxSC, GraverMach or any regulated air supply.

ITEM #	DESCRIPTION
32-1351	#004-850 GRS ULTRA HIGH SPEED 850 HANDPIECE

36. Complete Ultra 850 Rotary System

Includes system stand, filter/regulator, pressure gauge, foot control, GRS Ultra 850 handpiece, handpiece storage station, bur storage station and hook-up hardware. System stand sits on any bench top or can be fastened to a wall or table leg.



ITEM #	DESCRIPTION
32-1354	#004-861 COMPLETE ULTRA 850 SYSTEM

#004-863 GRS Foot Control for Rotary Air HP

Fits to GraverMax, GraverMate or any source of compressed air. Steel construction. Includes tubing and connectors.



ITEM #	DESCRIPTION
32-1355	#004-863 AIR FOOT CONTROL

Burs for the HS HP 850



37. Carbide Bur Set

6-piece versatile carbide assortment for most metals, wood and general work. 0.062" (1.6mm) shanks.

ITEM #	DESCRIPTION
32-1358	#004-511



38. Diamond / Stone Bur Set

4 diamond and 2 stone burs especially for glass, stone and similar materials. 0.062" (1.6mm) shanks.

ITEM #	DESCRIPTION
32-1359	#004-512



GRS

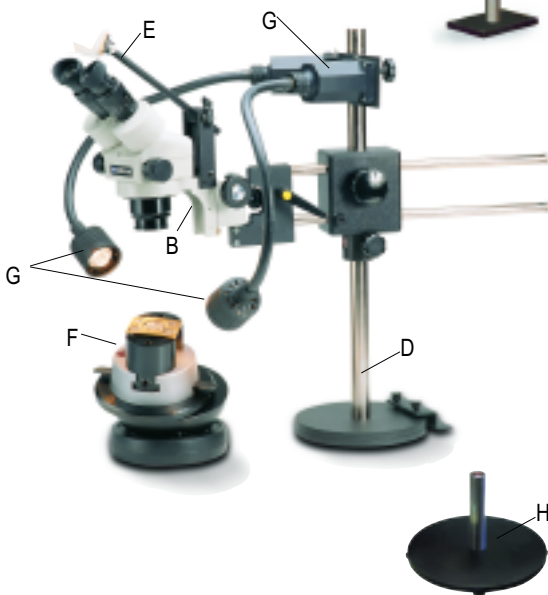

39. Microscope Meiji System

The GRS microscope has the right high quality optics for fine engraving. Magnified viewing lets you see clearly what your hands and tools are doing. Using this microscope, jewelers set every stone perfectly the first time..... even intricate settings with small stones.

#003-563NFB: Use with GRS Acrobat stand. Includes stereo zoom microscope body, 10X wide field eye pieces, 0.5 objective lens. Magnification range 3.5 to 22.5. Working distance 6" (150mm)

#003-563: Same as above but adds focus block needed for stand

#003-630: GRS Acrobat stand. Easy to position. Arms may be locked if needed. Includes headrest.

#003-584: Head rest kit for **#003-563** microscope.

#003-541: GRS Positioning vise.

#003-616-V2: Turntable to reposition the work under the center of the microscope.

ITEM #	DESCRIPTION	
32-1371	#003-563NFB GRS® MEIJI MICROSCOPE	A
32-1372	#003-563 GRS® MEIJI MICROSCOPE FOCUS BLOCK	B
32-1373	#003-630 GRS® ACROBAT MICROSCOPE STAND	C
32-1374	#003-564 GRS® ORIGINAL MICROSCOPE STAND	D
32-1375	#003-584 GRS® HEAD REST KIT	E
32-1245	#003-541 GRS® POSITIONING VISE	F
32-1377*	#022-268T MICROSCOPE RING LIGHT COMPLETE-110V	
32-1378*	#022-268T-220 MICROSCOPE RING LIGHT COMPLETE-220V	
32-1379*	#022-338 SCOPE LIGHT BULB (TCHNP) RING TYPE	
32-1380	#003-597 TWIN HALOGEN LIGHTS-110V	G
32-1381	#003-596 TWIN HALOGEN LIGHTS-220V	G
32-1382*	#003-648 MICROSCOPE EYE PIECE 10X	
32-1383*	#003-680 HEAVY DUTY UTILITY SHELF	
32-1384	#003-616-V2 TURNTABLE BASE	H

* pictures not shown

40. Electric Engraver

A very useful tool for engraving symbols, layout work and identification marks. High speed reciprocation of a finely pointed carbide tip marks the object.



ITEM #	DESCRIPTION
32-1401	ELECTRIC ENGRAVER 110V/60HZ
32-1402	ELECTRIC ENGRAVER 220V/50HZ
32-1403	CARBIDE POINT
32-1404	DIAMOND POINT

41. Burgess Vibro Engraver

Rugged industrial engraver that hammer marks permanently into hardened steel, metal, stone, ceramic, glass or wood. Tungsten carbide tip vibrates at 7,200 strokes per minute.

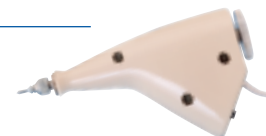

ITEM #	DESCRIPTION
32-1411	BURGESS VIBRO 110V/60HZ
32-1412	BURGESS VIBRO 220V/50HZ
32-1413	CARBIDE POINT
32-1414	DIAMOND POINT

SILENTAIRE
Technology

42. Sil-AIR® Compressor

Sturdy rugged construction, low noise level and virtually vibration free. Includes filter/regulator with automatic drain, condensate collection bottle and line pressure gauge. Dimensions: 18" L X 18" W X 26" Ht. Wt.: 68lbs



Specifications:

Displacement	2.12 cfm
Max. Pressure	114 psi (8 bar)
Power	6.5 amps
Tank	6 gal.
Noise Level	40 dB
32-1471	½HP /110V/60HZ



43. JUN-AIR® Compressor

A top quality air compressor that is efficient and exceptionally quiet. Comes complete with filter/regulator and line pressure gauge. Includes a ½ liter of oil. Dimensions: 15" L X 15" W X 22" Ht. Wt.: 57lbs

Specifications:

Displacement	2.15 cfm
Max. Pressure	120 psi (8 bar)
Power	6.5 amps
Tank	4 gal.
Noise Level	45 dB
32-1461	½HP /110V/60HZ



FILES

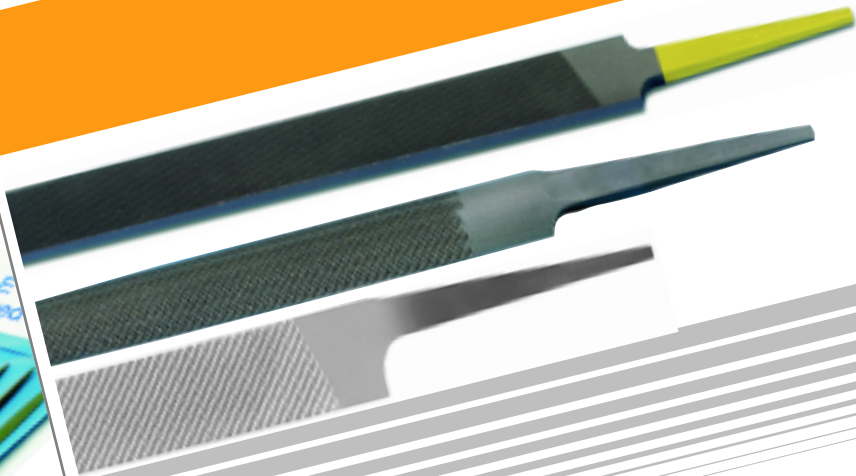
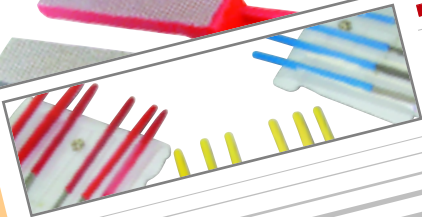
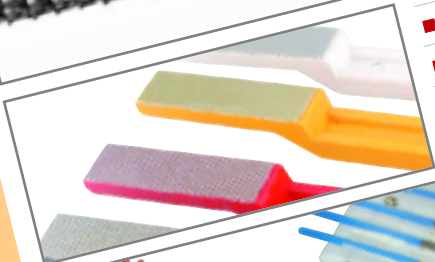
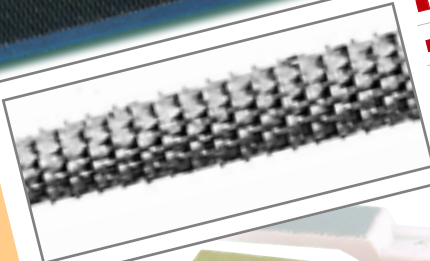
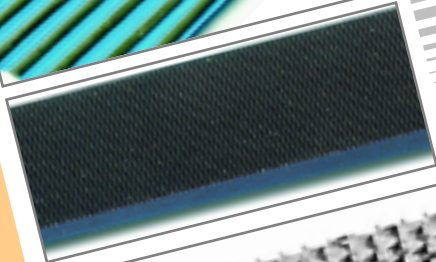
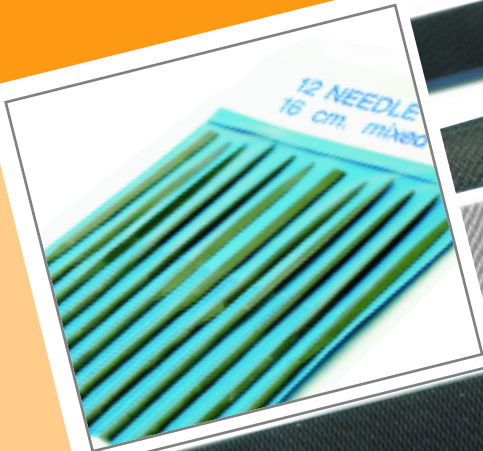

■ 3M® Diamond Files	156	■ Swiss Precision Files	148
■ Baiter Escapment Files	155	■ Valtitan Files- Swiss	150
■ Baiter Files	154, 155	■ Valtitan Needle Files- Swiss	156
■ Baiter Needle Files & Handles	153	■ Wax File Set	154
■ Baiter Swiss Precision Files	152	■ Wax Files- Baiter	156
■ Diamond Needle Files	151	■ Wax Hand Files- Flat	156
■ Double-End Vulcanite Files	156	■ Wood File Handles	156
■ Escapement Files	151, 155		
■ File Cleaner	156		
■ Grobet Files-Swiss	148, 149, 150		
■ Needle File Handles	156		
■ Needle File Sets-German	151		
■ Needle File Sets-Swiss	151		
■ Needle Files- Swiss	149		



Practical Jewelry Making by Loosli/Merz/Schaffner

















A comprehensive book providing practical, instructional knowledge for proficiency in the jewelry trade. Extensive coverage of basic operations including filing, sawing, soldering and drilling. Complex forming, assembling, setting and finishing operations are also covered.

61-1019 (Hardcover – 164 pages)



1. Swiss Precision Files

High precision durable files, manufactured from chrome alloy steel and heat treated by a special process to guarantee sharper teeth for outstanding cutting performance on all hard and soft metals, including platinum. File measurement is from the point to where the teeth end.













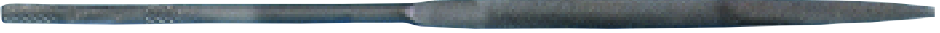

				ITEM #	CUT
	BARRETTE	$\frac{23}{32}$ "/18.3mm x $\frac{3}{16}$ "/4.0mm Length 6" / 150mm	Cut on wide flat face, tapered in width and thickness.	33-1011	#00
				33-1012	#0
				33-1013	#1
				33-1014	#2
				33-1015	#4
					HALF-ROUND
				33-1017	#0
				33-1018	#1
				33-1019	#2
				33-1020	#4
					HALF-ROUND RING
				33-1022	#0
				33-1023	#1
				33-1024	#2
				33-1025	#4
					THREE SQUARE
				33-1028	#2
				33-1029	#4
	HAND	$\frac{3}{4}$ "/19.1mm x $\frac{5}{32}$ "/4.0mm Length 6" / 150mm	Parallel in width and tapered in thickness. Cut on top, bottom and on one side.	33-1031	#00
				33-1032	#0
				33-1033	#1
				33-1034	#2
				33-1035	#4
					ROUND
				33-1038	#2
				33-1039	#4
	SQUARE	$\frac{15}{64}$ "/6.0mm Length 6" / 150mm	Double cut, square in cross section with a gradual taper.	33-1042	#0
				33-1043	#2
				33-1044	#4
	KNIFE	$\frac{23}{32}$ "/18.3mm x $\frac{5}{32}$ "/4.0mm Length 6" / 150mm	Wedge shape cross section tapered in width and thickness.	33-1047	#0
				33-1048	#2
				33-1049	#4



2. Needle Files- with Round Knurled Handles-Swiss

Precision needle files for fine working. Made of the finest chrome steel, hardened and tempered to ensure efficient cutting.

• Length 6¼" (16cm) cut portion of 3" (75 mm) • Length 7¾" (20cm) cut portion of 4⅛" (105 mm)

		CUT	16CM	20 CM
 BARRETTE		#00	33-1051	—
		#0	33-1052	33-1102
		#2	33-1053	33-1103
		#4	33-1054	33-1104
		#6	33-1055	33-1105
		 HALF-ROUND		#00
#0	33-1057			33-1107
#2	33-1058			33-1108
#4	33-1059			33-1109
#6	33-1060			—
 CROSSING				#0
		#2	33-1063	33-1113
		#4	33-1064	33-1114
		#6	33-1065	—
 THREE SQUARE		#00	33-1066	—
		#0	33-1067	33-1117
		#2	33-1068	33-1118
		#4	33-1069	33-1119
		#6	33-1070	33-1120
 EQUALLING		#00	33-1071	—
		#0	33-1072	33-1122
		#2	33-1073	33-1123
		#4	33-1074	33-1124
		#6	33-1075	—
 ROUND		#00	33-1076	—
		#0	33-1077	33-1127
		#2	33-1078	33-1128
		#4	33-1079	33-1129
		#6	33-1080	—
 SQUARE		#00	33-1081	—
		#0	33-1082	33-1132
		#2	33-1083	33-1133
		#4	33-1084	33-1134
		#6	33-1085	—
 KNIFE		#0	33-1087	33-1137
		#2	33-1088	33-1138
		#4	33-1089	33-1139
		#6	33-1090	—



3. Valtitan Files- Swiss

The hardest files known as Rc72, made from graded alloy steel and corrosion resistant. An excellent file for use on platinum and other hard metals. All shapes and cuts are available.

HAND	6" / 150MM
-------------	-------------------



HALF- ROUND RING	6" / 150MM
-------------------------	-------------------



HALF- ROUND	6" / 150MM
--------------------	-------------------



BARRETTE	6" / 150MM
-----------------	-------------------



THREE SQUARE	6" / 150MM
---------------------	-------------------



ITEM #	CUT
--------	-----

	33-1171 #00
	33-1172 #0
	33-1173 #2
	33-1175 #0
	33-1176 #2
	33-1178 #0
	33-1179 #2
	33-1181 #0
	33-1182 #2
	33-1183 #0
	33-1184 #2



4. Valtitan Needle Files- Swiss

Overall length 7"/180mm. Cutting length 3 3/4".



	#00	#0	#2
EQUALLING	33-1201	33-1202	33-1203
HALF- ROUND	33-1204	33-1205	33-1206
BARRETTE	33-1207	33-1208	33-1209
ROUND	33-1211	33-1212	33-1213
SQUARE	33-1214	33-1215	32-1216
THREE SQ.	33-1217	33-1218	33-1219
SET OF 6	33-1221	33-1222	33-1223

	Coarse			Medium			Fine		
Teeth per Inch	41	51	64	79	97	117	142	173	
Swiss Files 4-8"	00	0	1	2	3	4	-	6	
Escapement Files	-	-	0	-	2	3	4	-	
Needle Files	-	-	0	-	2	3	4	-	

Swiss Precision Files are the most accurate long lasting files of proven performance. Select a file of the cut needed for specific applications.

Coarse cut files: FOR ROUGHING AND SHAPING

Medium cut files: FOR SMOOTHING

Fine cut files: FOR FINAL FINISHING



5. Escapement Files

Made of chrome alloy steel. These square handle files of different shapes from coarse to fine grades, are suitable for every type of miniature sculpting. Also available in sets. Overall length 5½"-14cm, length of cut is ⅛" to ⅜" (39.7 to 65.1mm) depending upon shape.

	#0	#2	#4
PILLAR	—	33-1142	33-1143
HALF ROUND	33-1144	33-1145	33-1146
BARRETTE	33-1147	33-1148	33-1149
ROUND	33-1151	33-1152	33-1153
SQUARE	33-1154	33-1155	33-1156
THREE SQ.	33-1157	33-1158	33-1159
CROSSING	—	33-1162	33-1163
KNIFE	—	33-1165	33-1166
SET OF 12	—	33-1168	33-1169

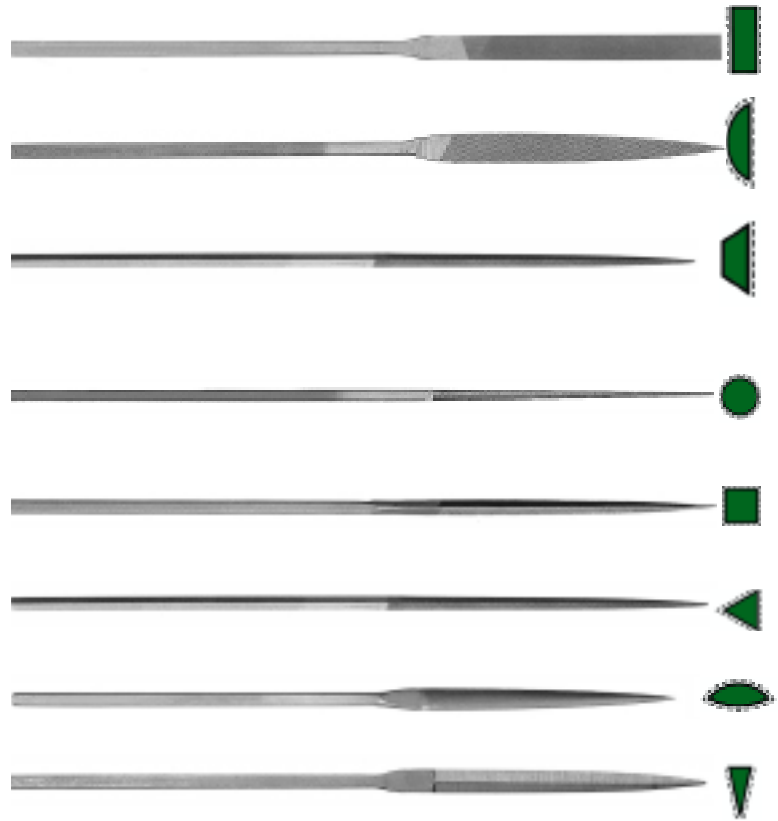

6. Needle File Sets- Swiss

Precision needle files made of the finest chrome steel and heat treated to give twice the cutting power. Indispensable for use in detailing delicate designs.

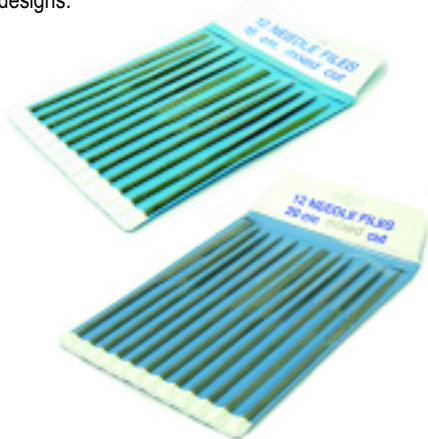

ITEM #	DESCRIPTION
33-1241	SET OF 12 -160 MM
33-1242	SET OF 12 -200 MM

7. Needle File Sets- German

Precisely graded needle files in the most popular shapes of half-round, barrette, three square, equalling round and square files. Overall length 160mm.

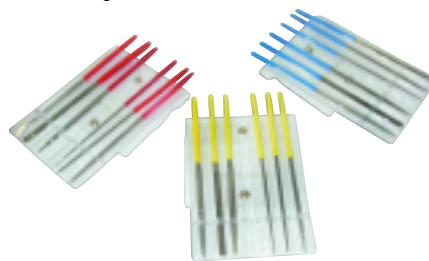

ITEM #	DESCRIPTION
33-1251	SET OF 6-#2 YELLOW
33-1252	SET OF 6-#3 RED
33-1253	SET OF 6-#4 BLUE
33-1255	SET OF 12- #2 YELLOW
33-1256	SET OF 12- #3 RED
33-1257	SET OF 12- #4 BLUE

8. Diamond Needle Files

Made of virgin diamond particles electroplated on high precision steel blanks. Comfortable handles provide maximum strength, flexibility and durability. Overall length 5½".

















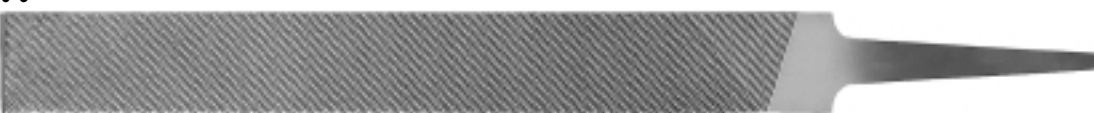

ITEM #	DESCRIPTION
33-1261	THREE SQUARE
33-1262	PILLAR
33-1263	HALF-ROUND
33-1264	ROUND
33-1265	SQUARE
35-1266	SET OF 5 PCS



9. Premium Swiss Precision Files

High precision durable files, manufactured from chrome alloy steel and heat treated by a special process to guarantee sharper teeth for outstanding cutting performance on all hard and soft metals, including platinum. File measurement is from the point to where the teeth end.

				ITEM #	CUT
 BARRETTE 15.3mm x 3.5mm Length 6" / 150mm No. 119-6"		Cut on wide flat face, tapered in width and thickness.		33-1301	#00
				33-1302	#0
				33-1303	#1
				33-1304	#2
				33-1305	#4
 HALF-ROUND 15.3mm x 4.7mm Length 6" / 150mm No. 106-6"		Flat on one side and radius on the other. Cut on both sides.		33-1306	#00
				33-1307	#0
				33-1308	#1
				33-1309	#2
				33-1310	#4
 HALF-ROUND SILM 12.7mm x 3.5mm Length 6" / 150mm No. 107-6"		Flat on one side and shallow radius on the other. Cut on both sides.		33-1311	#00
				33-1312	#0
				33-1313	#1
				33-1314	#2
				33-1315	#4
 THREE SQUARE 10.3mm Length 6" / 150mm No. 108-6"		Equiangular tapered file with sharp corners and cut on all sides.		33-1317	#0
				33-1319	#2
				33-1320	#4
 HAND 18.5mm x 4.0mm Length 6" / 150mm No. 100-6"		Parallel in width and tapered in thickness. Cut on top, bottom and on one side.		33-1321	#00
				33-1322	#0
				33-1323	#1
				33-1324	#2
				33-1325	#4
 ROUND 5.9mm Length 6" / 150mm No. 114-6"		Double cut, round in cross section with a gradual taper.		33-1329	#2
				33-1330	#4
 SQUARE 5.5mm Length 6" / 150mm No. 111-6"		Double cut, square in cross section with a gradual taper.		33-1334	#2
				33-1335	#4
 KNIFE 17.9mm x 3.5mm Length 6" / 150mm No. 117-6"		Wedge shape cross section tapered in width and thickness.		33-1339	#2
				33-1340	#4
 CROSSING 14.8mm x 5.0mm Length 6" / 150mm No. 118-6"		Shallow radius on both sides. Double cut, tapered in width and thickness.		33-1342	#0
				33-1344	#2
				33-1345	#4



10. Needle Files- with Round Knurled Handles-Swiss

A selection of files with various cross sections and cuts. All with round knurled handles for a positive grip.
Sold each

				CUT	160MM	200MM
	BARRETTE	160mm:5.1mm x 1.8mm 200mm:5.8mm x 2.2mm	No. 132	#00	33-1351	33-1401
				#0	33-1352	33-1402
				#2	33-1353	33-1403
				#4	33-1354	33-1404
	HALF-ROUND	160mm:5.6mm x 1.7mm 200mm:6.3mm x 2.0mm	No. 123	#00	33-1355	33-1405
				#0	33-1356	33-1406
				#2	33-1357	33-1407
				#4	33-1358	33-1408
	CROSSING	160mm:5.1mm x 2.0mm 200mm:6.0mm x 2.4mm	No. 128	#00	33-1361	33-1411
				#0	33-1362	33-1412
				#2	33-1363	33-1413
				#4	33-1364	33-1414
	THREE SQUARE	160mm:3.8mm 200mm:4.4mm	No. 124	#00	33-1365	33-1415
				#0	33-1366	33-1416
				#2	33-1367	33-1417
				#4	33-1368	33-1418
	EQUALLING	160mm:5.4mm x 1.2mm 200mm:6.5mm x 1.3mm	No. 121	#00	33-1371	33-1421
				#0	33-1372	33-1422
				#2	33-1373	33-1423
				#4	33-1374	33-1424
	ROUND TAPERED	160mm:2.9mm 200mm:3.5mm	No. 126	#00	33-1375	33-1425
				#0	33-1376	33-1426
				#2	33-1377	33-1427
				#4	33-1378	33-1428
	SQUARE TAPERED	160mm:2.4mm 200mm:2.8mm	No. 125	#00	33-1381	33-1431
				#0	33-1382	33-1432
				#2	33-1383	33-1433
				#4	33-1384	33-1434
	KNIFE	160mm:5.4mm x 1.5mm 200mm:6.4mm x 1.8mm	No. 127	#00	33-1385	33-1435
				#0	33-1386	33-1436
				#2	33-1387	33-1437
				#4	33-1388	33-1438

Needle File Sets- Assorted

CUT	ITEM #	160MM	#
#2	33-1491	SET OF 12	158
#4	33-1492	SET OF 12	148



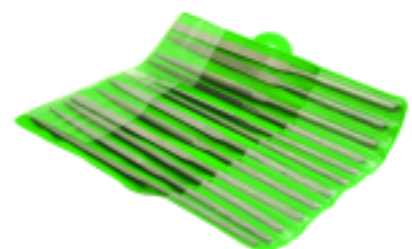
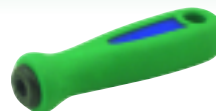









Baiter locking handles for needle files on page #154



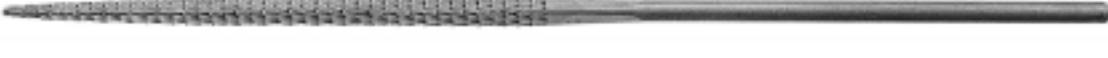

11. Wax Files- Swiss

Coarse tooth style, ideally suited for shaping waxes and soft materials such as wood and plastic. The tooth profile does not allow the material to clog as in conventional files.

				ITEM #	CUT
				33-1441	# 4
	EQUALLING	5.0mm x 2.0mm Length 140mm / 5.5"	No. 621		
				33-1442	#4
	FLAT	5.5mm x 2.0mm Length 140mm / 5.5"	No. 622		
				34-1443	#4
	HALF-ROUND	6.2mm x 2.5mm Length 140mm / 5.5"	No. 623		
				33-1444	#4
	ROUND	3.7mm Length 140mm / 5.5"	No. 626		
				33-1445	#4
	SQUARE	3.3mm Length 140mm / 5.5"	No. 625		
				33-1446	#4
	THREE SQUARE	3.8mm Length 140mm / 5.5"	No. 627		



Wax File Set- Swiss

A complete set with one each of equalling, flat, half-round, round, square and three square. All have knurled handles. Comes in plastic pouch.



No. 628

Assorted shapes	SET OF 6	Cut #4 Length 140mm / 5.5"
------------------------	-----------------	-------------------------------

33-1447 #4

File Handles- Swiss

Ergonomic file handle provides protection and working comfort over long periods. Tang fits in hole and provides positive alignment.

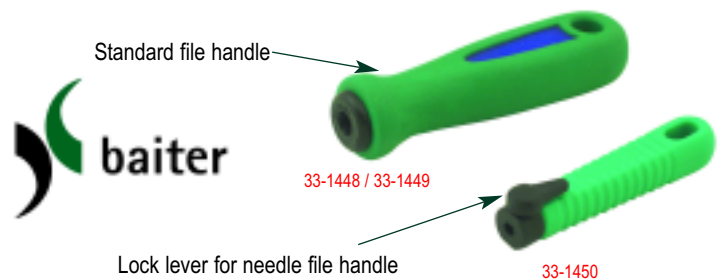

ITEM #	DESCRIPTION	Ø X L	HOLDS
33-1448	FILE HANDLE	3 X 90MM	4"-6" FILES
33-1449	FILE HANDLE	4 X 90MM	6"-8" FILES
33-1450	N/FILE HANDLE	4 X 70MM	4"-6" FILES



12. Escapment Files

Widely used by jewelers and watch makers. Recognized for exceptional durability due to its special manufacturing process. A selection of shapes in different cuts to suit all applications.

ITEM #	CUT
33-1452	#2
33-1453	#4



	BARRETTE	File Length: 40mm Overall Length: 6"/ 150mm	No. 3010
---	-----------------	--	-----------------



	CROSSING	File Length: 40mm Overall Length: 6"/ 150mm	No. 3009
---	-----------------	--	-----------------

33-1455	#2
33-1456	#4



	PILLAR	File Length: 55mm Overall Length: 6"/ 150mm	No. 3017
---	---------------	--	-----------------

33-1458	#2
33-1459	#4



	ROUND	File Length: 55mm Overall Length: 6"/ 150mm	No. 3021
--	--------------	--	-----------------

33-1460	#0
33-1461	#2
33-1462	#4



	SQUARE	File Length: 55mm Overall Length: 6"/ 150mm	No. 3020
---	---------------	--	-----------------

33-1463	#0
33-1464	#2
33-1465	#4



	THREE SQUARE	File Length: 40mm Overall Length: 6"/ 150mm	No. 3014
---	---------------------	--	-----------------

33-1466	#0
33-1467	#2
33-1468	#4



	KNIFE	File Length: 55mm Overall Length: 6"/ 150mm	No. 3004
---	--------------	--	-----------------

33-1470	#2
33-1471	#4

A complete set of assorted shapes of files. Genuine Swiss quality made from finest steel. All have knurled handles. Comes in plastic pouch.

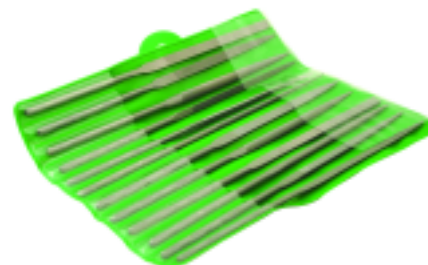

33-1475	#2
33-1476	#4

Assorted shapes	SET OF 12	Overall Length: 6"/ 150mm	No. 3092
------------------------	------------------	---------------------------	-----------------



13. Double-End Vulcanite Files

Double-End Vulcanite Files have tooth forms especially designed for use on wax, plastic and other soft materials. One file has both coarse and fine cuts.

ITEM #	DESCRIPTION
33-1391	DOUBLE END FILES 8" - VALLORBE
33-1392	DOUBLE END FILES 8" - BAITER
33-1393	DOUBLE END FILES 8" - VALUE

14. Wax Hand Files- Flat

Truly the best file for every wax modeler. Special tooth form resists wax loading.

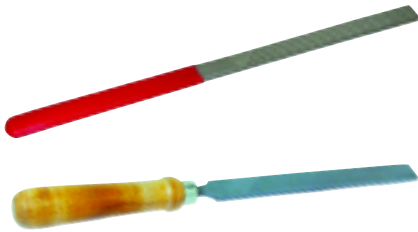

15. Wax File Set- Value

Set of 6 most popular shapes. Teeth will not clog with wax or plastic. Shapes include equaling, flat, half-round, round, square and three square. Overall length 6".



16. 3M® Diamond Files

Diamond files can smooth finish all precious metal, glass, ceramic and stone. Four different grit sizes. Size 1/2" X 1 3/4".



ITEM #	DESCRIPTION
33-1397	PLASTIC HANDLE-8 1/2"
33-1398	WOOD HANDLE-10"

ITEM #	DESCRIPTION
33-1399	SET OF 6 PCS.

ITEM #	COLOR	MIC/ GRIT
33-1481	BLACK	125/120
33-1482	RED	74/200
33-1483	YELLOW	40/400
33-1484	WHITE	20/800

17. Needle File Handles

Push Type Handle: Holds files securely by a spring clamp and knob. Made in Germany

Chuck Type Handle: Securely holds file tang when chuck is tightened.

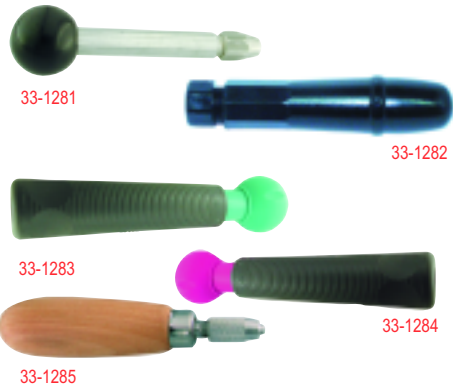

18. Wood File Handles

Smooth finish wood handles with steel ferrules to prevent splitting.



ITEM #	DESCRIPTION
33-1281	ALUMINUM HANDLE-5"
33-1282	PVC/HANDLE 3 1/2"
33-1283	PUSH TYPE 3-4MM
33-1284	PUSH TYPE 2-3MM
33-1285	CHUCK TYPE-WOODEN 5 1/2"

ITEM #	DESCRIPTION
33-1291	WOODEN - 3"
33-1292	WOODEN - 4"
33-1293	WOODEN - 5"

Extend File Life

Clean files regularly to keep them cutting sharp and fast

19. File Cleaner

Steel bristle, mounted in a shaped wooden handle, used for cleaning debris from clogged file teeth. Overall length 8 1/4".



ITEM #	DESCRIPTION
33-1296	FILE CLEANER



FLEXSHAFTS



■ Badeco® Hammer Handpieces	161	■ Handpiece - #30	160
■ Badeco® Rotary Handpieces - #437	160	■ Handpiece - #35	160
■ Chuck Adapters	159	■ Handpieces QC #18 & #18D	160
■ Chuck Key	160	■ Handpieces QC- #40 Italy	160
■ Electer E-max - NSK	162	■ Marathon Micromotor	159
■ Electronic Foot Control -FCT	158	■ Micro-Motors	162
■ Electronic Foot Control -SCT	158	■ Motor Hangers	159
■ Espert 500C- NSK	161	■ Pneumatic Air Scribe®	159
■ Faro® Handpieces	158	■ RB-Max Flexshaft	159
■ Flexshaft System- 2220 Kit	158	■ Replacement Parts	159
■ Flexshaft System- 2230 Kit	159	■ Technique Handpiece	161
■ Flexible Shaft Motors	160		
■ Hammer HP #15 & #15D	160		
■ Handpiece - #25C	160		

ikohe

NSK

FOREDOM®



The Design and Creation of Jewelry

by **Robert Von Neumann**

A complete reference guide showing traditional and contemporary methods and materials of jewelry making. Learn basic and specialized metalworking, shaping and decorative techniques. Covers cutting, stamping, pickling, coloring, polishing and design transfer methods.

61-1011 (Softcover - 321 pages)



1. SR Motor Flexshaft System - 2220 Kit

- SR ball bearing motor 1/8hp, 18,000 rpm with forward and reverse switch
- Includes FCT-1 electronic foot control, #20 quick-change handpiece
- Ideal for precision prong setting and seat cutting • Wt. 12½ Lbs

Unit Includes:

54 piece accessory kit rotating bur stand, mounted points, wire and bristle brush, sanding drums, assorted buffs, polishing wheels, compounds and flexshaft grease

ITEM #	DESCRIPTION
34-1011	2220 KIT -110V / 60HZ
34-1012	2220 KIT -220V / 50HZ

2. SR Motor Flexshaft System - 2230 Kit

- SR ball bearing motor 1/8hp, 18,000 rpm with forward and reverse switch
- Includes FCT-1 electronic foot control , #30 handpiece
- With Jacobs chuck 0"-5/8" (0-4mm) with key (CK-0) • Wt. 12½ Lbs

Unit Includes:

54 piece accessory kit rotating bur stand, mounted points, wire and bristle brush, sanding drums, assorted buffs, polishing wheels, compounds and flexshaft grease.

ITEM #	DESCRIPTION
34-1016	2230 KIT -110V / 60HZ
34-1017	2230 KIT -220V / 50HZ

3. SR Motor and Flexshaft + FCT (Speed Control)

- New flexshaft system from FOREDOM® with SR motors
 - SR ball bearing motor 1/8 hp, 18,000 rpm with forward and reverse switch
 - Handpiece to be ordered separately
- Wt. 11 Lbs

Note: Not for use with HP #30H and #44HT

ITEM #	DESCRIPTION
34-1021	SR MOTOR & SR-FCT 110V / 60HZ
34-1022	SR MOTOR & SR- FCT 220V / 50HZ
34-1023	SR MOTOR & SR-FCT + HANDPIECE 110V / 60HZ
34-1024	SR MOTOR & SR- FCT + HANDPIECE 220V / 50HZ
34-1026	#20 HANDPIECE

4. Electronic Foot Control

SCT:

- Wide base design and non-slip floor grip
- Speed controller in a metal body
- Solid state circuitry for continuous speed variation
- Not for use with models H, R, TX and TXH
- CSA Listed Wt. 6 lbs

FCT:

- Solid state, foot operated control
- High impact plastic housing, with skid resistant base
- Variable speed from low to high
- Not for use with models H, R, TX and TXH
- CSA Listed Wt. 2 lbs



ITEM #	DESCRIPTION
34-1031	SCT-1 /110V/ 60HZ
34-1032	SCT-2 /220V/ 50HZ
34-1035	FCT-1 / 110V / 60HZ
34-1036	FCT-2 / 220V / 50HZ

5. Flexible Shaft Motors

An all purpose, versatile unit that is the key to all model making, die finishing, wood carving, engraving and polishing. Ball bearing motor 1/10 hp, variable speed 0-18,000 rpm. Complete set includes motor, handpiece and foot control.



ITEM #	DESCRIPTION
34-1101	COMPLETE SET 110V / 60HZ
34-1102	COMPLETE SET 220V / 50HZ



6. Replacement Parts



ITEM #	DESCRIPTION
34-1251	INNER SHAFT-#93
34-1252	OUTER SHEATH-#77
34-1253	ARMATURE CC 110V*
34-1254	ARMATURE CC 220V*
34-1255	BRUSHES FOR "CC"-PAIR 119P
34-1256	BRUSHES FOR "SR"-PAIR 2019P
34-1257	HANDPIECE GRIP 630
34-1258	FOREDOM REPAIR KIT 9A
34-1259	OUTER SPRING COVER
34-1261	DUPLEX COMPLETE SET
34-1262	DUPLEX AXLE
34-1263	DUPLEX COLLAR SCREW
34-1264	S/SHAFT CONNECTOR
34-1265	QC SLEEVES
34-1266	DUPLEX COLLAR
34-1267	DUPLEX INNER SPRING
34-1268	DUPLEX DRIVE
34-1269	CONNECTOR
34-1271	OIL (HYPODERMIC) 10005
34-1272	GREASE (1 OZ TUBE) 10006

* Picture not shown

7. Marathon Micromotor

All purpose, versatile unit that is the key to all die finishing, wood carving, engraving and polishing. Powerful brushless motor design eliminates the need to replace brushes.

Control Unit: High torque - 7.8 N cm. at all speeds from 1000 to 50,000 rpm. Digital display for speed/torque settings. Variable speed regulation with auto-cruise, forward or reverse rotation.

Handpiece Motor :
6.3"long 0.51Ø at nose-wt. 8.4 oz.



Unit Includes:

- Control Unit
- Handpiece with 1/2" Collet
- Variable Speed Foot Control
- Handpiece Cradle
- Nose Guard
- Wrench

ITEM #	DESCRIPTION
34-1361	MARATHON MICROMOTOR COMPLETE 110/60HZ
34-1363	CONTROL UNIT - SDE-H 700
34-1364	MOTOR HANDPIECE- SDE-BH60
34-1368	FOOT PEDAL SDE-FS60N

8. Motor Hanger

Sturdy, steel arm motor stand that attaches firmly to your bench top with three screws. Adjustable height to suit all working positions.

ITEM #	DESCRIPTION
34-1281	ADJUSTABLE 26"-41"



9. Chuck Adapters

An accessory for holding small diameter tools. Adapter shank fits 3/32" quick release handpieces. Do not use with speeds higher than 10,000 rpm.



ITEM #	DESCRIPTION
34-1291	0-1.15MM- SMALL
34-1292	0-2.50MM- MEDIUM
34-1293	0-2.90MM- LARGE



FOREDOM® 10. Handpiece - #30

- General purpose, continuous duty handpiece
- One piece, light weight metal body with pre-lubricated ball bearings
- Protected Jacobs 3 jaw chuck to grip all tools with shanks up to $\frac{5}{32}$ "
- Includes chuck key



ITEM #	DESCRIPTION
34-1064	FOREDOM® HANDPIECE #30
34-1067	GEMS HANDPIECE #30 TYPE

FOREDOM® 11. Handpiece - #25C

- Jacobs chuck style handpiece
- Ideal for heavy duty work
- Accepts shank size up to $\frac{5}{32}$ "
- Supplied with chuck key



ITEM #	DESCRIPTION
34-1061	FOREDOM® HANDPIECE #25C

FOREDOM® 12. Hammer HP #15 & #15D

- A precision made affordable handpiece for stone setters
- Create textures, florentine, channel settings, close bezels and prongs
- Adjustable 5,000 stroke per minute with an impact hammer action
- Uses screw style tools, diamond pave and carbide points
- No warranty on duplex springs



ITEM #	DESCRIPTION
34-1055	FOREDOM® H/PIECE #15
34-1056	FOREDOM® H/PIECE #15D-DUPLEX

13. Handpieces QC- #40 Italy

- Superior quality, slim style, quick change handpiece
- Permanently sealed ball bearings, use for grinding and polishing works
- Flip type lever for a rapid tool change suitable for $\frac{3}{32}$ " shanks
- No warranty on duplex springs



ITEM #	DESCRIPTION
34-1161	HANDPIECE #40 STANDARD
34-1162	HANDPIECE #40 WITH DUPLEX

FOREDOM® 14. Handpiece - #35

- The ideal handpiece for diamond fly wheel tools and carbide points
- Speed max. 35,000 rpm
- Maximum flexshaft motor speed of 12,000 rpm
- Includes $\frac{1}{8}$ " collet with wrench • Collets for other sizes are available



ITEM #	DESCRIPTION
34-1068	FOREDOM® HANDPIECE #35

15. Chuck Keys

Two different types of chuck keys both fit Jacobs chuck 0- $\frac{5}{32}$ ".



ITEM #	DESCRIPTION
34-1065	CHUCK KEY WITH HANDLE
34-1066	CHUCK KEY ONLY

FOREDOM® 16. Handpiece QC #18 & #18D

- Impressive handpiece for the stone setter that has applications involving numerous tool changes • Quiet continuous operation, pre-loaded lubricated ball bearings and a rapid lock/release lever for tools with $\frac{3}{32}$ " shanks • No warranty on duplex springs

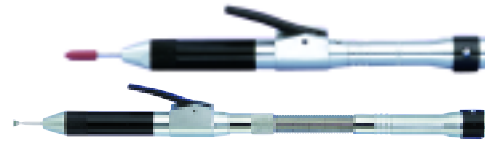

ITEM #	DESCRIPTION
34-1058	FOREDOM® H/PIECE #18
34-1059	FOREDOM® H/PIECE #18D-DUPLEX

17. Badeco® Rotary Handpiece - #437

- Quiet, vibration free model, with three super precision bearings to achieve a maximum speed up to 18,000 rpm
- Ingenious clamping and unclamping of tools by only a quarter turn of the body, eliminates the use of keys or spanners
- Unit is complete with $\frac{3}{32}$ " collet • No warranty on duplex springs



ITEM #	DESCRIPTION
34-1131	HANDPIECE #437
34-1132	HANDPIECE #437 WITH DUPLEX



18. Badeco® Hammer Handpiece

Dependable striking force makes this handpiece the #1 choice of the professional stone setter. Close bezels and prongs, design pave, texture and florentine. The duplex spring system offers complete maneuverability. Working speed 12,000 strokes per minute.

- No warranty on duplex springs

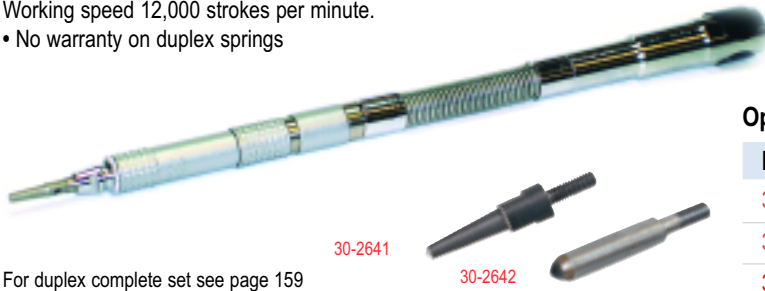

For duplex complete set see page 159

ITEM #	DESCRIPTION
34-1141	HEAVY STROKE-#217*
34-1142	HEAVY STROKE-#222*

* Supplied without duplex spring.

19. Pneumatic Air Scribe®

Combine air power (less than 1 cfm) with the Scribe and you have the flexibility to write on a variety of materials, even hardened steel. Super sharp carbide stylus will legibly mark all layouts, designs, and details with flawless accuracy. All that is needed is the addition of a clean air connection with a filter/lubricator/regulator. Comes with 8' reinforced hose.

Complete Set Includes:

- Handpiece • Diamond Tip • Air filter Assembly • Hose Assembly



ITEM #	DESCRIPTION
34-1171	AIR SCRIBE TOOL COMPLETE

20. Faro® Handpieces

Light weight one piece body with permanently lubricated, double sealed ball bearings. Quick tool change system provides real time savings. Comes with or without duplex connector and one 3/32" collet.

- No warranty on duplex springs

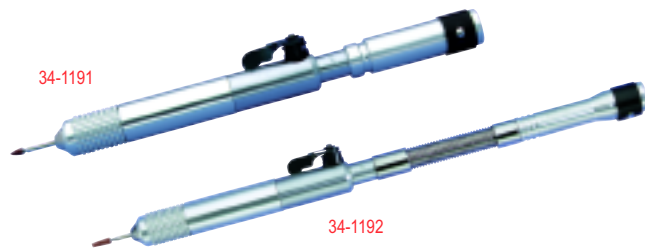

ITEM #	DESCRIPTION
34-1191	H/PIECE STANDARD MODEL
34-1192	H/PIECE WITH DUPLEX SPRING
34-1193	DUPLEX CONNECTION COMPLETE



Optional Accessories

34-1151

ITEM #	DESCRIPTION
34-1145	HAMMER TIP- 0.5MM ROUND ●
34-1146	HAMMER TIP- 1MM ROUND ●
34-1147	HAMMER TIP- 1MM SQUARE ■
34-1148	HAMMER TIP- 0.5 X 1MM OVAL ●
34-1151	SET OF 9 TIPS
30-2641	STANDARD POINT
30-2642	LASER POINT-DELUXE

Optional Accessories



ITEM #	DESCRIPTION
34-1172	FILTER ASSEMBLY FOR 34-1171
34-1173	REPLACEMENT DIAMOND TIP
34-1174	HOSE ASSEMBLY
34-1175	STYLUS ASSEMBLY
34-1176	AIR FOOT CONTROL
34-1177	REPAIR O-RING KIT
34-1178	REPAIR TOOLS DRIFT & HOLDER
34-1181	CHISEL ASSEMBLY SET (3 PCS)

21. Technique Handpieces- Swiss Type

34-1211: Rotary Handpiece with a single lever operation to open and close the collet, while the tool is still running. All metal dust proof casing. Includes 3/32" collet. Max. speed 18,000 rpm.

34-1212: Hammer Handpiece in a lightweight aluminum body with a hardened steel mechanism. Comes with one screw in tip. Max. speed 5,000 spm.

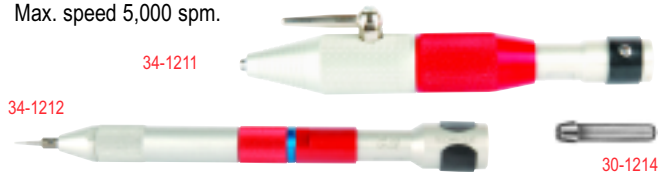

ITEM #	DESCRIPTION
34-1211	TECHNIQUE QC HANDPIECE- 3/32" #1025
34-1212	TECHNIQUE HAMMER HANDPIECE #1027
34-1213	REPLACEMENT COLLET- 3/32"
34-1214	REPLACEMENT COLLET- 1/8"
34-1215	REPLACEMENT HAMMER TIP



35,000 rpm - Set includes controller, foot on/off switch, handpiece($\frac{3}{32}$ " collet) and stand.



45,000 rpm : Set includes controller, foot speed control, handpiece($\frac{3}{32}$ " collet) and stand.



Standard Set Includes:

- Control Unit • Handpiece (Attachment with Motor)
- QC Chuck with collets($\varnothing 3$ & $\varnothing 2.35$ mm) • Handpiece Stand
- Spanner (7 X 5.1mm) • Pin Spanner

E-max foot control and gear reducer not included.
Handpiece comprises of attachment (Ring or Lever type) with motor.



Standard Set Includes:

- Control Unit • Handpiece • Collets $\frac{1}{16}$ " & $\frac{3}{32}$ "
- Handpiece holder • Wrench and pin wrench
- Dimensions: 6.77" X 9.06" X 3.7"

22. Power Micromotors

High-Powered 35,000rpm

- Specifications:** • Forward/Reverse operation • Dual Voltage 110/220V
• Automatic overload protection system • Dimensions: 108 x 131 x 77 mm Wt: 3.5 lbs

ITEM #	DESCRIPTION	\$ / EA
34-1381	HIGH POWERED 35,000 SET 204-102WL	299.00
34-1383	HANDPIECE $\frac{3}{32}$ " COLLET-35,000 RPM	165.00
34-1384	FOOT ON/OFF SWITCH	20.00

High-Powered 45,000rpm

- Specifications:** • Forward/Reverse operation • Dual Voltage 110/220V
• Automatic overload protection system • Dimensions: 120 x 154 x 72 mm Wt: 5 lbs

ITEM #	DESCRIPTION	\$ / EA
34-1391	HIGH POWERED 45,000 SET 202N-110WL	379.00
34-1393	HANDPIECE $\frac{3}{32}$ " COLLET-45,000 RPM	165.00
34-1394	FOOT SPEED CONTROL	40.00

23. E-max High Speed Standard Set (Ring Type)

An ultra-precision rotary handpiece system that is user friendly. Features a digital display, a built in switch on the handle and an innovative vertical tower case which allows less footprint. Using an advanced coreless DC motor technology the E-max handpiece is smaller, lightweight and easier to maneuver. Increase the torque up to four times by addition of the speed reducer. This high torque and precise speed control gives goldsmiths the power for shaping, finishing and diamond fly-cutting.

Specifications:

- Rotation Speed: 1,000-35,000 rpm
- Output Power: 71W
- Power Source: 110V/ 60Hz
- Maximum Torque: 4.1N cm
- Power Consumption: 30W

ITEM #	DESCRIPTION
34-1330	E-MAX HIGH SPEED STD. SET-EL351C-IR12
34-1332	E-MAX MOTOR WITH CORD NK351
34-1334	REDUCTION GEAR 4:1 -RG-01
34-1336	E-MAX FOOT PEDAL FC-40
34-1339	E-MAX ATTACHMENT RING TYPE IR-310

Attachments available. Lever Type IH-300 (34-1333) and Hammer Type HA500 (34-1337)

24. Espert 500 Standard Set (Ring Type)

Compact lightweight model with a high standard in overall excellence. A microcomputer integrated controller sets the variable speed from 1000 to 50,000 rpm. The state of the art brushless motor with cooling fan results in smooth, quiet, vibration free operation. Features an ergonomic handpiece with patented dust proof protection, self-check maintenance, mode and error code display function.

ITEM #	DESCRIPTION
34-1341	ESPERT 500 STAND. SET ES50C-HR 110V/ 60HZ
34-1342	ESPERT 500 CONTROL UNIT NE96
34-1343	REDUCTION GEAR 4:1 -ERG-01B
34-1344	COMPACT MOTOR HANDPIECE ENK50C-HR

Attachments available. Ring type EHR-500 (34-1345), Lever Type EHL-401 (34-1346) and Motor with cord ENK500C (34-1347)



GAUGES

■ Accurate Diamond Gauge	166
■ Aluminum Ring Sticks	170
■ Baker Gauge	165
■ Bezel Mandrels	170
■ Bracelet and Ring Sizers- Wooden	170
■ Bracelet Gauge	165
■ Bracelet Mandrels	170
■ C-Master Jewelry Gauge	166
■ Degree Gauges- France	166
■ Degree Gauges -German	169
■ Deluxe Ring Sizer	167
■ Diamond Gauge	167
■ Diamond/Pearl Gauge	164
■ Digimatic Caliper	165
■ Digital Gauge	167
■ Dividers with Square Legs	165
■ Drill Gauges	167
■ Fan Type Diamond Gauge	164
■ Flexible Ruler	168
■ Half Round Finger Sizer	164
■ Hi-Impact Dial Caliper	166
■ Jo-Di Gauge	168
■ Jumbo Finger Sizer	169
■ Jumbo Steel Ring Mandrel	166
■ K & B Diamond Gauge	166
■ Leveridge Type Gauge	168

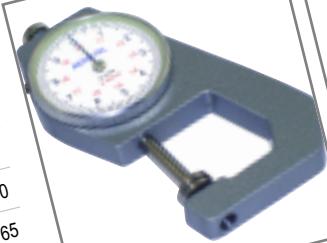

■ Micrometer	168
■ Mitutoyo Digimatic Caliper	164
■ Moe Type Degree Gauge	166
■ Pearl & Stone Dial Gauges	167
■ Plastic Finger Sizer	168
■ Plastic Ring Stick	169
■ Pocket Degree Gauges	166
■ Pocket Digital Gauge	165
■ Presidium® Gauges	168
■ Quick Mini Digital Gauge	165
■ Ring Sticks Lightweight	170
■ Sliding Gauges	164
■ Standard Flat Bands	168
■ Starrett® Dividers with Round Legs	166
■ Steel Bracelet Mandrels with Tang	169
■ Steel Ring Mandrels	169
■ Steel Vernier Caliper	164
■ Stone Millimeter Dial Gauges	167
■ Universal Ring Stick	169
■ Wide Band Finger Sizer	168
■ Wire Steel Gauge-USA	165



 **Ikohe**

Mitutoyo
PRESIDIUM



Practical Jewelry Making

by **Loosli/Merz/Schaffner**

A comprehensive book providing practical, instructional knowledge for proficiency in the jewelry trade. Extensive coverage of basic operations including filing, sawing, soldering and drilling. Complex forming, assembling, setting and finishing operations are also covered.

61-1019 (Hardcover - 164 pages)



1. Sliding Gauges

Convenient pocket sized sliding gauges in alloy, brass and plastic. Clear machine divided graduations. Useful for quick outside measurements in inch /metric of small parts or stones.

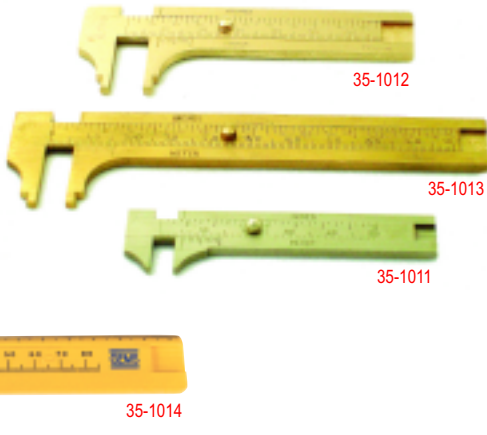

ITEM #	DESCRIPTION
35-1011	SLIDE GAUGE ALLOY 50MM - GERMANY
35-1012	SLIDE GAUGE BRASS 60MM - GERMANY
35-1013	SLIDE GAUGE BRASS 80MM - GERMANY
35-1014	SLIDE GAUGE PLASTIC 80MM - SWISS

3. Hi-Impact Dial Caliper

Made of high impact nylon, its lightweight elegant design makes it convenient for a variety of general applications. Features an accurate dial reading display inch/metric.



ITEM #	DESCRIPTION
35-1021	DIAL CALIPER -150MM/ 6"

5. Steel Vernier Caliper

A general purpose stainless steel vernier, with smooth sliding jaws, calibrated in both inch and metric measurements. Three way readings are possible: inside, outside and depth. Resolution 0.01mm.



ITEM #	DESCRIPTION
35-1022	STEEL VERNIER -150MM/ 6"

Mitutoyo 2. Digimatic Caliper

An innovation in electronic measuring, this caliper uses high efficiency sensor technology. Engineered in hardened stainless steel for stability and durability. Features a digital readout in both inch/metric, resolution 0.0005"/0.01mm, with hold and zero functions. Additional hold down screw locks the jaw in position. Inside, outside and depth readings are possible.

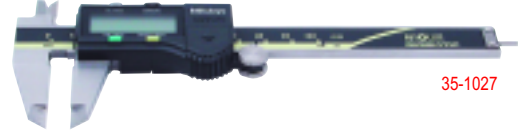

ITEM #	DESCRIPTION
35-1026	DIGIMATIC CALIPER -150MM / 6"
35-1027	DIGIMATIC CALIPER -100MM / 4"
35-1028	DIGIPA CALIPER -150MM/ 6"

4. Digital Caliper- Value

An affordable digital vernier made in tough reinforced fiberglass. Exclusive thumb grip sliding jaw for rapid reading digital display. For inside or outside measurements in either inch or metric readings. Includes a zero reset function. Resolution 0.1mm.



ITEM #	DESCRIPTION
35-1023	DIGITAL CALIPER VALUE -100MM/ 4"
35-1024	DIGITAL CALIPER VALUE -150MM/ 6"

6. Flexible Ruler

Indispensable for general layout work, these flexible stainless steel rulers have micro fine etched graduations that will not wear away. Markings in inches and millimeters, by 1/64" and 0.5mm.



ITEM #	DESCRIPTION
35-1016	FLEXIBLE RULER -6" / 15 CM



7. C-Master Jewelry Gauge

A compact, highly accurate, digital gauge for easy stone measurement. The unit is provided with a twin gauge head that measures both inside and outside. Features automatic calculation of caratage. Measures from melee to taper with maximum reading of 25mm/1" .



ITEM #	DESCRIPTION
35-1155	C-MASTER JEWELRY GAUGE 0-25MM

8. Quick Mini Digital Gauge

An ingenious measuring device designed and crafted to the most exacting standards. Lightweight, ergonomic body, with large measuring faces, useful for both thick and thin parts. Clear digital readout with a maximum reading of 25mm/1" and a resolution of 0.01mm/ 0.0005".



ITEM #	DESCRIPTION
35-1151	QUICK MINI DIGITAL GAUGE 0-25MM/1"

9. Pocket Digital Gauge

Precision pocket digital caliper with LCD display and zero re-set button. Maximum reading 25mm. Resolution 0.01mm.



ITEM #	DESCRIPTION
35-1157	POCKET DIGITAL GAUGE 0-25MM/1"

10. Digital Gauge

A high precision palm sized digital gauge, with a super smooth sliding anvil. Gives a clear digital display in both inch or metric readings. Includes a zero re-set button. Maximum reading 25mm .



ITEM #	DESCRIPTION
35-1159	DIGITAL GAUGE- 0-25MM/1"

11. Drill Gauges

Made of heat treated heavy gauge steel to close tolerances. Hole sizes and decimal equivalents are etched on the face.

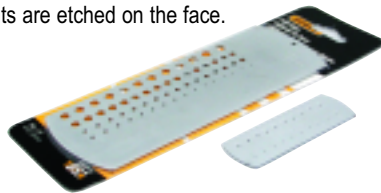

ITEM #	NUMBER SIZE
31-1995	DRILL GAUGE #1-60
31-1996	DRILL GAUGE #61-80

12. Bracelet Gauge- France

An economical strap type gauge that easily adjusts to measure bracelets or other wrist jewelry. Calibration in 1/4" increments.



ITEM #	DESCRIPTION
35-1045	BRACELET GAUGE 5"-9"

13. Wire Steel Gauge-USA

Made of heavy gauge hardened and tempered steel and useful for measuring all wire and sheets of ferrous or non-ferrous metal. Calibrated in gauge numbers as well as decimals.

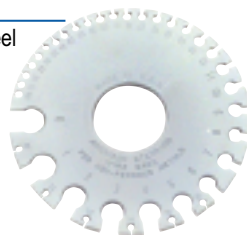

ITEM #	DESCRIPTION
35-1032	WIRE STEEL GAUGE 0-36 GA

14. Baker Gauge

The holes in this gauge are used to measure stones and the extensions are used to measure mountings. Gauge has millimeter and carat measurements.



ITEM #	DESCRIPTION
35-1044	BAKER GAUGE



15. Degree Gauges - France

High precision degree gauges superbly constructed in extra fine quality steel. Graduations on a glare free surface ensure accurate readings. The combination degree gauge measures in both millimeters and lignes. Range 15mm and 6 lignes. 6 1/2" in length.



ITEM #	DESCRIPTION
35-1051	DEGREE GAUGE SINGLE-1/10MM
35-1052	DEGREE GAUGE COMBINATION

16. Pocket Degree Gauges

Lightweight, sensitive, stainless steel gauge for measurements up to 10mm with easy to read indices. Wax gauge has rounded points. Steel gauge has sharp points. Overall length 4".



ITEM #	DESCRIPTION
35-1057	DEGREE GAUGE FOR WAX- 10MM
35-1058	DEGREE GAUGE FOR STEEL - 10MM

17. Moe Type Degree Gauge

A convenient way for quick estimates of carat weight without the need to remove stones from their settings. Measurement of the girdle diameter with a cross reference chart will indicate the weight.



ITEM #	DESCRIPTION
35-1060	DEGREE GAUGE

18. Degree Gauges -German

Precision degree gauges in stainless steel with contrasting brass indices to enhance readability. Superior construction with return spring action ensures perfect accuracy.

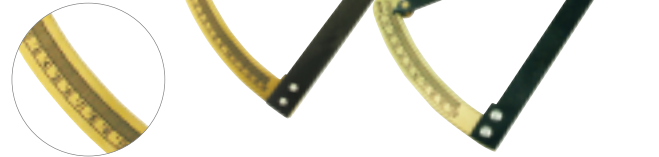

ITEM #	DESCRIPTION
35-1054	0-10mm / 0.1mm -SMALL 4"
35-1055	0-15mm / 0.1mm -LARGE 6 1/2"

19. Starrett® Dividers -Round Legs

Highly polished dividers made of spring steel with hardened, tempered and well balanced round legs. Floating washer and thumb screw allows fast and precise adjustment.

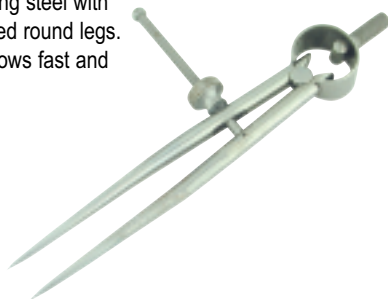

ITEM #	DESCRIPTION
35-1034	DIVIDER 3" ROUND LEGS

20. Jo-Di Gauge

Unique international sizing system. Measures diameter and width of four basic shapes: round, marquise, emerald and pear. High contrast black anodized scale readings are to be compared with the reference booklet. Comes in a handy wallet.



ITEM #	DESCRIPTION
35-1068	JO-DI GAUGE SET

21. Accurate Diamond Gauge

Pocket sized, aluminum gauge, provides the comparative size of gemstones in carats. Size range is 1 point to 2.1 carats. Estimates round, brilliant cuts and baguettes.



ITEM #	DESCRIPTION
35-1041	ACCURATE DIAMOND GAUGE

22. K & B Diamond Gauge

Flat, tempered aluminum pocket gauge measures loose or mounted stones ranging from three points to 4 carats. Handy birthstone chart on the back.

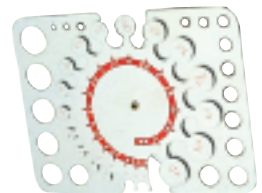

ITEM #	DESCRIPTION
35-1042	DIAMOND GAUGE



23. Dividers - Square Legs

Heavy duty hardened and tempered steel with square legs that will not flex or bend. Sturdy spring pivot and a centrally located fine adjustment screw ensures precise setting over the entire range.



ITEM #	DESCRIPTION
35-1035	DIVIDER 2½" - FRANCE
35-1036	DIVIDER 3" - GERMAN
35-1037	DIVIDER 3" REPLACEABLE POINTS
35-1038	SPARE POINTS FOR 35-1037
35-1039	DIVIDER 4" - GERMAN

25. Diamond/Pearl Gauge

An efficient, accurate plastic gauge for determining the size of loose or mounted stones when other methods are unavailable. Clearly marked numbers provide instant estimates.

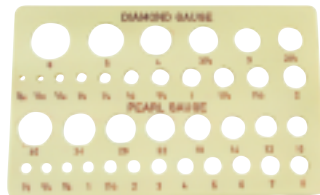

ITEM #	DESCRIPTION
35-1049	DIAMOND / PEARL GAUGE

27. Pearl & Stone Dial Gauges

A sensitive, precision engineered dial gauge for accurate measurements of pearls and other small stones. Parallel ground measuring faces for rounds and baguettes in 0.1mm increments. Dial rotates for absolute zero setting.



ITEM #	DESCRIPTION	CAPACITY
35-1161*	S/DIAL GAUGE-GERMANY	10MM
35-1162	S/DIAL GAUGE-GERMANY	20MM
35-1165	S/DIAL GAUGE-VALUE	10MM
35-1166	S/DIAL GAUGE-VALUE	20MM

* PICTURE NOT SHOWN

24. Fan Type Diamond Gauge

Compact, fan type, pocket gauge in stainless steel. Measures in carat weight all stone cuts in brilliant, marquise, pear, square, emerald and oval. Overall length 3½".

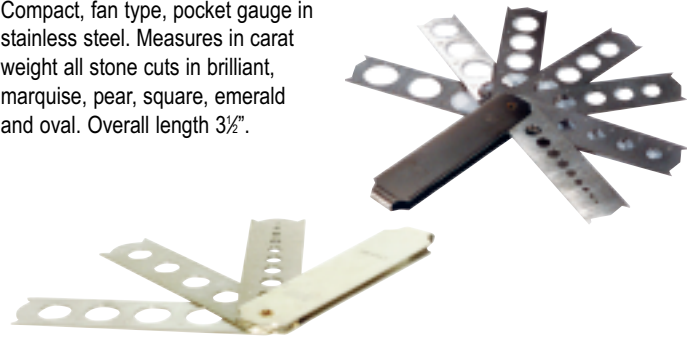

ITEM #	DESCRIPTION	CARAT
35-1061	3 ARMS ROUND-FRANCE	0.1 TO 4
35-1062	4 ARMS ROUND-FRANCE	0.1 TO 6
35-1063	7 ARMS ASSORTED-USA	0.1 TO 8

26. Diamond Gauge - France

Polished steel gauge, in either oval or rectangular shape. Determines the carat weight of loose or mounted stones, from 1 point to 4 carats. Embossed marked sizes for easy reading.

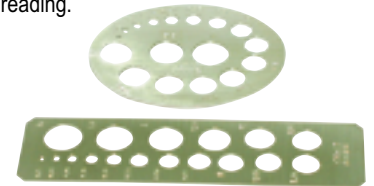

ITEM #	DESCRIPTION
35-1047	5CM -OVAL
35-1048	9 X 205CM -RECTANGLE

28. Stone Millimeter Dial Gauges

A well designed gauge that provides an easy measuring system for single hand operation. Precision parallel measuring faces for rounds and baguettes in 0.1mm increments up to a maximum of 10mm. Dial rotates for absolute zero setting.



ITEM #	DESCRIPTION
35-1168	MILLIMETER DIAL GAUGE 0.1-10MM

For Gauges
see page # 122



29. Micromat Leveridge Type Gauge -USA

The most versatile measuring instrument for any jewelry appraiser or gem cutter. Estimates weight of diamonds mounted or loose. May also be used for other precious gems and pearls. Comes with high setting attachment and weight estimator. Includes an inside measuring system for rings. Precision crafted for years of service.



ITEM #	DESCRIPTION
35-1141	MICROMAT LEVERIDGE TYPE GAUGE
35-1142	BOOK & CASE

31. Micrometer

An outside micrometer of the finest quality with a measuring range in inch and mm. Distinct figures and graduations on a non glare background permit easy reading. Measuring faces are hardened and precision ground. Friction thimble and positive lock lever ensure reliable measurements.



ITEM #	DESCRIPTION
35-1017	MICROMETER 0-25MM
35-1018	MICROMETER 0-1"

33. Standard Flat Bands

Convenient, easy to use, accurate US standard sizes # 1- 15 including half sizes. Each band is clearly marked and colored for easy reading.



ITEM #	DESCRIPTION
35-1073	STANDARD FLAT BANDS

35. Wide Band Finger Sizer

A complete set of wide band ring sizers in bright nickel plated brass, each individually smooth finished. Sizes #1-15 including half sizes. Ideal for wedding band ring measurements.



ITEM #	DESCRIPTION
35-1077	WIDE BAND FINGER SIZER

30. Presidium® Gauges

Presidium® Dial Gauge:

Predictable accuracy. Read out measurement in millimeters and weight in carats simultaneously. Measures stones up to 23 mm in divisions of 0.1mm. Hardened wear resistant measuring surfaces. Includes a conversion booklet and a carrying case.



Presidium® Digital Gemstone Gauge:

Hi-tech, solid state circuitry eliminates miscalculation and gives direct digital read out up to one micron accuracy. Features include long life battery, zero reset and auto-off. Unsurpassed value for the discriminating jeweler.



ITEM #	DESCRIPTION
35-1146	DIAL GAUGE 0-23MM
35-1147	DIGITAL GEM STONE GAUGE 0-23MM
35-1148*	GEM COMPUTER GAUGE 0-25MM

* See page 122 for details

32. Plastic Finger Sizer

An economical ring sizer in plastic, #1-13 with half sizes.

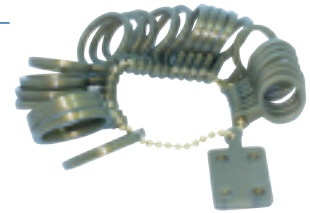

ITEM #	DESCRIPTION
35-1071	PLASTIC FINGER SIZER

34. Half-Round Finger Sizer

Extremely comfortable for measurements, the inside of these ring sizers are half round to facilitate easy on and easy off. Includes US standard sizes #1-13 with half sizes, marked and colored for easy reading.



ITEM #	DESCRIPTION
35-1074	HALF-ROUND FINGER SIZE

36. Jumbo Finger Sizer

A set of five larger than ordinary ring sizers made in polished nickel plated brass. Sizes include 14, 14½, 15, 15½ & 16.



ITEM #	DESCRIPTION
35-1078	JUMBO FINGER SIZER



37. Deluxe Ring Sizer

A customer-friendly way to check ring sizes. 34 individual rings from size 000-16 by half size. All rings are 6mm wide, individually calibrated, together with a universal ring stick, displayed in an attractive storage box. Includes a conversion chart for American, English, and French sizes.



ITEM #	DESCRIPTION
35-1092	WIDE BAND
35-1093	REGULAR

39. Plastic Ring Stick

Made of hard plastic, this ring stick provides precise and accurate measurements. Markings are legible and indicate sizes #1-15 in 1/4 size increments.



ITEM #	DESCRIPTION	SIZE
35-1081	PLASTIC GROOVED MANDREL	#1-15

41. Steel Ring Mandrels

These hardened and polished steel mandrels are especially useful for shaping and forming rings. Accommodates all ring sizes #1-15 in 1/4 size increments.



ITEM #	DESCRIPTION	SIZE
35-1088	RING MANDREL - REGULAR	#1-15
35-1089	RING MANDREL - GROOVED	#1-15

38. Steel Bracelet Mandrels with Tang

Shape, stretch or form bracelets using these tough polished cast iron mandrels.

Stepped Mandrels: Available in round or oval forms, with 1 3/4" tangs for holding in a vise.
Oval Stepped: 2", 2 1/4", 2 1/2", 2 3/4"
Round Stepped: 1 3/4", 2", 2 1/2", 2 3/4"



Tapered Mandrels: Available in round or oval forms, smooth taper. Tang is 1 3/4" long.
Oval Taper: 1 3/4" x 2 1/2" to 2 1/2" x 2 3/4"
Round Taper: 3" to 2"

ITEM #	DESCRIPTION
35-1106	STEPPED -OVAL
35-1107	STEPPED -ROUND
35-1108	TAPERED -OVAL
35-1109	TAPERED -ROUND

40. Universal Ring Stick

A ring stick fashioned from lightweight aluminum with an integral handle. Measures in US and European ring sizes and shows both diameter and circumference in millimeters. Calibrated in US sizes #2-15 in 1/4 size increments.

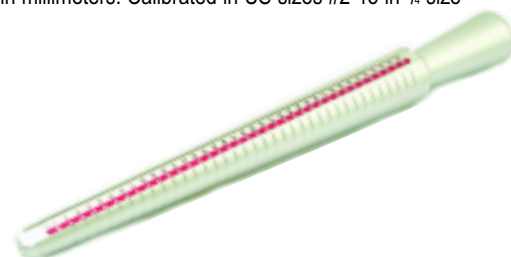

ITEM #	DESCRIPTION	SIZE
35-1082	UNIVERSAL RING STICK	#2-15

42. Jumbo Steel Ring Mandrel

This extra large size mandrel accommodates sizes 16 to 24 in 1/4 size increments. It is provided with a knurled hand grip and is practical for use on custom designed jewelry. Overall length 8".

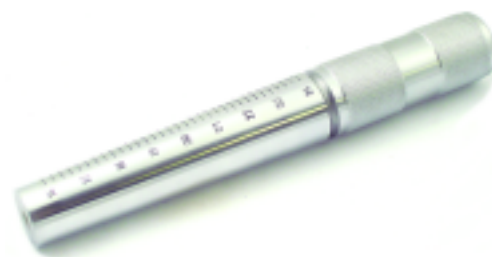

ITEM #	DESCRIPTION	SIZE
35-1091	JUMBO STEEL MANDREL	#16-24



43. Aluminum Ring Sticks

A durable, economical solid aluminum ring stick in two versions, regular or grooved for stone set rings. Measures # 1-15 in 1/4 size increments.



ITEM #	DESCRIPTION	SIZE
35-1084	RING STICK -REGULAR	#1-15
35-1085	RING STICK -GROOVED	#1-15

44. Ring Sticks -Lightweight

Elegantly finished, tubular nickel plated ring stick is extra lightweight and provided with a shaped redwood handle for comfort. Ideal for wax working as the hollow tube does not retain heat. The grooved style is for measuring stone set rings.



Measures sizes #1-15 in 1/4 size increments.

ITEM #	DESCRIPTION	SIZE
35-1086	RING STICK -REGULAR	#1-15
35-1087	RING STICK -GROOVED	#1-15

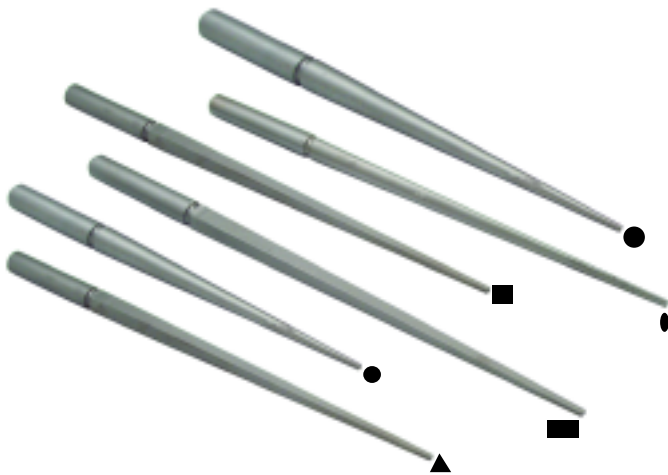

45. Bezel Mandrels

Quite simply, the fastest way to form bezels in different shapes. May also be used to make decorative wire forms. These mandrels are made of case hardened steel, precision finished and polished. Mandrel portion is approx. 8" long with a 1/2" to 1/8" taper.

ITEM #	SHAPE	LENGTH
35-1121	ROUND	8"
35-1122	ROUND	11"
35-1123	SQUARE	11"
35-1124	RECTANGLE	11"
35-1125	TRIANGLE	11"
35-1126	OVAL	11"

46. Bracelet and Ring Sizers- Wooden

Bracelet sizer: High quality polished wood sizer has three cutting edges to ream and shape bracelets to size- measures circumference from 5 to 8.5" with millimeter equivalent.

Ring sizer: Designed for precision reaming of wax forms to exact sizes in US/ Euro /mm sizes from #1-14 including half sizes.



ITEM #	DESCRIPTION
59-5121	BRACELET SIZER
59-5122	RING SIZER -USA
59-5123	RING SIZER -EUROPEAN

47. Bracelet Mandrels

These mandrels are adaptable for shaping, stretching, and forming bracelets. Exterior surface is smoothly polished. Available in round and oval shapes.

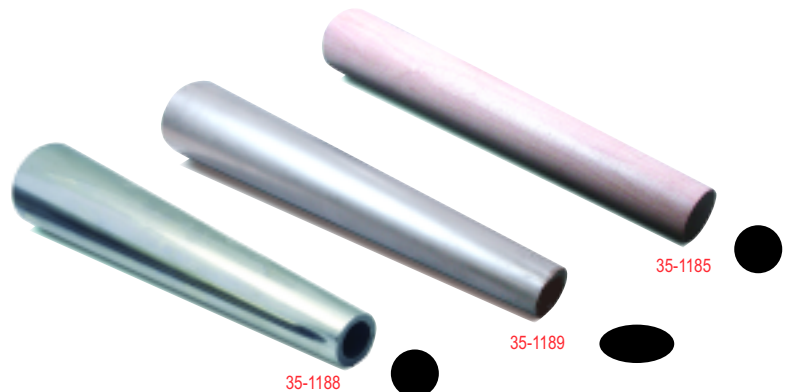

ITEM #	DESCRIPTION
35-1185	ROUND- 1 1/2" X 3 1/2" X 15"L -WOOD
35-1186*	OVAL (1 1/8"/1 1/8") X (3"/3 1/2") X 15"L -WOOD
35-1188	ROUND 1 1/2" X 3 1/2" X 15"L -STEEL
35-1189	OVAL (1 1/8"/1 1/8") X (3"/3 1/2") X 15"L -STEEL

* Picture not shown



Professional Series - DL Scope



• **GIA Designed** • Model 845000- 6x to 45x • Model 864500- 10x to 64x

- Electrically noise free lighting environment
- GIA patented Darkfield and Brightfield Illumination
- Variable intensity control
- Stable illumination, void of spikes, flickers or yellowish color changes
- Two strategically designed illumination ports
- Automatic 110V-240 voltage

Ergonomics

- Clear digital lighting substantially reduces eye fatigue
- Swivel base with patented stationary power cord eliminates tangles
- Wider work stage for optimum hand comfort
- Ergonomically designed adjustable base promotes proper posture for viewing

ITEM #	DESCRIPTION
36.1011	STEREOZOOM MAGNIFICATION RANGE 6X TO 45X
36.1012	STEREOZOOM MAGNIFICATION RANGE 10X TO 64X

Accessories Included :

- Wire stone holder
- Eyeguards
- Dust cover
- User guide

GEMOLOGICAL INSTRUMENTS



GIA
GEMOLOGICAL INSTITUTE OF AMERICA
Instruments



Research Series - DL Scope



• GIA Designed • **Model 964500- 10x to 64x**

- Electrically noise free lighting environment
- GIA patented Darkfield and Brightfield Illumination
- Variable intensity control with LCD readout
- Stable illumination, void of spikes, flickers or yellowish color changes
- Three strategically designed illumination ports
- Automatic 110V-240 voltage

Ergonomics

- Clear digital lighting substantially reduces eye fatigue
- Swivel base with patented stationary power cord eliminates tangles
- Wider work stage for optimum hand comfort
- Ergonomically designed adjustable base promotes proper posture for viewing

ITEM #	DESCRIPTION
36-1015	STEREOZOOM MAGNIFICATION RANGE 10X TO 64X

GEMOLOGICAL INSTRUMENTS

- Accessories Included :**
- Wire stone holder
 - Eyeguards
 - Dust cover
 - User guide



Presentation Series

• GIA Designed • Model 910000-10x



- Darkfield illumination
- Iris diaphragm for illumination control
- Overhead spot illumination
- Stoneholder
- Designed for 110v and 220v use

ITEM #	DESCRIPTION
36-1021	MAGNIFICATION RANGE 10X



GIA
GEMOLOGICAL INSTITUTE OF AMERICA
Instruments

Overhead Light Source

• GIA Designed • Model 930100



- Simulates north facing light for accurate color grading
- View facets and surface graining better with reflected light
- Essential for opaque and darker translucent stones
- Detect synthetics and enhancements easier

ITEM #	DESCRIPTION
36-1018	OVERHEAD LIGHT SOURCE

LED Incident Light Source

• GIA Designed • Model 930200



- Variable light operates independent from darkfield and brightfield lamp
- Direct horizontal or oblique angle light
- Observe thin-film effects such as iridescence in liquid inclusions and in tiny cleavages

ITEM #	DESCRIPTION
36-1019	LED INCIDENT LIGHT SOURCE



DiamondDock

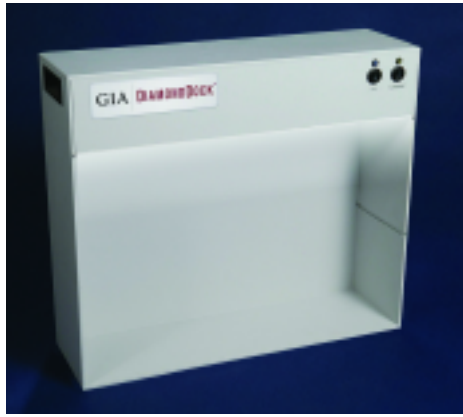

• GIA Designed • Model 155000

- Combines fluorescent and calibrated LED lighting
- Provides the optimal lighting for assessing the cut quality of brilliant cut diamonds, as well as other cuts
- Custom diamond trays allow for ease of viewing and comparing multiple diamonds
- Chromatically optimised GIA Trulight fluorescent lighting
- Automatic 100-240 voltage

ITEM #	DESCRIPTION
36-1031	DIAMONDDOCK
36-1032	REPL. BULB 110V

DiamondLite

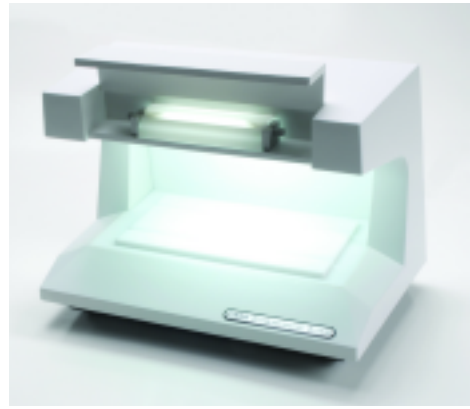

• GIA Designed • Model 180000

- Balanced diffused cool white light
- Translucent tray adjusts to reduce reflection from facets
- Built-in long wave ultraviolet lamp works with diamonds and colored stones

ITEM #	DESCRIPTION
36-1041	DIAMONDLITE
36-1042	REPL. BULB 110V

Duplex II Refractometer



• GIA Designed • Model 392000

- Designed to "spot" read cabochons or small facets with diameters less than 1 mm
- Top of the line model with magnifier that enlarges RI scale image
- Polarizing filter and RI liquid included

ITEM #	DESCRIPTION
36-1051	REFRACTOMETER
36-1052	RI LIQUID 10G

Illuminator Polariscope

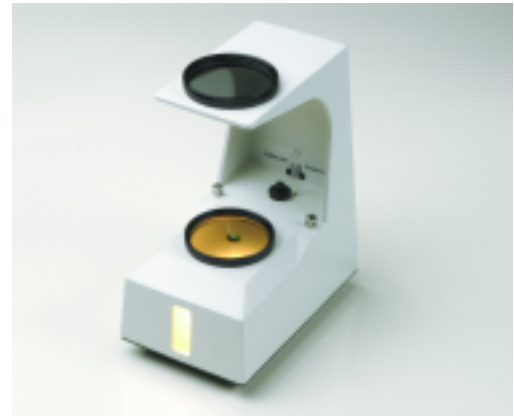

• GIA Designed • Model 415000

- A fast way to test the optical properties of gemstones
- Resolve optic character in doubly refractive gems and detect diamond strain
- Optical stone holder mounts on both sides. Operates on 110V and 220V with user chargeable bulb

ITEM #	DESCRIPTION
36-1061	POLARISCOPE
36-1062	REPL. BULB 110V
36-1063	REPL. FIGURE SPHERE



GRAVERS



Adjustable Graver Handle	181	High Speed Gravers - Yellow Tang	177
Adjustable Graver Handle Set	181	High Speed Gravers- Pre-Shaped	182
Crocker Pattern-Graver Sharpener	181	High Speed Gravers- Red Tang	182
E.C. Muller® Gravers	176	Multi-Purpose Tool Holder	181
E.C. Muller® Straight & Bent L/Gravers	177	NTG - New Traditional Gravers	179
Graver Handles- Thermo Loc	178	QC - Quick Change Gravers- HSS	178
Graver Sharpeners	181	TG - Traditional Gravers	180
GRS® Burnishing Tools	180		
GRS® Glensteel Gravers	180		
GRS® Hand Chuck	178		
GRS® Heat Treated Steel Points	179		
GRS® Line Gravers	178		
GRS® Tungsten Carbide Gravers	178		
GRS® Tool Organizers	181		



Jewelry Engravers Manual #022-202

by **R. Allen Hardy and John J. Bowman**
 This book concentrates on jewelry engraving, with special emphasis on lettering, monogramming and ring engraving. Use of tools and proper work techniques are clearly described so you can learn to hand engrave jewelry yourself.
61-1114 (Softbound - 143 pages)

ikohe

GLARDON
VALLORBE

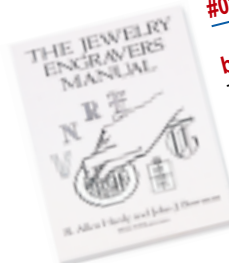

GRAVERS



1. E.C. Muller® Gravers- USA

High Speed: These gravers hold an edge up to five times longer than carbon steel gravers. Preferred for use on silver, gold, platinum and steel. May be modified for use with power assisted engraving systems.

Carbon Steel: Made of high grade steel. Suitable for use on metals such as copper, silver, gold and other alloys.

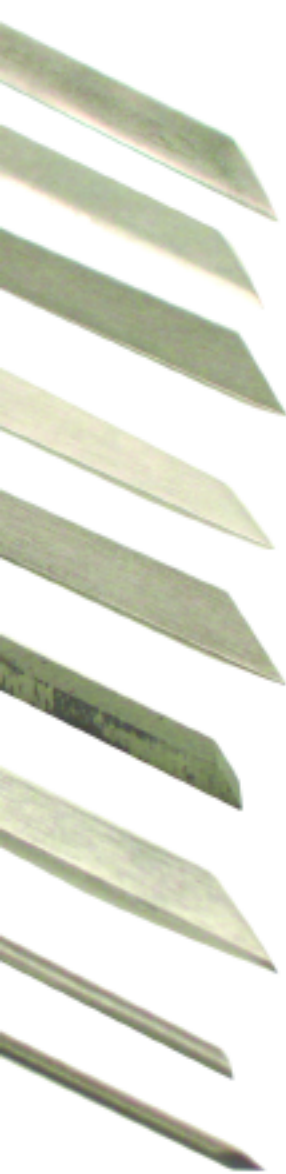

ONGLETTE

SIZE	CARBON STEEL	HSS
3/0	37-1008	37-1198
2/0	37-1009	37-1199
0	37-1010	37-1200
1	37-1011	37-1201
2	37-1012	37-1202
3	37-1013	37-1203
4	37-1014	37-1204
5	37-1015	37-1205
6	37-1016	



ROUND

SIZE	CARBON STEEL	HSS
50	37-1050	37-1250
51	37-1051	37-1251
52	37-1052	37-1252
53	37-1053	37-1253
54	37-1054	37-1254
55	37-1055	37-1255
56	37-1056	37-1256
57	37-1057	37-1257
58	37-1058	37-1258
59	37-1059	37-1259



FLAT

SIZE	CARBON STEEL	HSS
36	37-1036	37-1236
37	37-1037	37-1237
38	37-1038	37-1238
39	37-1039	37-1239
40	37-1040	37-1240
41	37-1041	37-1241
42	37-1042	37-1242
43	37-1043	37-1243
44	37-1044	37-1244
45	37-1045	37-1245



KNIFE

SIZE	CARBON STEEL	HSS
0	37-1020	37-1210
1	37-1021	37-1211
2	37-1022	37-1212
3	37-1023	37-1213
4	37-1024	37-1214



BEVEL

SIZE	CARBON STEEL	HSS
0	37-1060	37-1260
1	37-1061	37-1261
2	37-1062	37-1262
3	37-1063	37-1263
4	37-1064	
5	37-1065	



LOZENGE

SIZE	CARBON STEEL
0	37-1070
1	37-1071
2	37-1072
3	37-1073
4	37-1074
5	37-1075
6	37-1076
7	37-1077
8	37-1078
9	37-1079
10	37-1080

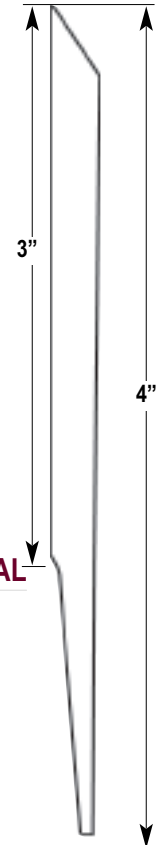

TAPER SQUARE

SIZE	CARBON STEEL
1	37-1091
2	37-1092
3	37-1093



SQUARE

SIZE	CARBON STEEL
0	37-1120
1	37-1121
2	37-1122
3	37-1123
4	37-1124
5	37-1125
6	37-1126
7	37-1127
8	37-1128
9	37-1129
10	37-1130



TAPER LOZENGE

SIZE	CARBON STEEL
1	37-1111
2	37-1112
3	37-1113



OVAL

SIZE	CARBON STEEL
63	37-1143
64	37-1144
65	37-1145
66	37-1146
67	37-1147



Graver handles
see page# 181



GRAVERS

2. E.C. Muller® Straight & Bent Line Gravers

E.C. Muller® Line gravers are essential for performing various engraving techniques. The first number is the grade. For reference #6 is the smallest #32 is the largest. The second number is the number of lines that can be engraved at a time.



STRAIGHT LINE

WIDTH / # OF LINES	HIGH CARBON
6/4	37-2111
6/6	37-2112
6/8	37-2113
6/10	37-2114
6/18	37-2118
8/4	37-2121
8/6	37-2122
8/8	37-2123
8/10	37-2124
12/6	37-2142
12/8	37-2143
12/10	37-2144
12/12	37-2145
12/16	37-2147
14/10	37-2154
16/4	37-2164
16/6	37-2166
16/8	37-2168
16/10	37-2170



STRAIGHT LINE

WIDTH / # OF LINES	HIGH CARBON
16/12	37-2172
16/16	37-2176
18/4	37-2184
18/6	37-2186
18/8	37-2188
18/10	37-2190
18/12	37-2192
20/10	37-2210
24/6	37-2216
24/8	37-2218
26/10	37-2220
28/10	37-2230
30/10	37-2240
32/8	37-2258

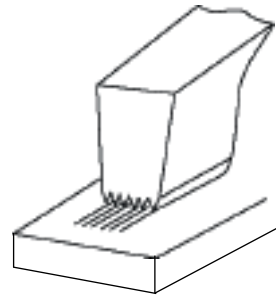

BENT LINE

WIDTH / # OF LINES	HIGH CARBON
6/4	37-2264
6/6	37-2266
6/8	37-2268
6/10	37-2270

3. High Speed Gravers - Yellow Tang

Assured quality Swiss made gravers of High Speed Steel for precision performance. Used by stone setters, die sinkers, jewelers and watchmakers. Excellent for use on all alloys and precious metals. All gravers may be re-sharpened when needed.



ONGLETTE

LO 0403

SIZE	HSS
5/0	37-1346
4/0	37-1347
3/0	37-1348
2/0	37-1349
0	37-1350
1	37-1351
2	37-1352
3	37-1353
4	37-1354
5	37-1355
6	37-1356
7	37-1357
8	37-1358



FLAT

LO 0401

SWISS #	SIZE	HSS
2	36	37-1362
4	37	37-1364
6	38	37-1366
8		37-1368
10	39	37-1370
12	40	37-1372
14	41	37-1374
18	42	37-1376
20	43	37-1378
24	45	37-1380



ROUND

LO 0402

SWISS #	SIZE	HSS
2	50	37-1382
4	51	37-1384
6	52	37-1386
8		37-1388
10	53	37-1390
12	54	37-1392
14	55	37-1394
16		37-1396
18	56	37-1398
20		37-1400



KNIFE

LO 0404

SWISS #	SIZE	HSS
22	1	37-1401
26	2	37-1402
28	3	37-1403

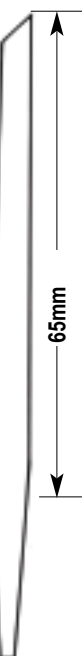

GRAVERS



4. QC - Quick Change Gravers- HSS

Ready to use pre-sharpened, shortened gravers for GRS QC holders and handpieces.



**QC
ONGLETTE
(HSS)**

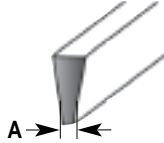

**QC
FLAT
(HSS)**

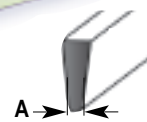

**QC
ROUND
(HSS)**

SIZE	A MM	IKOHE ITEM #	GRS ITEM #
5/0	1.16	37-1416	#022-396
4/0	1.24	37-1417	#022-397
3/0	1.35	37-1418	#022-398
2/0	1.45	37-1419	#022-399
0	1.58	37-1420	#022-400
1	1.78	37-1421	#022-401
2	1.94	37-1422	#022-402
3	2.16	37-1423	#022-403
4	2.54	37-1424	#022-404
5	2.74	37-1425	#022-405
6	2.94	37-1426	#022-406
7	3.14	37-1427	#022-407
8	3.36	37-1428	#022-408

SIZE	A MM	IKOHE ITEM #	GRS ITEM #
36	0.2	37-1436	#022-436
37	0.4	37-1437	#022-437
38	0.6	37-1438	#022-438
39	0.8	37-1439	#022-439
40	1.0	37-1440	#022-440
41	1.2	37-1441	#022-441
42	1.4	37-1442	#022-442
43	1.6	37-1443	#022-443
44	1.8	37-1444	#022-444
45	2.0	37-1445	#022-445
46	2.2	37-1446	#022-446
47	2.4	37-1447	#022-447
48	2.6	37-1448	#022-448
49	2.8	37-1449	#022-449

SIZE	A MM	IKOHE ITEM #	GRS ITEM #
50	0.2	37-1450	#022-450
51	0.4	37-1451	#022-451
52	0.6	37-1452	#022-452
53	0.8	37-1453	#022-453
54	1.0	37-1454	#022-454
55	1.2	37-1455	#022-455
56	1.4	37-1456	#022-456
57	1.6	37-1457	#022-457
58	1.8	37-1458	#022-458
59	2.0	37-1459	#022-459
60	2.2	37-1460	#022-460
61	2.4	37-1461	#022-461
62	2.6	37-1462	#022-462
63	2.8	37-1463	#022-463

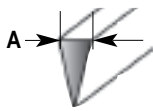

**QC
KNIFE
(HSS)**

SIZE	A MM	IKOHE ITEM #	GRS ITEM #
0	1.8	37-1470	#022-470
1	2.0	37-1471	#022-471
2	2.2	37-1472	#022-472
3	2.4	37-1473	#022-473
4	2.6	37-1474	#022-474
5	2.8	37-1475	#022-475
6	3.0	37-1476	#022-476
7	3.2	37-1477	#022-477

9. GRS® Thermo-Loc® Handles

GRS Thermo-Loc handles are virtually unbreakable. Inside each handle is a formed piece of GRS Thermo-Loc that softens with heat. Insert the tool to the position you need and allow to cool.

The tool is secure and ready to use.

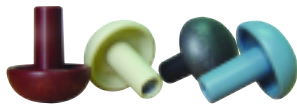

ITEM #	DESCRIPTION
37-2016	#004-800 T/ HANDLE

Set includes: four handles in different colors.

5. STONE SETTER'S QC GRAVER KIT #022-580 37-1680

QC ONGLETTE - 2/0, 0, 1 QC FLAT - 37, 40, 42 QC ROUND - 50, 51, 52, 53 QC KNIFE - K1, K2

6. ENGRAVERS QC GRAVER KIT #022-581 37-1681

QC ONGLETTE - 2/0, 1, 3 QC FLAT - 37, 38, 39, 40, 42 QC ROUND - 51, 52 QC KNIFE - K1, K2

7. STONE SETTER'S MIXED GRAVER KIT #022-525 37-1675

QC ONGLETTE - 2/0, 1 QC FLAT - 40, 42 QC ROUND - 52

GRS CARBIDE - BLANK GLENSTEEL- SQUARE (2) GLENSTEEL- 120°

8. ENGRAVERS MIXED GRAVER KIT #022-526 37-1676

QC ONGLETTE - 2/0, 1 QC FLAT - 37, 38, 39, 40, 42

GRS CARBIDE - BLANK(2) GLENSTEEL- SQUARE GLENSTEEL- 120°

10. GRS® Tungsten Carbide Gravers

TC outlast HSS gravers. They are harder than any tool steel, but more brittle.

Carbide tools need to be sharpened on a diamond lap.



ITEM #	DESCRIPTION
37-1691	#002-233 B1-SQUARE
37-1692	#002-232 B2-BLANK

11. GRS® Heat Treated Steel Points

These hardened steel points let you make custom tools.

They can be made into hammer tools, bead raisers, prong pushers and stipple points. Set of 6 pcs.



ITEM #	DESCRIPTION
37-1693	#002-031 C1-1.8 X 38MM
37-1694	#002-118 C2-3.3 X 76MM
37-1695	#001-624 C3-3.1 X 38MM



GRAVERS

12. NTG - New Traditional Gravers

Standard length gravers with pre-shaped tip. All made of high-speed chrome tool steel.



Factory Shaped Tip...
Saves time and eliminates hand grinding.

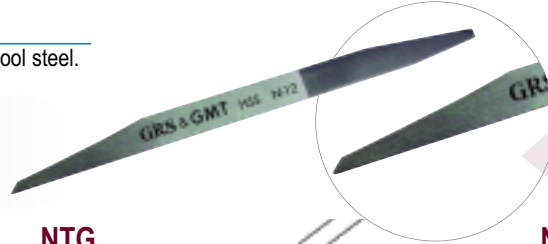

NTG
New
Traditional
Gravers

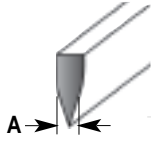

**NTG
ONGLETTE
(HSS)**

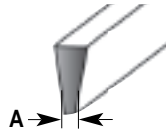

**NTG
FLAT
(HSS)**

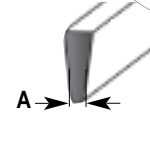

**NTG
ROUND
(HSS)**

SIZE	A MM	IKOHE ITEM #	GRS ITEM #
#5/0	1.16	37-1496	#022-596
#4/0	1.24	37-1497	#022-597
#3/0	1.35	37-1498	#022-598
#2/0	1.45	37-1499	#022-599
#0	1.58	37-1500	#022-600
#1	1.78	37-1501	#022-601
#2	1.94	37-1502	#022-602
#3	2.16	37-1503	#022-603
#4	2.54	37-1504	#022-604
#5	2.74	37-1505	#022-605
#6	2.94	37-1506	#022-606
#7	3.14	37-1507	#022-607
#8	3.36	37-1508	#022-608

SIZE	A MM	IKOHE ITEM #	GRS ITEM #
#36	0.2	37-1536	#022-636
#37	0.4	37-1537	#022-637
#38	0.6	37-1538	#022-638
#39	0.8	37-1539	#022-639
#40	1.0	37-1540	#022-640
#41	1.2	37-1541	#022-641
#42	1.4	37-1542	#022-642
#43	1.6	37-1543	#022-643
#44	1.8	37-1544	#022-644
#45	2.0	37-1545	#022-645
#46	2.2	37-1546	#022-646
#47	2.4	37-1547	#022-647
#48	2.6	37-1548	#022-648
#49	2.8	37-1549	#022-649

SIZE	A MM	IKOHE ITEM #	GRS ITEM #
#50	0.2	37-1550	#022-650
#51	0.4	37-1551	#022-651
#52	0.6	37-1552	#022-652
#53	0.8	37-1553	#022-653
#54	1.0	37-1554	#022-654
#55	1.2	37-1555	#022-655
#56	1.4	37-1556	#022-656
#57	1.6	37-1557	#022-657
#58	1.8	37-1558	#022-658
#59	2.0	37-1559	#022-659
#60	2.2	37-1560	#022-660
#61	2.4	37-1561	#022-661
#62	2.6	37-1562	#022-662
#63	2.8	37-1563	#022-663

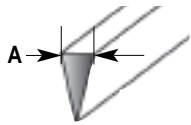

**NTG
KNIFE
(HSS)**

SIZE	A MM	IKOHE ITEM #	GRS ITEM #
K-0	1.8	37-1570	#022-670
K-1	2.0	37-1571	#022-671
K-2	2.2	37-1572	#022-672
K-3	2.4	37-1573	#022-673
K-4	2.6	37-1574	#022-674
K-5	2.8	37-1575	#022-675
K-6	3.0	37-1576	#022-676
K-7	3.2	37-1577	#022-677

QC
Quick
Change
Gravers



Ready-to-Go Gravers!
Fits into any GRS Quick Change holder
and most other power handpieces.

13. STONE SETTER'S NTG GRAVER KIT

#022-582

37-1682

QC ONGLETTE- #2/0, #0, #1

QC FLAT - #37, #40, #42

QC ROUND - #50, #51, #52, #53

QC KNIFE - K-1, K-2

14. ENGRAVERS NTG GRAVER KIT

#022-583

37-1683

QC ONGLETTE- 2/0, 1, 3

QC FLAT - 37, 38, 39, 40, 42

QC ROUND - 51, 52

QC KNIFE - 20, 22

TG
Traditional
Gravers

15. Line Gravers (High Carbon Steel)

For shading, florentine finishing, texturing, etc.

Sizes: First number is the width between lines,
second is the number of lines.

Eg: 18-10 has 10 lines spaced 0.009" apart;
14-6 has 6 lines spaced 0.007" apart.

**LINE GRAVER
STRAIGHT
(HSS)**



SIZE	IKOHE ITEM #	GRS ITEM #
8/6	37-1588	#022-249
14/6	37-1594	#002-693
16/6	37-1596	#002-694
18/10	37-1618	#002-122
20/10	37-1620	#002-695
24/10	37-1624	#011-026



**LINE GRAVER
CURVED
(HSS)**



SIZE	IKOHE ITEM #	GRS ITEM #
14/6	37-1634	#002-035
16/6	37-1636	#002-697
18/10	37-1638	#001-389
20/10	37-1640	#002-698
24/10	37-1644	#002-699

GRAVERS



TG

Traditional Gravers



16. TG - Traditional Gravers

Made of High-Speed Chrome Tool Steel.

ONGLETTE: for line engraving, stone setting, inlay work and borders.

FLAT: for bright cutting, background removal, lettering and borders.

ROUND: for bead raising, block lettering and line engraving.

KNIFE: for fine line engraving, deep narrow cuts and inlay work.

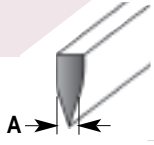
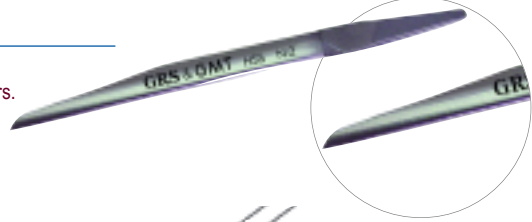

TG ONGLETTE (HSS)

SIZE	A MM	IKOHE ITEM #	GRS ITEM #
#5/0	1.16	37-1696	#022-696
#4/0	1.24	37-1697	#022-697
#3/0	1.35	37-1698	#022-698
#2/0	1.45	37-1699	#022-699
#0	1.58	37-1700	#022-700
#1	1.78	37-1701	#022-701
#2	1.94	37-1702	#022-702
#3	2.16	37-1703	#022-703
#4	2.54	37-1704	#022-704
#5	2.74	37-1705	#022-705
#6	2.94	37-1706	#022-706
#7	3.14	37-1707	#022-707
#8	3.36	37-1708	#022-708

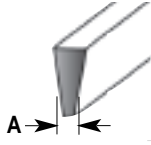

TG FLAT (HSS)

SIZE	A MM	IKOHE ITEM #	GRS ITEM #
#36	0.2	37-1736	#022-736
#37	0.4	37-1737	#022-737
#38	0.6	37-1738	#022-738
#39	0.8	37-1739	#022-739
#40	1.0	37-1740	#022-740
#41	1.2	37-1741	#022-741
#42	1.4	37-1742	#022-742
#43	1.6	37-1743	#022-743
#44	1.8	37-1744	#022-744
#45	2.0	37-1745	#022-745
#46	2.2	37-1746	#022-746
#47	2.4	37-1747	#022-747
#48	2.6	37-1748	#022-748
#49	2.8	37-1749	#022-749

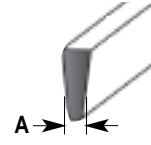

TG ROUND (HSS)

SIZE	A MM	IKOHE ITEM #	GRS ITEM #
#50	0.2	37-1750	#022-750
#51	0.4	37-1751	#022-751
#52	0.6	37-1752	#022-752
#53	0.8	37-1753	#022-753
#54	1.0	37-1754	#022-754
#55	1.2	37-1755	#022-755
#56	1.4	37-1756	#022-756
#57	1.6	37-1757	#022-757
#58	1.8	37-1758	#022-758
#59	2.0	37-1759	#022-759
#60	2.2	37-1760	#022-760
#61	2.4	37-1761	#022-761
#62	2.6	37-1762	#022-762
#63	2.8	37-1763	#022-763

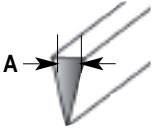

TG KNIFE (HSS)

SIZE	A MM	IKOHE ITEM #	GRS ITEM #
K-0	1.8	37-1770	#022-770
K-1	2.0	37-1771	#022-771
K-2	2.2	37-1772	#022-772
K-3	2.4	37-1773	#022-773
K-4	2.6	37-1774	#022-774
K-5	2.8	37-1775	#022-775
K-6	3.0	37-1776	#022-776
K-7	3.2	37-1777	#022-777

TG Traditional Gravers



BEVEL (HSS)

Knife and Bevel Gravers (High Speed Steel)

Knife gravers for fine line engraving, deep and narrow cuts, inlay work, stone setting. Bevel gravers for bead raising and material removal.

SIZE	IKOHE ITEM #	GRS ITEM #
#1	37-1792	#002-702
#2	37-1793	#002-703



Belt Sander Set-up for Graver Sharpening

Use the belt sander with a diamond micro-finishing belt for sharpening high speed steel and tungsten gravers.

See page # 7

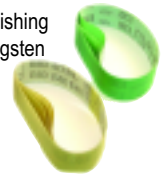

17. GRS® Burnish Tool & Rd. Blank

A special tool made of tungsten carbide, used for burnishing or "Gypsy" stone setting.

The round TC blank is perfect for making texturing tools.



ITEM #	DESCRIPTION
37-1797	#022-347 ROUND 1/8" X 1 1/2"
37-1798	#022-346 B/TOOL 3/32"

18. GRS® Glensteel Gravers

Made of special High Speed Steel (cobalt free). Fits all GRS impact handpieces and QC holders.



ITEM #	DESCRIPTION
37-1781	#002-115 A1 SQUARE
37-1782	#002-116 A2- FLAT
37-1783	#002-120 A3-BLANK

19. GRS Hand Chuck

Two-jaw precision hand chuck is made of hardened and ground steel. Superior V notch grip. Size 2" (51mm) long.



ITEM #	DESCRIPTION
37-2015	#004-000 HAND CHUCK



20. Adjustable Graver Handle Set

These handles let you adjust your graver length for more accurate work.

Set includes three different colored handles made from aircraft aluminum.



Graver not Included

ITEM #	DESCRIPTION
37-2011	#004-670 GRAVER HANDLE

22. Multi-Purpose Tool Holder

Collet chuck holds beading tools, prong pushers and some gravers.



Graver not Included

ITEM #	DESCRIPTION
37-2041	#002-704 TOOL HOLDER

24. Adjustable Graver Handle

Set the gravers to the required length and lock in position with the set screw. Useful for working with gravers of short lengths.



Graver not Included

ITEM #	DESCRIPTION
37-2045	GRAVER HANDLE-2 1/2"
37-2046	GRAVER HANDLE-3"

25. Crocker Pattern-Graver Sharpener

A useful fixture to assist sharpening of gravers on bench stones. Any precise angle may be pre-set with the setting index.



ITEM #	DESCRIPTION
37-2051	GRAVER SHARPENER

26. Graver Sharpeners

A precision tool that secures the gravers in the required angle for sharpening.

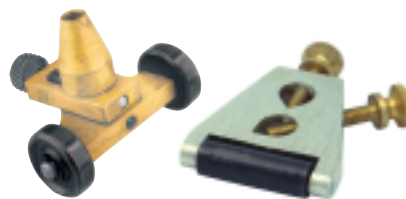

37-2052

37-2053

ITEM #	DESCRIPTION
37-2052	GRAVER SHARPENER
37-2053	GRAVER SHARPENER

27. Holder with Chuck

A hand tool having a hardwood palm grip with a metal screw chuck to secure the shank of millgrain wheels.



23-1261

23-1262

23-1263

ITEM #	DESCRIPTION
23-1261	ROUND
23-1262	MUSHROOM
23-1263	PEAR

21. GRS Tool Organizers

#001-689 Standard Tool Carousel: Organizes and protects 60 gravers and tools in a 5" space on your bench.

#011-193 Combination Tool Carousel: Holds 30 standard tools and gravers in the top tray. The bottom has four removable QC tool trays. Seventy tools may be stored in a small space.

#011-336 QC Tool Trays, Set of 4: Four color-coded trays, each holds ten QC holders.



37-2023

37-2022

ITEM #	DESCRIPTION
37-2021	#001-689 TOOL CAROUSEL
37-2022	#011-193 TOOL CAROUSEL
37-2023	#011-336 TOOL TRAY

23. Graver Handles

Handles for gravers made in fine finished hardwood. Ends are reinforced with metal sleeves to retain the tang firmly in place.



Mushroom

Half Round

Pear

Mushroom

Round

ITEM #	SHAPE	SIZE
37-2031	MUSHROOM	1 1/4" X 2 3/4"
37-2032	MUSHROOM	1 1/4" X 1 3/4"
37-2033	HALF RND	1 1/4" X 2"
37-2034	HALF RND	1 3/8" X 1 5/8"
37-2035	PEAR	1 5/8" X 1 7/8"
37-2036	PEAR	1 1/4" X 1 3/4"
37-2037	ROUND	1 3/8" X 1 5/8"

GRAVERS



28. High Speed Gravers- Red Tang

Made of the finest premium quality High Speed Steel. These gravers will hold an edge up to five times longer than carbon steel. Designed for professional use by jewelers and engravers. High speed steel gravers need to be sharpened on Arkansas stones to achieve a fine cutting edge. May be used by hand or modified for power assisted engraving.



SWISS #	SIZE	HSS
2	36	37-1836
4	37	37-1837
6	38	37-1838
8	39	37-1839
10	40	37-1840
12	41	37-1841
14	42	37-1842
16	43	37-1843
18	44	37-1844
20	45	37-1845
22	46	37-1846
24	47	37-1847
26	48	37-1848
28	49	37-1849



SWISS #	SIZE	HSS
2	50	37-1850
4	51	37-1851
6	52	37-1852
8	53	37-1853
10	54	37-1854
12	55	37-1855
14	56	37-1856
16	57	37-1857
18	58	37-1858
20	59	37-1859
22	60	37-1860
24	61	37-1861
26	62	37-1862
28	63	37-1863



SIZE	HSS
5/0	37-1866
4/0	37-1867
3/0	37-1868
2/0	37-1869
0	37-1870
1	37-1871
2	37-1872
3	37-1873
4	37-1874
5	37-1875
6	37-1876
7	37-1877
8	37-1878



SWISS #	SIZE	HSS
18	0	37-1880
20	1	37-1881
22	2	37-1882
24	3	37-1883
26	4	37-1884
28	5	37-1885
30	6	37-1886
32	7	37-1887



26-3001

Bur Lube Liquid

- Use while sharpening
 - Improves cutting efficiency
 - Extends graver life
- See page # 80

29. High Speed Gravers- Pre-Shaped

A complete collection of pre-shaped gravers made of High Speed Steel. Factory sharpened to regular shapes. Easy to re-sharpen when needed. Hardened to exacting standards to meet the most demanding needs of jewelers and engravers. Use with all power assisted engraving systems.

- FLAT:** for bright cutting, background removal, lettering and borders.
- ROUND:** for bead raising, block lettering and line engraving.
- ONGLETTE:** for line engraving, stone setting, inlay work and borders.
- KNIFE:** for fine line engraving, deep narrow cuts and inlay work.



SWISS #	SIZE	HSS
2	36	37-1936
4	37	37-1937
6	38	37-1938
8	39	37-1939
10	40	37-1940
12	41	37-1941
14	42	37-1942
16	43	37-1943
18	44	37-1944
20	45	37-1945
22	46	37-1946
24	47	37-1947
26	48	37-1948
28	49	37-1949



SWISS #	SIZE	HSS
2	50	37-1950
4	51	37-1951
6	52	37-1952
8	53	37-1953
10	54	37-1954
12	55	37-1955
14	56	37-1956
16	57	37-1957
18	58	37-1958
20	59	37-1959
22	60	37-1960
24	61	37-1961
26	62	37-1962
28	63	37-1963



SIZE	HSS
5/0	37-1966
4/0	37-1967
3/0	37-1968
2/0	37-1969
0	37-1970
1	37-1971
2	37-1972
3	37-1973
4	37-1974
5	37-1975
6	37-1976
7	37-1977
8	37-1978



SWISS #	SIZE	HSS
18	0	37-1980
20	1	37-1981
22	2	37-1982
24	3	37-1983
26	4	37-1984
28	5	37-1985
30	6	37-1986
32	7	37-1987

61-1115
The Art of Engraving
by James B. Meek
Contains step-by-step instructions and technical information with drawings.



HAMMERS



■ Ball Pein Hammers	187	■ Triad Hammer	188
■ Brass Head Mallet	187	■ Watch Maker Hammers	188
■ Chasing Hammers	187		
■ Goldsmith Hammer	188		
■ Mallets-Removable Faces	187		
■ Nylon Mallets-German	188		
■ Oval Head Hammer	185		
■ Peddinghaus Hammers	186		
■ Peddinghaus S/Anvils	184		
■ Picard Hammers	188		
■ Plastic Mallets-USA	188		
■ Rawhide Mallets	187		
■ Riveting Hammers			



Form Emphasis for Metalsmiths

by Heikki Seppa

An advanced manual on the techniques of metalsmithing. Teaches you how to craft metal in terms of pure form. Discusses all the aspects of metal raising, sinking, stretching and fabricating. Includes an illustrated glossary to terms.









61-1076 (Softbound - 146 pages)



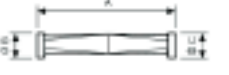

ikohe





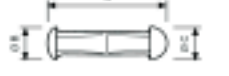

1. Picard Silversmith Hammers

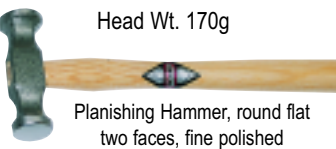
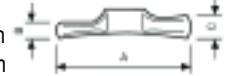
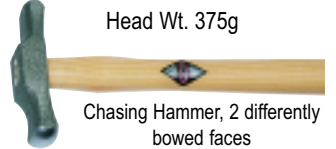
<p>A: 95mm B: 24mm C: 21mm</p>  <p>Head Wt. 200g</p>  <p>Planishing Hammer, 1 flat face, 1 bowed, fine polished</p> <p>38-1011 16501.200</p>	<p>A: 105mm B: 28mm C: 28mm</p>  <p>Head Wt. 375g</p>  <p>Planishing Hammer, 2 flat faces, fine polished</p> <p>38-1012 16601.375</p>	<p>A: 130mm B: 21mm C: 22mm</p>  <p>Head Wt. 200g</p>  <p>Planishing Hammer, 2 flat faces, fine polished</p> <p>38-1013 16701.200</p>	<p>A: 140mm B: 24mm C: 24mm</p>  <p>Head Wt. 300g</p>  <p>Planishing Hammer with 1 flat face, 1 round flat face</p> <p>38-1014 16801.300</p>
--	--	--	---

<p>A: 95mm B: 24mm C: 24mm</p>  <p>Head Wt. 250g</p>  <p>Shrinking Hammer, 2 flat faces, fine polished</p> <p>38-1015 16901.250</p>	<p>A: 95mm B: 24mm C: 24mm</p>  <p>Head Wt. 250g</p>  <p>Polishing Hammer, both sides bowed, fine polished</p> <p>38-1016 17001.250</p>	<p>A: 130mm B: 25mm C: 27mm</p>  <p>Head Wt. 170g</p>  <p>Planishing Hammer, round flat two faces, fine polished</p> <p>38-1017 18601.170</p>	<p>A: 120mm B: 18 X 35mm C: 22 X 35mm</p>  <p>Head Wt. 375g</p>  <p>Chasing Hammer, 2 differently bowed faces</p> <p>38-1018 18701.375</p>
---	--	--	---

PICARD Hammers

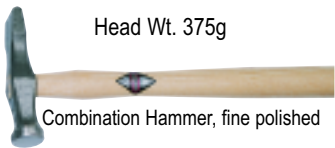
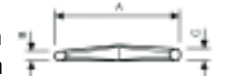
Superior forged steel heads for high performance and durability, all fitted with hickory handles. Specifically designed for all types of planishing, forming, raising and embossing. Widely used by jewelers and metalsmiths. Made in Germany to DIN standards.

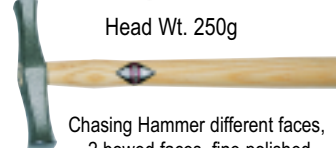
<p>A: 115mm B: 27mm C: 27 X 7mm</p>  <p>Head Wt. 375g</p>  <p>Combination Hammer, fine polished</p> <p>38-1019 18401.375</p>	<p>A: 115mm B: 31 X 10mm C: 33 X 12mm</p>  <p>Head Wt. 250g</p>  <p>Grooving Hammer, different faces, fine polished</p> <p>38-1020 17501.250</p>	<p>A: 125mm B: 20 X 18mm C: 24 X 22mm</p>  <p>Head Wt. 250g</p>  <p>Chasing Hammer different faces, 2 bowed faces, fine polished</p> <p>38-1021 17301.250</p>
--	--	---

Hammer Types

SHRINKING HAMMER : Also known as a dishing hammer. It is used to force metal into a surface that is curved.

PLANISHING HAMMER : Changes the metal surface through hardening. Faces of the hammer must be fine finished or it will leave surface impressions.



POLISHING HAMMER : A well balanced hammer with bowed and mirror finished faces. This feature is advantageous to goldsmiths.



EMBOSSING HAMMER : With repeated hammer strokes the metal is progressively moved from the back to form dimensional shapes.

CHASING HAMMER : Used to create a seamless form through compression with contraction without thinning the metal. Two rectangle faces; each longer than it is wide.

GROOVING HAMMER : Usually has both ends that taper to a vee. Better known as a forging hammer. When hammering it forces metal in opposite directions.

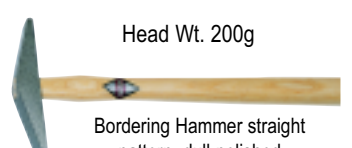
BORDERING HAMMER : Frequently used for working in confined areas, these hammers have narrow horizontal faces.

<p>A: 110mm B: 27 X 7mm C: 27 X 6mm</p>  <p>Head Wt. 250g</p>  <p>Grooving Hammer, different faces, fine polished</p> <p>38-1022 17591.250</p>	<p>A: 115mm B: 20 X 4mm</p>  <p>Head Wt. 200g</p>  <p>Bordering Hammer straight pattern, dull-polished</p> <p>38-1023 17701.200</p>
---	--

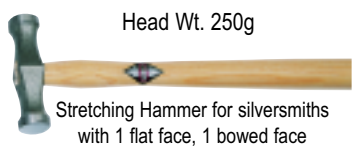
<p>A: 120mm B: 16mm C: 18mm</p>  <p>Head Wt. 175g</p>  <p>Embossing Hammer, 2 high-bowed faces, fine polished</p> <p>38-1024 17401.175</p>	<p>A: 100mm B: 25mm C: 25mm</p>  <p>Head Wt. 250g</p>  <p>Stretching Hammer for silversmiths with 1 flat face, 1 bowed face</p> <p>38-1025 17101.250</p>
---	---



2. Peddinghaus Silversmith Hammers

A: 135mm
B: 23mm
C: 24mm



Head Wt. 300g

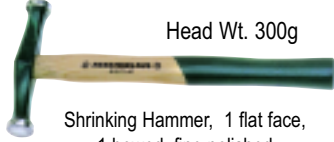

Shrinking Hammer, 1 flat face, 1 bowed, fine polished

38-1041 #50.02

A: 134mm
B: 23mm
C: 22mm



Head Wt. 300g



Shrinking Hammer, 1 flat face, 1 bowed, fine polished

38-1042 #49.02

A: 120mm
B: 30mm
C: 30mm



Head Wt. 500g

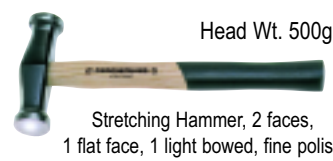

Stretching Hammer, 2 faces, 1 flat face, 1 light bowed, fine polish

38-1043 #60.02

A: 80mm
B: 24mm
C: 24mm



Head Wt. 170g

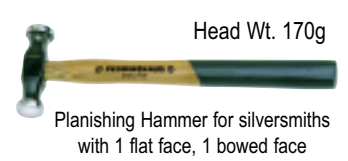

Planishing Hammer for silversmiths with 1 flat face, 1 bowed face

38-1044 #402.02

A: 95mm
B: 23mm
C: 23mm

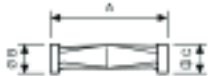

Head Wt. 200g

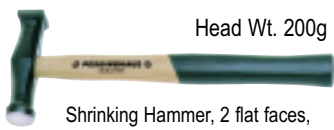

Shrinking Hammer, 2 flat faces, fine polished

38-1045 #47.02

A: 104mm
B: 24mm
C: 24mm



Head Wt. 250g



Polishing Hammer, 1 face light bowed, 1 medium bowed, fine polished

38-1046 #62.02

A: 105mm
B: 14mm
C: 11mm



Head Wt. 100g

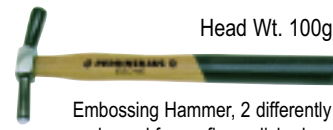

Embossing Hammer, 2 differently bowed faces, fine polished

38-1047 #401.02

A: 135mm
B: 18mm
C: 21mm



Head Wt. 200g

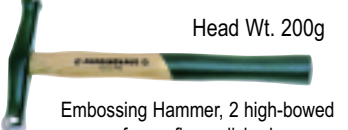

Embossing Hammer, 2 high-bowed faces, fine polished

38-1048 #51.02

A: 120mm
B: 10mm
C: 30mm



Head Wt. 300g



Grooving Hammer, different faces, fine polished

39-1049 #54.02

A: 105mm
B: 27mm
C: 25mm



Head Wt. 300g

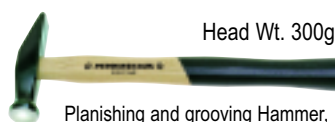

Planishing and grooving Hammer, round face, light bowed

38-1050 #71.02

Peddinghaus Hammers

Made in Germany.

Premium quality German made hammers. Drop forged steel hardened and ground with fine finished faces. All mounted with ash handles shaped for a comfortable grip.

Select from a complete range for:

- Embossing • Planishing • Raising
- Grooving and Forming • Riveting and Tinsmithing



A: 136mm
B: 16mm
C: 20mm

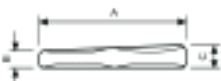

Head Wt. 300g

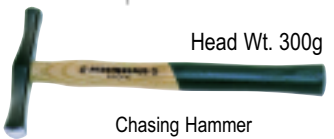

Chasing Hammer 2 flat faces, fine polished

38-1051 #52.02

A: 120mm
B: 12mm
C: 14mm

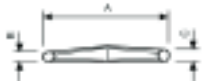

Head Wt. 300g

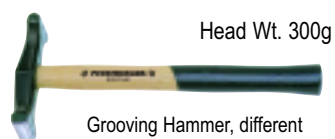

Grooving Hammer, different faces, fine polished

38-1052 #53.02



Silversmithing and Art Metal

by Murray Bovin; Revised by Peter M. Bovin

61-1072 (Softcover – 176 pages)

A: 115mm
B: 20 X 4mm

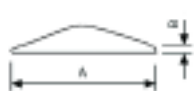

Head Wt. 200g

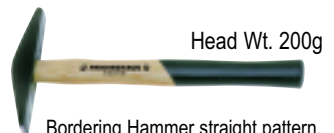

Bordering Hammer straight pattern, dull-polished

38-1053 #57.02

A: 117mm
B: 15mm
C: 20mm



Head Wt. 400g

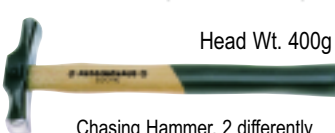

Chasing Hammer, 2 differently bowed faces

38-1054 #403.02

A: 118mm
B: 32mm
C: 32mm



Head Wt. 400g



Double face polishing Hammer, differently bowed, fine polished

38-1055 #63.02

Hammering Surfaces

Silversmiths use a hardened steel surface to shape metal. Swage blocks, anvils and stakes are needed for this operation.





3. Peddinghaus Gold and Silversmithing Anvils

Superior quality forming and raising stakes designed to fit the universal working block.
Anvils and stakes are made in drop forged tool steel, hardened, ground and polished to a mirror finish.
Made in Germany to DIN standards.

Needle Case Anvil - #1-01

Needle case anvil, one flat and one rounded end.
16MM
14MM
600MM



38-1071 WT. 4000g

Needle Case Anvil - #4-01

Needle case anvil, one flat and one round pointed beak.
14MM
10MM
600MM



38-1072 WT. 4000g

Blowhorn Anvil - #10-01

Blowhorn anvil.

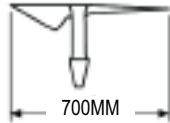

38-1073 7000g

Fretting Anvil - #19-01

Rounded highly polished working surface.
33MM
12MM
325MM



38-1074 6000g

Domed Square Stake

Dome face with four radii corners, dull polished.



38-1081 83-01(1) 2KG

Flat Square Stake

Flat face, two radii and two sharp corners, dull polished.



38-1082 83-01(2) 2KG

High Dome Round Stake

65mm Ø with dull polished high dome.

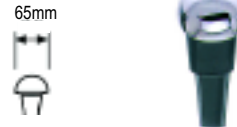

38-1083 83-01(3) 2KG

Flat Round Stake

65mm Ø with dull polished flat round stake.

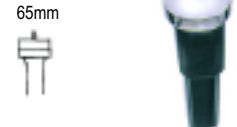

38-1084 83-01(4) 2KG



Universal Working Block

The Peddinghaus forming block is designed with a wide variety of unique shapes. Made of hardened, tempered highly polished tool steel, this solid block accommodates all the different types of stakes and anvils. Dimensions: 4 7/8" X 4 7/8"

38-1080 9.5 KG

Hatchet Stake

Dull polished, straight face, one side rounded face.

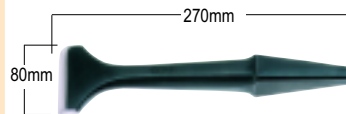

38-1091 35.01 1KG

Mushroom Stake-Low Dome

Socket, round face, bowed to the middle, working surface fine polished.

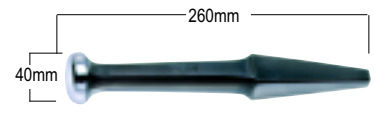

38-1092 41.01 1KG

Mushroom Stake-High Dome

Socket, face high bowed, working face fine polished.



38-1093 42.01 1KG

Flat Round Stake

Socket, flat face, working face fine polished.



38-1094 39.01 1KG

Dome Round Stake

Socket, face flat bowed, working face fine polished.

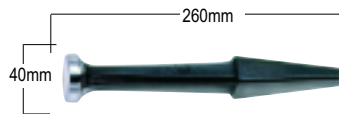

38-1095 40.01 1KG

Flat Square Stake

Socket, flat face, working face fine polished.

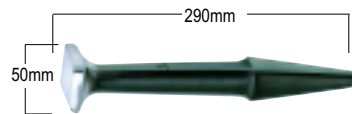

39-1096 43.01 1.6KG



HAMMERS

4. Goldsmith Hammers

Especially designed for the jeweler, this hammer is made of gun metal with polished finished ends. One end is flat and the other is chisel shaped. Ideal for riveting, forming and shaping work.



ITEM #	DESCRIPTION
38-1161	GOLDSMITH HAMMER- GERMANY
38-1061	GOLDSMITH HAMMER- VALUE

5. Ball Pein Hammers

Made of drop forged polished hardened steel with a hardwood handle for solid striking force. One end flat and the other round.



ITEM #	NET WT.
38-1066	1 OZ. (30g)
38-1067	2 OZ. (60g)
38-1068	4 OZ. (110g)
38-1069	8 OZ. (200g)

6. Chasing Hammers

Made of forged steel with a hardwood handle. One large face to flatten and the other round to form shapes.



ITEM #	DESCRIPTION	DIA.
38-1121	4 OZ. -GERMAN	1"
38-1122	5 OZ. -GERMAN	1 1/8"
38-1126	6 OZ. -VALUE	1 1/4"
38-1127	4 OZ. -VALUE	1 1/8"

You need to know....

that when you work metal it gets harder and more brittle. Annealing the metal in between hammering will keep the metal flexible and workable.

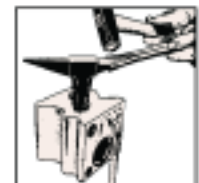

7. Brass Head Mallets

Solid brass head will not mar thin or soft metals. Fitted with a hardwood handle, overall length 9".



ITEM #	DESCRIPTION	NET WT.
38-1301	BRASS & NYLON HEAD	2 OZ.
38-1302	BRASS HEAD	2 OZ.

8. Nylon Mallets-Germany

These soft nylon faced mallets will not mar or dent work. Mallet is well balanced and comes with a hardwood handle.



ITEM #	DESCRIPTION
38-1306	NYLON Mallet - 22 MM
38-1307	NYLON Mallet - 27 MM

9. Riveting Hammers

Made of drop forged chrome plated steel with hardwood handles. Head has one flat side for spreading and the other tapered for levelling.



ITEM #	DIA.	HEAD
38-1165	3/8" X 3"	ROUND-FRANCE
38-1166	1/2" X 3 5/8"	ROUND-FRANCE
38-1167	1/2" X 4"	SQUARE-GERMANY
38-1064	1/2" X 3 5/8"	SQUARE-VALUE

HAMMERS



10. Rawhide Mallets- USA

Made of tough, long wearing, cured rawhide. Ideal for use on broad faced striking surfaces. All fitted with durable hardwood handles.



ITEM #	#	HEAD (Ø X L)	WT.
38-1311	0	1" X 2"	2.5 OZ.
38-1312	1	1¼" X 2½"	4.5 OZ.
38-1313	2	1½" X 3"	6.0 OZ.
38-1314	3	1¾" X 3½"	9.5 OZ.
38-1315	4	2" X 3½"	12 OZ.

11. Mallets-Changeable Faces

The ends of this mallet face may be changed to any combination. Different ends of fiber, nylon or brass are available.



ITEM #	DESCRIPTION
38-1321	BRASS & FIBER 4 OZ.
38-1322	BRASS & NYLON 4 OZ.
38-1323	REPLACEMENT -BRASS HEAD
38-1324	REPLACEMENT -FIBER HEAD
38-1325	REPLACEMENT -NYLON HEAD

12. Oval Head Hammer

The best tool for jewelers. This hammer has interchangeable heads of brass, nylon and steel. Ergonomic handle for a comfortable grip.



ITEM #	DESCRIPTION
38-1351	HAMMER WITH 3 HEADS
38-1352	REPLACEMENT -BRASS HEAD
38-1353	REPLACEMENT -NYLON HEAD
38-1354	REPLACEMENT -STEEL HEAD

13. Plastic Mallets -USA

Abrasion resistant plastic mallet fitted with a hardwood handle that has a bounce similar to rawhide. Will not mar or spark, also easy to clean.



ITEM #	#	HEAD (Ø X L)	WT.
38-1331*	1	1¼" X 3"	4 OZ.
38-1332	2	1½" X 4"	6 OZ.
38-1333	3	1¾" X 5"	9 OZ.
BALL PEIN PLASTIC MALLET			
38-1339		3 X 1¾"	9 OZ.

* Picture not shown

14. Watchmaker Hammers

Swiss style hammers, with finely polished forged steel heads fitted on hardwood handles. Use for miniature work.



ITEM #	DESCRIPTION	H.L. *
38-1341	W/MAKER HAMMER	50MM
38-1342	W/MAKER HAMMER	60MM
38-1343	W/MAKER HAMMER	70MM
38-1344	W/MAKER HAMMER	80MM
38-1345	W/MAKER HAMMER	90MM

* H.L- Head Length

15. Triad Hammer

A versatile well finished hammer that combines three different hammer heads in one tool. The head is a single unit with brass, nylon and steel faces. To change faces, pull and turn.



ITEM #	DESCRIPTION
38-1357	TRIAD HAMMER
23-1011	2" ANVIL



LAMPS & LOUPES

■ Asymmetric Fluorescent Lamp	191
■ B & L® Coddington Loupes	193
■ B & L® Folding Pocket Magnifier	192
■ B & L® Hasting Triplet M/Magnifier	192
■ B & L® Hasting Triplet Loupes	193
■ B & L® Illuminated Coddington Loupe	193
■ B & L® Illuminated Stand Magnifier	193
■ B & L® Magna Visor	196
■ B & L® Measuring Scales	192
■ B & L® Spectacle Loupes	198
■ Chelsea Emerald Filter	192
■ Clips-on Opticaid® Magnifier	198
■ Dazor® Bench Flex	190
■ Dazor® Circline Magnifying Lamps	190
■ Dazor® Lamps	194
■ Double Lens 10X Loupes	195
■ Eschenbach Precision Loupes	191
■ Fluorescent Lamps	194
■ Gems 10X Triplet Loupes	193
■ Gold Loupes-14 kt	195
■ H. Schneider® Jewelers Loupe	194
■ IKOHE 10X Triplet Loupes	195
■ IKOHE Jewelers Loupes	193
■ Jade & Ruby Filters	193
■ Loupe Chains	193
■ Magna Deluxe Fluorescent Lamp	191

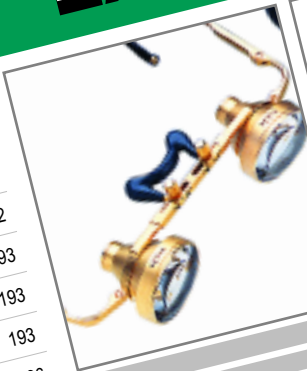

■ Magnifying-Eye Glasses	196
■ Megaview - Japan	196
■ Mighty Mag Illuminated Magnifier	191
■ Nikon Professional Loupe	195
■ OptiSIGHT™ -USA	197
■ OptiVISOR® LX	197
■ OptiVISOR®- USA	192
■ Portable Flip Lamp- White Light	193
■ Sight Savers	198
■ Spring Clip Opticaid® Magnifier	198
■ Telesight Magnifier	192
■ UV Portable Lights	195
■ Zeiss® Loupes	195

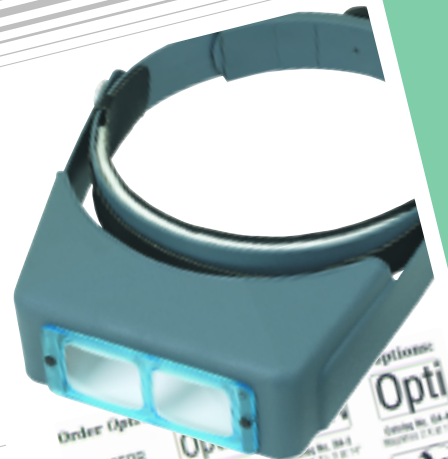

Gemstones of the World

by **Walter Schumann**
 A comprehensive reference guide for gemstones containing color photos of more than 1,400 specimens. Includes technical data on gemstone properties, formation and structure of gems and cutting. Recommended for beginners and experts.
61-1235 (Hardcover – 272 pages)





1. Dazor® Fluorescent Lamps

Used by professionals in the fields of inspection, quality control, manufacturing and repair. Metal construction in baked enamel finish. Feather touch arm moves easily and stays in position. The clamp type may be mounted in vertical or horizontal position. Comes complete with (15W each) bulb, cord and power plug. Available colors gray or black in either desk or clamp fitting. Unit is backed by a warranty. Bulbs are not covered by warranty. UL approved.



Clamp-on magnifier See pg#192

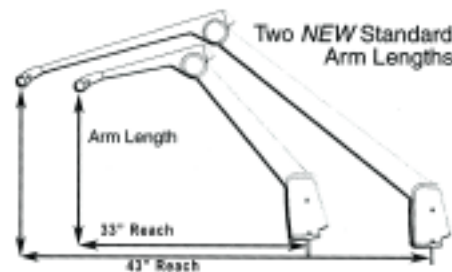

TYPE	STYLE	REACH	GRAY	BLACK	VOLTS
CLAMP	2-TUBE	43"	39-1011	39-1021	110V
CLAMP	2-TUBE	43"	39-1012	39-1022	220V
DESK	2-TUBE	33"	39-1013	39-1023	110V
DESK	2-TUBE	33"	39-1014	39-1024	220V
CLAMP	3-TUBE	43"	39-1015	39-1025	110V
CLAMP	3-TUBE	43"	39-1016	39-1026	220V
DESK	3-TUBE	33"	39-1017	39-1027	110V
DESK	3-TUBE	33"	39-1018	39-1028	220V

39-1020 15W REPLACEMENT DAYLIGHT BULB



2. Dazor® Circline Magnifying Lamps

Dazor's #1 seller, designed for inspection, assembly and precision work. This popular 5" Ø magnifier is a 3-diopter (+75%) made in Crown optical glass. The patented floating arm is a well balanced mechanism totally enclosed for elegance and safety. UL approved. Includes 22W Circline cool white fluorescent tube.

TYPE	REACH	GRAY	BLACK	VOLTS
CLAMP	42"	39-1031	39-1041	110V
CLAMP	42"	39-1032	39-1042	220V
DESK	28"	39-1035	39-1045	110V
DESK	28"	39-1036	39-1046	220V

39-1040 22W REPLACEMENT COOL WHITE BULB

3. Dazor® Bench-Flex

Dazor's #1 bench mounted lamp meets the unique lighting demands of the professional jeweler. Rugged all metal construction and powder coated for long lasting use. It can be moved into any angle for shadow-free or hi-light viewing. The Bench-Flex has a 22" arm and comes with two 15-watt daylight tubes (6500° K). Clamp bushing is for use on jewelers bench in right or left positions.

Bench-Flex includes all metal dual clamp and bushing mount.

TYPE	REACH	GRAY	BLACK	VOLTS
DUAL CLAMP	22"	39-1051	39-1061	110V
DUAL CLAMP	22"	39-1052	39-1062	220V
39-1065	REPLACEMENT BUSHING			
39-1066	LAMP SHIELD FOR BENCH FLEX			
39-1020	15W REPLACEMENT DAYLIGHT BULB			





4. Dazor LED Diamond Lights

This truly revolutionary product provides a light source of superior quality. Unique models feature the DAZOR "floating arm" that is easily positioned with the touch of a finger. Rugged construction has no exposed springs or wires. Stands up to intensive everyday use by professionals.

Features:

- Advanced illumination technology
- Delivers 5x the lumen density of a standard 5mm LED
- Color corrected light provides high quality light (5800-6500K°)
- Increased power with a 6-LED light source UV free
- Dimmable down to 30% of full light output
- Optics built into the LED's means no need to add or remove diffusers



ITEM #	DESCRIPTION
39-1071	LED DIA. LIGHT CLAMP BASE 24" 110/220V -BLACK
39-1073	LED DIA. LIGHT CLAMP BASE 34" 110/220V -BLACK
39-1075	LED DIA. LIGHT DESK BASE 24" 110/220V - BLACK
39-1077	LED DIA. LIGHT FLEX ARM 22" 110/220V - BLACK

- Also available in white

5. Mighty Mag Illuminated Magnifier

Ideal for fine detail work. Large 6" x 7" crystal-clear lens for distortion-free viewing.

Features:

- Includes twin side mounted 9 Watt tubes
- Mar resistant housing in Ivory color
- Spring balanced arm with a 35" reach
- Comes with 5 ft. power cord

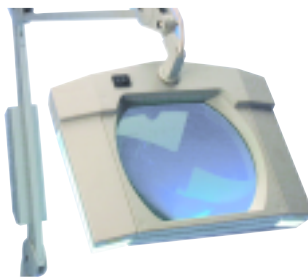

ITEM #	DESCRIPTION
39-1081	MAGNIFIER 110V - 9 W 2 TUBES
39-1083	REPLACEMENT BULB 9W

7. Magna Deluxe Fluorescent Lamp

The Magna Deluxe lamp provides uniform light over maximum area. A built-in electronic ballast increases lumens. The unit is designed with a heavy-duty arm, concealed steel springs and smooth-glide tension control knobs.

Features:

- A 55W fluorescent bulb enclosed in a 20" head
- The head swivels 310° and tilts 210° for maximum flexibility.
- Comes with a separate table top base
- Includes 5' of power cord and clamp
- UL approved.



ITEM #	DESCRIPTION
39-1087	DELUXE LAMP- 110V / 60 HZ
39-1088	DELUXE LAMP- 220V / 50 HZ
39-1089	REPLACEMENT BULB -55W

6. Fluorescent Lamp

A natural daylight lighting system that provides shadow free illumination. Useful for inspection, soldering and assembly work.

Features:

- 19" Rectangular head
- Includes two 15 watt fluorescent bulbs
- Spring balanced arm with a 45" reach
- Comes with 5 ft. power cord



ITEM #	DESCRIPTION
39-1084	FLUORESCENT LAMP110V/15W
39-1086	REPLACEMENT BULB- 15W

8. Asymmetric Fluorescent Lamp

Energy saving lamp provides a soft diffused light for comfortable viewing. The asymmetric pattern of the light lowers the reflective glare over the work area.

Features:

- Comes with a separate table top base
- Adjustable arm with clamp on base
- Includes 13W bulb, cord and plug



ITEM #	DESCRIPTION
39-1091	FLUORESCENT 110V / 13 W
39-1092	FLUORESCENT 220V / 13 W
39-1093	REPLACEMENT BULB - 13 W



9. Portable Flip Lamp- White Light

Especially for gems and jewelry, these lightweight, compact folding lamps are excellent for stone grading and color matching.

Features:

- Adjustable positioning and an auto shut off when closed
- May be swiveled a full 360°
- A 13 W fluorescent bulb is included



ITEM #	DESCRIPTION
39-1201	FLIP LAMP 110V / - 13 W
39-1202	FLIP LAMP 220V / - 13 W
39-1203	REPLACEMENT BULB - 13 W

10. UV Portable Lights

Key Chain Light: Produces a bright UV source of light to check fluorescence.

Ultra Violet Light: UV light ideal for quick examination of fluorescence in diamonds and gem stones. Comes with batteries and case. Overall 4½" long.



ITEM #	DESCRIPTION
39-1211	U/VIOLET KEY CHAIN LIGHT-1 LED
39-1212	ULTRA VIOLET LIGHT -3 LED

11. Clamp-on Magnifier

Convenient clip on magnifier for hands-free working. Fit to any lamp. Ideal for sorting, inspection and detail work. Flips up when not required.

ITEM #	DESCRIPTION
39-1009	CLAMP-ON MAGNIFIER- 5X



12. Chelsea Emerald Filter

Identify emeralds professionally. The filter detects dyed green and blue chalcedony when viewed in intense light. Synthetic emeralds will appear red or pink, while green stones will appear green.



ITEM #	DESCRIPTION
39-1431	EMERALD FILTER

13. B & L® Folding Pocket Magnifier

Made of optical glass and mounted in a protective swing away case. These are available in a wide range of power from 3X to 20X by a combination of 2 or 3 lenses.

- 39-1251- comes with 2 lenses
- 39-1252- comes with 3 lenses



ITEM #	POWER	LENS Ø	F/DIST.
39-1251	3X, 4X- (7X)	37.0	3.3"-1.4"
39-1252	3X, 7X, 9X - (20X)	20.3	2"-5"



14. B & L® Hasting Triplet Measuring Magnifier

A high end magnifier for precision work. The lens is adjustable for individual focus and provides a flat distortion free image. Available in 7X or 10X magnification. **Measuring scales are sold separately.**



ITEM #	POWER	LENS Ø	F/DIST.
39-1261	7X- MAGNIFIER	19.80	1.5"
39-1262	7X LENS	19.80	1.5"
39-1263	10X- MAGNIFIER	15.80	1.0"
39-1264	10X LENS	15.80	1.0"

B & L® Measuring Scales (Sold Separately)

General Purpose Scale:
Measures radii 1/16" - 3/8"

Inch Scale:
Measures 3/4" 0.005 interval

Metric Scale:
Measures 2mm in 0.1 interval

Protractor Scale:
Measures 360° in single degrees.

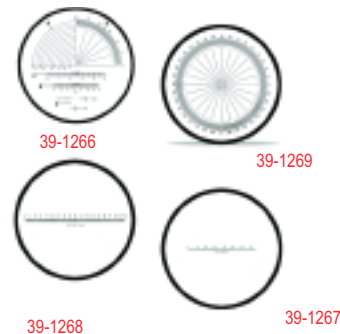

ITEM #	DESCRIPTION
39-1266	GENERAL PURPOSE
39-1267	INCH SCALES
39-1268	MM SCALES
39-1269	PROTRACTOR SCALE



LAMPS & LOUPES

15. B & L® Illuminated Stand Magnifier

Free standing magnifier offers versatility for laboratories, hobby and craft work. Lens power and light intensity is adjustable. Lens can be tilted and hand held objects can be conveniently inspected.



ITEM #	POWER	LENS SIZE	INSET LENS
39-1294	2X	2" X 4"	19.75MM

16. B & L® Illuminated Coddington Loupe

A combined magnifier and light source. Illuminates the object being viewed through the lens. Powered by two AA penlight batteries (not included). Measures 5 3/4" overall length.



ITEM #	POWER	F/DIST.	LENS Ø
39-1291	10X	1"	19.75MM

17. B & L® Coddington Loupes

Single lens constructed loupe with an internal diaphragm to provide a larger field of distortion free viewing. Chrome plated swing type case protects the loupe.



ITEM #	POWER	F/DIST.	LENS Ø
39-1276	10X	1"	19.75MM
39-1277	14X	3/4"	15.75MM
39-1278	20X	1/2"	12.45MM

18. B & L® Hasting Triplet Loupes

A Hastings lens has three lenses bonded together to form a compound lens. View sharp magnified images with no color distortion.



ITEM #	POWER	F/DIST.	LENS Ø
39-1271	7X	1 1/2"	19.8MM
39-1272	10X	1"	15.8MM
39-1273	14X	3/4"	12.5MM
39-1274	20X	1/2"	8.25MM

19. B & L® Sight Savers

Pre-moistened lens cleaning tissue, individually packed and conveniently boxed. Quick and safe cleaning of acrylic or glass lenses to improve clarity.



- Each dispenser has 100pcs. 2" x 2" packet.
- Individually wrapped tissue folds out to 5" x 8"

ITEM #	DESCRIPTION
39-1290	SIGHT SAVER

20. Gold Loupes-14 kt

An exquisite gift for jewelers who need nothing but the best. Clear color corrected lens with 10x, 14x or 20x magnification, set in a finely crafted 14 kt gold basket weave case.



ITEM #	POWER	F/DIST.	GOLD
39-1421	10X	1"	21G
39-1422	14X	3/4"	19G
39-1423	20X	1/2"	16G

21. Loupe Chains

Fit this chain to the swivel end of your jeweler's loupe to keep it handy at all times.



ITEM #	DESCRIPTION
39-1398	GOLD PLATED
39-1399	CHROME PLATED

22. Jade & Ruby Filters

Helps you differentiate between imitations and simulant, when viewed under intense light.



ITEM #	DESCRIPTION
39-1432	JADE FILTER
39-1433	RUBY FILTER

For watchmaker's loupes see page # 321



GEMS 23. Gems 10X Triplet Loupes-Hex

Four models are available. Each has a large, clear, tintless round glass lens. Working distance 1". Comes with leather pouch.

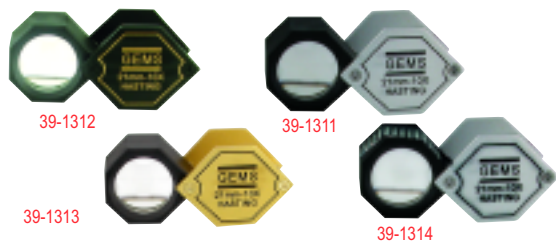

ITEM #	TYPE	LENS Ø
39-1311	BLACK	21MM
39-1312	CHROME	21MM
39-1313	GOLD	21MM
39-1314	RUBBER	21MM

ikohe 24. 10X Triplet Loupes-Hex

Color corrected triplet lens that ensures distortion free viewing.



ITEM #	TYPE	LENS Ø
39-1316	BLACK	20.5MM
39-1317	CHROME	20.5MM
39-1318	GOLD	20.5MM
39-1319	RUBBER	20.5MM

25. Double Lens 10X Loupes

An economical combination of two lenses that provide distortion free viewing.



ITEM #	POWER	LENS Ø
39-1341	10X	14MM
39-1342	10X	23MM

26. Eschenbach Diamond Tester

Lens: Biconvex, optically ground silicate glass
Body: Brass, chrome-plated, matte finish
Case: Leather cases available

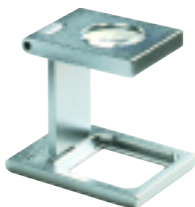

ITEM #	DESCRIPTION
39-1346	LINEN TESTER 10X

GEMS 27. Gems 10X Triplet Loupes

Four models are available. Each has a large, clear, tintless round glass lens. Working distance 1". Comes with leather pouch.



ITEM #	TYPE	LENS Ø
39-1321	BLACK	18MM
39-1322	CHROME	18MM
39-1323	GOLD	18MM
39-1324	RUBBER	18MM

ikohe 28. 10X Triplet Loupes

Color corrected triplet lens that ensures distortion free viewing.



ITEM #	TYPE	LENS Ø
39-1325	BLACK-10X	18MM
39-1326	CHROME-10X	18MM
39-1327	GOLD-10X	18MM
39-1328	RUBBER-10X	18MM
CHROME- 20 X		
39-1329	CHROME- 20X	18MM

29. Eschenbach Maxdetail Glasses

Hands-free, head-mounted glasses provide 2x magnification and can be adjusted so that each eye lens can be focused separately ± 3 diopters. The glasses will focus on near objects with working distances of 16" and are perfect for any near viewing activity where a magnified image is helpful.



ITEM #	POWER	WORK. DIST.
39-1348	2X	16"



30. Eschenbach Precision Loupes & Binoculars

- A folding magnifier made of fiberglass and reinforced polyamide
- Sealed construction protects loupe from dust particles
- Aplanatic lens provides a distortion free image
- Color corrected lens to eliminate optical distortion

ITEM #	POWER		LENS Ø
39-1351	3X+6X	ACHROMATIC	23MM
39-1352	10X	APLANATIC	23MM



Eschenbach Binoculars

- Unique adjustable frame allows the system to be fitted immediately so it can be used THAT DAY! No lab required!
- Adjustable bars for the papillary distance can be locked in place simply by tightening the screws and using the included lockwasher
- Frame features cold bend wire-core temples (150 mm in length) and an adjustable saddle bridge

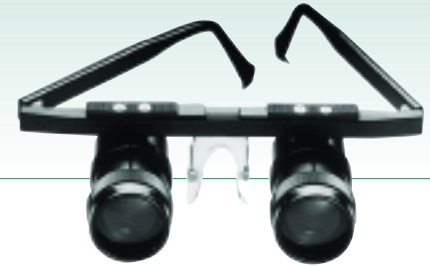

Achromatic: A lens which corrects for achromatic aberration, transmits light that forms images practically free from prismatic colors. **Aplanatic:** A lens which corrects for spherical aberration & coma. **Coma:** A blurred appearance or hazy border surrounding an object viewed through a lens. **Coddington:** A corrected lens named after a British inventor. **Magnifier:** A lens that increases the apparent size of objects seen through it. It may be a single lens or a compound lens. **Field of View:** The higher the power the smaller the field of view. **Focal Length:** The distance at which a magnifier must be held away from an object to achieve clear focus. **Power:** This refers to the capacity in the lens to increase the image size, thus a 2X magnifier creates an image twice as large as that which the unaided eye sees at 10 inches.

ITEM #	POWER		LENS Ø
39-1354	2.5X	BINOCULARS	23MM
39-1355	4X	BINOCULARS	23MM

31. Zeiss Professional Loupe

Pocket Magnifier for the professional. The aplanatic and achromatic design of the Zeiss lens system provides a field of view that is free of chromatic aberrations and distortion in the peripheral zone. The anti-reflective coating prevents glare. Comes in a leather pouch.



ITEM #	POWER	F/DIST.	LENS Ø
39-1356	6X	1"	22MM
39-1357 *	3X + 6X	1"	22MM
39-1358	10X	1"	19.75MM

* picture not shown

32. Ikohe Jeweler's Loupe

This 10X jeweler's loupe is manufactured from quality optical glass and tested to exacting standards. The loupe gives edge to edge brightness and sharpness and features a fully color corrected triplet lens.



ITEM #	POWER	FOCAL	LENS Ø
39-1368	10X	1"	21MM

33. Nikon Professional Loupe

A rare combination of peerless clarity and unrivaled optical quality from the world leader in optics. Compound lenses deliver a distinct magnified image with no color distortion. Images are as sharp at the edges as at the center. Comes in a leather pouch.



ITEM #	POWER	F/DIST.	LENS Ø
39-1361	10X	1"	19.75MM

34. H. Schneider® Professional Loupes

39-1366: A world renowned professional jeweler's loupe. Unsurpassed high quality viewing through a three lens system. The aplanatic-achromatic design provides a view that is distortion free from every angle.



39-1367: GemologyPro is the latest loupe from H. Schneider, 10X, 20MM dia. the advance optics provide sharp, crisp and clean images for the discerning jeweler.



ITEM #	POWER	F/DIST.	LENS Ø
39-1366	10X	1"	21MM
39-1367	10X	1"	21MM



39-1451

LENS



39-1461



39-1464

39-1465

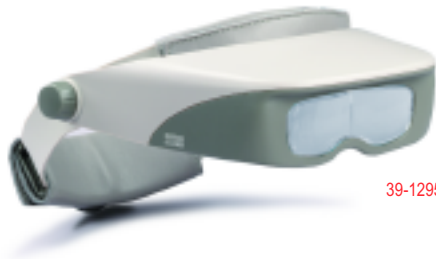

39-1295



39-1412

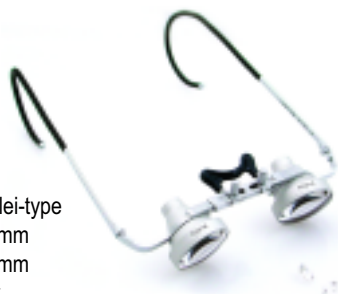

39-1411

Specifications:

Style of construction: Galilei-type
 Working Distance: 250mm
 With front lens attachment: 370mm
 Magnification: 2.3x
 Range of vision: 50mm

35. Megaview Plastic Lenses- Japan

Ideal for viewing micro-fine details without distortion. Light in weight, high quality lenses have a scratch proof coating. Supplied with three lenses (2x, 2.5x and 3x).

ITEM #	DESCRIPTION
39-1451	MEGAVIEW- 3 LENSES (2X, 2.5X & 3X)
39-1452	LENS -1.7X
39-1453	LENS -2X
39-1454	LENS -2½X
39-1455	LENS -3X
39-1456	LENS -4X

36. Megaview Compact MG-3- Japan

Light and compact magnifier offers complete versatility. Easy to change lenses. Lens tilts up and out of way when magnified viewing is not necessary. Supplied with three lenses (2x, 2.5x and 3x).

ITEM #	DESCRIPTION
39-1461	COMPACT MG-3 WITH 3 LENSES (2X, 2.5X & 3X)

37. Megaview Pro with LED- Japan

This head band magnifier is ideal for increased clarity and comfort. Supplied with three lenses (2x, 2.5x and 3x).

ITEM #	DESCRIPTION
39-1464	PRO LED WITH 3 LENSES & SINGLE EYE LENS(4X)
39-1465	SINGLE EYE LENS ONLY -4X

38. B & L® Magna Visor- USA

A quality visor for hand free viewing. Lightweight acrylic lenses give you the precision for detail work, crafts and hobbies. The molded frame is padded with a removable, washable fabric. Can be worn over prescription lenses. Includes three lenses with different focal lengths.

ITEM #	DESCRIPTION
39-1295	MAGNA VISOR WITH 6", 8", 12" LENSES
39-1296	LENS -6"
39-1297	LENS -8"
39-1298	LENS -12"

39. Magnifying-Eye Glasses- German

High quality binocular magnifying glasses ensure a stereoscopic view. Using two front lenses the working distance can be increased up to 370mm. You can focus the individual distance between the eyes by axial moving of the magnifying system. Extremely comfortable for working over extended periods of time.

ITEM #	DESCRIPTION
39-1411	MAGNIFYING GLASS (2.3X) - CHROME
39-1412	MAGNIFYING GLASS (2.3X) - GOLD
39-1413	FRONT LENS ATTACHMENT



40. OptiVISOR® -USA

OptiVISOR lenses are manufactured from high quality optical glass prepared to ophthalmic standards. Frames are light in weight, durable and impact resistant. The visor is pivot mounted to the head band so that it may be adjusted to any position. Lens plates are interchangeable.

Optical Glass Lens

ITEM #	STYLE	POWER	FOCAL
39-1501	DA2	1½X	20"
39-1502	DA3	1¾X	14"
39-1503	DA4	2X	10"
39-1504	DA5	2½X	8"
39-1505	DA7	2¾X	6"
39-1506	DA10	3½X	4"

Lens Plates- LP

ITEM #	STYLE	POWER	FOCAL
39-1511	#2	1½X	20"
39-1512	#3	1¾X	14"
39-1513	#4	2X	10"
39-1514	#5	2½X	8"
39-1515	#7	2¾X	6"
39-1516	#10	3½X	4"

OptiVISOR®



39-2261



39-2263

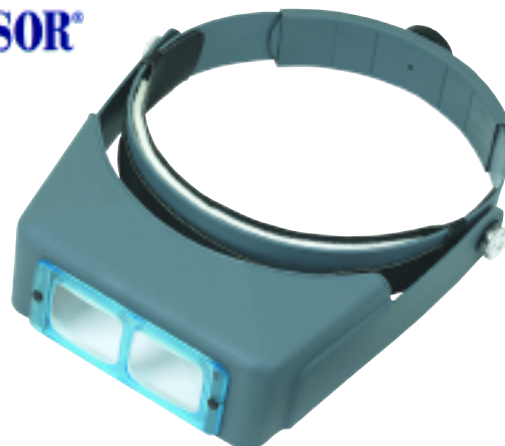

Accessories:

ITEM #	DESCRIPTION
39-2261	OPTILOUPE ATTACHMENT 2½X
39-2262	COMFORT LEATHER BAND
39-2263	V/LIGHT W/BATT. PACK-4' CORD
39-2264	V/LIGHT REPLACEMENT BULB

41. OptiVISOR® LX

Long lasting lightweight lenses made from scratch resistant materials. Fitted with optical prismatic lenses. The LX has adjustable side pivots that allow the visor to be tilted to the correct viewing angle. It also includes an adjustable felt padded headband to comfortably fit all head sizes.



Optical Acrylic Lens

Lens Plates

ITEM #	STYLE	POWER	FOCAL
39-1531	LX3	1¾X	14"
39-1532	LX4	2X	10"
39-1533	LX5	2½X	8"
39-1534	LX7	2¾X	6"

ITEM #	STYLE	POWER	FOCAL
39-1541	LX3	1¾X	14"
39-1542	LX4	2X	10"
39-1543	LX5	2½X	8"
39-1544	LX7	2¾X	6"

Accessories

39-1548	ACCURLOUPE -2½X
---------	-----------------



39-1548

42. OptiSIGHT™ -USA

OptiSIGHT optical grade acrylic magnifying visor. Provides hands-free magnification for more accurate viewing. The visor tilts up for normal viewing or down for magnification. OptiSIGHT brings work closer into focus, reducing eye strain and fatigue. Includes three interchangeable lenses (#3, #4 & #5) Available in assorted colors.

ITEM #	DESCRIPTION
39-1551	W/3 LENS PLATE -GREEN
39-1552	W/3 LENS PLATE-BLUE
39-1553	W/3 LENS PLATE-TAN
39-1554	W/3 LENS PLATE-RED
39-1555	W/3 LENS PLATE-PURPLE
39-1556	W/3 LENS PLATE-GRAY

Lens Plates

ITEM #	DESCRIPTION	POWER
39-1561	LENS PLATE #3	1¾X
39-1562	LENS PLATE-#4	2X
39-1563	LENS PLATE-#5	2½X
39-1564	LENS PLATE-#7	2¾X





43. Telesight Magnifier-Full Frame and Half-Frame

Binocular eye loupe in full-frame, half-frame and clip-on type. May be used with prescription glasses including bifocals. Lenses are of optical quality acrylic and are abrasion resistant. Light in weight with tension clamps for instant attachment and flip-up.



ITEM #	STYLE	POWER	F/DIST
39-1601	33	1 $\frac{3}{4}$ X	14"
39-1602	34	2X	11"
39-1603	35	2 $\frac{1}{4}$ X	9"
39-1604	36	2 $\frac{1}{2}$ X	7"
39-1605	38	3X	5"

Telesight Magnifier-Half Frame

39-1611	43	1 $\frac{3}{4}$ X	14"
39-1612	44	2X	11"
39-1613	45	2 $\frac{1}{4}$ X	9"
39-1614	46	2 $\frac{1}{2}$ X	7"
39-1615	48	3X	5"

Telesight Magnifier-Clip-On

39-1621	23	1 $\frac{3}{4}$ X	14"
39-1622	24	2X	11"
39-1623	25	2 $\frac{1}{4}$ X	9"
39-1624	26	2 $\frac{1}{2}$ X	7"
39-1625	28	3X	5"

44. Clips-on Opticaid® Magnifier -USA

Magnifier has flexible wire clip for use with any eyeglass frame. Scratch-proof optical quality acrylic, prismatic lens.



ITEM #	POWER	F/DIST
39-1661	1 $\frac{1}{2}$ X	20"
39-1662	1 $\frac{3}{4}$ X	14"
39-1663	2X	10"
39-1664	2 $\frac{1}{4}$ X	8"
39-1665	2 $\frac{1}{2}$ X	6"
39-1666	3 $\frac{1}{2}$ X	4"

45. Magnifying Specs- USA

Can be worn alone or over eyeglasses. Scratch-proof optical quality acrylic, prismatic lens.



ITEM #	STYLE	POWER	F/DIST
39-1631	#2	1 $\frac{1}{2}$ X	20"
39-1632	#3	1 $\frac{3}{4}$ X	14"
39-1633	#4	2X	10"
39-1634	#5	2 $\frac{1}{4}$ X	8"
39-1635	#7	2 $\frac{3}{4}$ X	6"
39-1636	#10	3 $\frac{1}{2}$ X	4"

46. Spring Clip Opticaid® Magnifier- USA

May be used with any metal or plastic eyeglass frames. Scratch proof optical quality acrylic, prismatic lens.



ITEM #	POWER	F/DIST.
39-1641	1 $\frac{1}{2}$ X	20"
39-1642	1 $\frac{3}{4}$ X	14"
39-1643	2X	10"
39-1644	2 $\frac{1}{4}$ X	8"
39-1645	2 $\frac{3}{4}$ X	6"
39-1646	3 $\frac{1}{2}$ X	4"

47. B & L® Spectacle Loupes-Single/Double Lens

Single lens spectacle loupe clips on to a frame and flips out when not in use. Double lens are two separate lenses that may be used together or singly.



ITEM #	POWER	F/DIST.
39-1671	3X	3 $\frac{1}{2}$ "
39-1672	4X	2 $\frac{1}{2}$ "
39-1673	5X	2"
39-1674	7X	1 $\frac{1}{2}$ "
39-1675	3X, 5X	3 $\frac{1}{2}$ " & 2"
39-1676	4X, 7X	1 $\frac{1}{2}$ " & 1 $\frac{1}{2}$ "



PLATING

■ Activated Carbon	201
■ Binding Wires- Copper	206
■ Carbon Treatment Kit	201
■ Ceramitation	206
■ Degussa Gold Plating	201
■ Degussa Rhodium	200
■ Ear Piercing	207
■ Electric Hot Plate	204
■ Electrocleaner	205
■ Enamels	207
■ Fume Hood	203
■ Glass Beakers & Covers	204
■ Ikohe Enameling Kiln	207
■ Krohn Gold Plating Solutions	205
■ Krohn Liquid Electrocleaner	205
■ Krohn Rhodium Plating Solutions	205
■ Krohn Tivabrite	205
■ Krohn Tivaclean	206
■ Latex Gloves	203
■ Mini-Plating System	202
■ Pen Plating Solutions	208
■ Plated Ear Stud	204
■ Plating Anodes	206
■ Plating Racks	203
■ Plating Rectifier 30A	204
■ Plating Thermometer	204

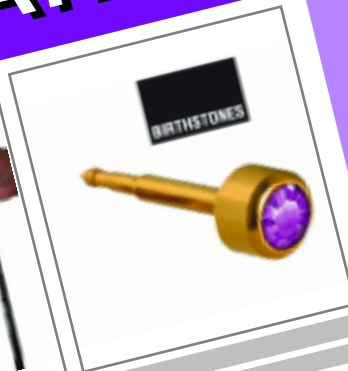

■ Stainless Steel Beakers	204
■ Stop-off DYKEM Blue	202
■ Wieland Pen Plating Solutions	202
■ Wieland Plating Anodes	204
■ Wieland Rhodnette Pen Plater	202



Plating Made Easy

by Hoover and Strong

A beginners guide on plating desirable colors in gold, silver and rhodium. Explains and describes procedures on electrostripping, electroplating and troubleshooting.

BK-438 (Spiralbound – 23 pages)

 **ikohe WIELAND**
 **ni-na**





1. "DEGUSSA RHODIUM" IS NOW UMICORE RHODUNA® RHODUNA J1, J2, TD & SL-C

RHODUNA J1, J2 & TD

The new trademark stands for the excellent quality of the Rhodium products from Umicore Galvanorechnik GmbH. The new packaging is unique, with the "Umicore color" and is shrink sealed to give you the protection and security of the world's most recognized brand.

Fields of Application:

- Carat jewelry • Costume jewelry
- Watches • Spectacle Frames
- Tableware • Technical articles



ITEM #	DESCRIPTION
40-1211	SL-C - 1 GRAM / 50ML - RACK
40-1212	J1- 2 GRAM / 100ML
40-1213	J2- 2 GRAM / 100ML
40-1214	TD - 2 GRAM / 100ML
40-1215	REPLENISHER
40-1216*	BLACK-470 2 GRAM / 100ML
40-1217*	BLACKENING AGENT 20ML

ELECTROLYTES FOR PLATING BATHS

RHODIUM J1: Brilliant white, very light coatings up to 0.3um layer thickness for decorative applications. Especially suitable for jewelry, watches and spectacle frames. May be used for rack and barrel plating.

RHODIUM J2: Brilliant white, very light coatings up to 0.3um layer thickness for decorative applications. May be used for rack and barrel plating. Distinct advantages are no adhering hydrogen bubbles and no staining due to the use of a special wetting agent.

RHODIUM TD: Ultra white bright coatings for decorative and technical applications. High deposition capacity, good covering speed and excellent throwing power. May be used for rack and barrel plating.

RHODIUM SL-C: Brilliant white, very light coatings up to 0.3um layer thickness for decorative applications. May be used for rack and barrel plating.

RHODIUM 470: **To achieve blue rhodium coatings**
Black
For decorative coatings of blue to anthracite or deep black color up to 0.3um thickness. Deposited coatings have a good color constancy and retain their brightness. To achieve ideal result the bath make up 100 ml of black rhodium 470 and 20ml of black rhodium blackening agent are required for 1 liter of black rhodium bath to deposit a blue color.

* 40-1216 & 40-1217 to be ordered together



2. "DEGUSSA RHODIUM" IS NOW UMICORE RHODUNA® RHODUNA 271, 272, 275 & SL-C



PLATING ELECTROLYTES FOR PEN PLATING

RHODIUM 271 : Electrolyte, ready to use for selective decorative pen or brush plating. Abrasion resistant light and bright coating. High plating speed and fast covering power.

RHODIUM 272 : Electrolyte, ready to use for selective decorative pen or brush plating. Abrasion resistant bright ultra white coating. High covering power and deposition speed, without the appearance of stripes at the edges.

RHODIUM 275 : Electrolyte, ready to use for selective decorative pen or brush plating. Abrasion resistant ultra dark reflective black coating for contrast designing. High covering power and plating speed.

RHODIUM SL-C : Electrolyte, ready to use for selective decorative pen or brush plating.

ITEM #	DESCRIPTION
40-1221	SL-C- 1 GRAM / 50ML - PEN
40-1222	271- 2 GRAM / 100ML
40-1223	272- 2 GRAM / 100ML
40-1224	275- 2 GRAM / 100ML



3. UMICORE GOLD PLATING SOLUTION AURUNA® 250, 261, 262, 263 & 264

PLATING ELECTROLYTES FOR PEN PLATING

AURUNA® 250 : Ready to use (pH approx 0.6) special bath for direct gold-plating of stainless steel. Coating color yellow approx. 3N

AURUNA® 261 : Ready to use (pH approx 7). Coating color pale yellow approx. 1N

AURUNA® 262 : Ready to use (pH approx 3). Coating color neutral yellow approx. 1N

AURUNA® 263 : Ready to use (pH approx 7). Coating color rich deep yellow, fine gold color

AURUNA® 264 : Ready to use (pH approx 9). Coating color rose approx. 4-5N

ITEM #	DESCRIPTION	CONTENTS
40-1231	250 YELLOW	2G/100ML
40-1232	261 PALE LIGHT-YELLOW	2G/100ML
40-1233	262 NEUTRAL YELLOW	2G/100ML
40-1234	263 RICH DEEP YELLOW	2G/100ML
40-1235	264 ROSE	2G/100ML

Plating Anodes

An anode is a strip of metal of high purity that directs current from the positive terminal of the plating rectifier to the bath.

For more details see page #204



4. Karbo-Clear™ Rhodium Treatment Kit

Proper maintenance of your rhodium plating solution is essential to the production of a bright-white deposit. Wax or other stop offs and cleaners or soaps may introduce soluble organic contaminants into your Rhodium Plating Solution, which will cause a darkening of the rhodium deposit.

KIT CONSISTS OF:

1. TREATMENT TANK
2. ACTIVATED CARBON
3. GLASS STIRRER
4. FILTER PAPER
5. PLASTIC FUNNEL
6. FILTRATION TANK



ITEM #	DESCRIPTION
40-1255	RHODIUM TREATMENT KIT



AURUNA® 250, 261, 262, 263, 264

Pencil plating is used for partial plating of jewelry. With pencil gold-plating, small areas of parts are selectively gold-plated. Use a pen plater with a fiber tip point soaked with the respective gold bath. Applications include decorative designs in contrasting colors.



Fields of Application:

- Carat jewelry
- Costume jewelry
- Watches
- Spectacle frames
- Tableware
- Charms and Pendants
- Gold pens

5. Activated Carbon

A solution to remove organic contamination from rhodium and gold plating baths.



ITEM #	DESCRIPTION
40-1251	ACTIVATED CARBON- 3 OZ
40-1253	FILTER PAPER 13" BX/10



Guidelines for Rhodium Plating

Rhodium plating baths need to be prepared in a clean and well ventilated area. To achieve an ultra bright white color articles must have a nickel underplate or the finish will be unsatisfactory. Use only platinized titanium anodes when plating rhodium.

Rhodium solutions must be protected from every possible source of contamination. If a solution is contaminated proper adhesion will not occur. Poor adhesion may be due to plating at too high or too low a voltage. When rhodium solutions are not in use they should be stored in a glass beaker with a snug fitting cover.



WIELAND



Unit Includes: Rectifier unit, red anode pen with fiber tip, black lead wire with clip, five regular fiber tips, one glass container and instructions. (Plating solution not included)



6. Rhodnette Pen Plater

Suitable for both shop and industry. The ergonomically designed electrode pen ensures easy handling and the platinum contact guarantees consistent metal deposition. This fiber tipped pen may be used for partial electroplating of jewelry and other small items. It makes two tone effects much easier to produce and it is not always necessary to resort to masking areas.

ITEM #	DESCRIPTION
40-1030	RHODINETTE PEN PLATER 110V / 220V / 6W

Spares for Rhodnette

ITEM #	DESCRIPTION
40-1031	RHODINETTE PLATING PEN - GERMAN
40-1032	FIBER TIP -REGULAR
40-1033	FIBER TIP -SUPER POINT
40-1034	FIBER TIP -YELLOW
40-1035*	FINE POINT CHISEL TIP
40-1036	WIELAND STOP-OFF PEN
40-1037*	CLAMP WIRE FOR RHODINETTE
40-1038*	CONTACT PLATE
40-1040*	GLASS JAR- YELLOW
40-1041*	GLASS JAR- BLACK
40-1042*	GLASS JAR- RED

* picture not shown

WIELAND



WIELAND 7. Pen Plating Solutions

Suitable for use with all pen platers for designer work. These are specially formulated solutions for partial electroplating articles of jewelry. Plating layers applied by these solutions are relatively thin.

Please call for pricing.

ITEM #	DESCRIPTION	
40-1044	FINE GOLD	2G/100ML
40-1045	YELLOW GOLD	2G/100ML
40-1046	PALE GOLD	2G/100ML
40-1047	RED GOLD	2G/100ML
40-1051	BRIGHT RHODIUM	2G/100ML
40-1052	BLACK RHODIUM	2G/100ML
40-1055	NICKEL	100ML
40-1056	COPPER	100ML

Wieland Gold and Rhodium plating baths are available. Call for details

8. Stop-off DYKEM Blue

A very effective solution that may be used to mask areas that do not need to be plated. May be cleaned after use with acetone.



ITEM #	DESCRIPTION
40-1197	DYKEM BLUE 8 OZ

Guidelines for Electroplating



Electroplating is a process of metal deposition in a thin layer over an item of jewelry. Surface finish and cleaning is of utmost importance to get the best results in electroplating. It is the quality of finish prior to plating that dictates the final appearance. From practical experience it is a known fact that all items after buffing and polishing must be immersed in an ultrasonic unit for at least 20 minutes. Subsequently the items must be steam cleaned before plating. When mixing plating solutions, always add salt to the solution. Never add water to the salt or concentrated solution.

Safety Instructions: • Work in a well ventilated and clean area • Wear proper eye and skin protection • Do not ingest or inhale fumes • All chemicals must be labeled and stored in tightly closed containers • Obey federal, state and local regulations for disposal of spent chemicals and waste



9. Plating Rectifier 30A with Micro Pen Plater

A unit that features both a plating rectifier and a pen plater.

Plating Rectifier: This is the power source for direct current that is needed for electroplating and electro stripping. Solid state circuitry delivers filtered DC output. A variable voltage and amperage determines the size of the bath and the surface area that can be plated. The control panel has an amp/volt meter, regulator and an on/off switch.

Micro Pen Plater: This is a built-in unit with a fiber tipped pen. It is designed to plate small and hard to reach areas in jewelry, designs and to touch up repairs.

ITEM #	DESCRIPTION
40-1012	RECTIFIER / PEN PLATER SET - 110V
40-1013	RECTIFIER / PEN PLATER SET - 220V
40-1014	RED / BLACK LEAD WIRE
40-1015	PLATING PEN WITH CLAMP (RED & BLACK)



Unit Includes: Rectifier 30A output continuous duty, 12V-DC Maximum 4.5 gal. plating baths, one red, one black lead wire with alligator clips.
Dimensions: 12 x 14 x 9" Wt. 14lb
 40-1015: Plating pen to be ordered separately

10. Plating Rectifier 30A

A heavy duty rectifier suitable for both electroplating and electro stripping operations. Filtered DC output, with precision voltage/amperage regulation. A remarkable system that features both a plating rectifier and a pen plater. The control panel has an amp/volt meter, regulator and an on/off switch. Maximum 4.5 gal. plating baths.

ITEM #	DESCRIPTION
40-1017	PLATING RECTIFIER 110V / 220V-30A
40-1014	RED/BLACK LEAD WIRE



Unit Includes: Rectifier 30A output heavy duty, 12V-DC Maximum 4.5 gal. plating baths, one red, one black lead wire with alligator clips.
Dimensions: 12 x 14 x 10" Wt. 14 lb

11. Mini-Plating System

Features:

- Compact, lightweight table top unit for electrocleaning, electrostripping and electroplating
- Ideal for plating silver, gold and rhodium
- Includes 600 ml beakers for electrocleaning, neutralizing and plating
- Automatic bath agitation
- Integrated circuitry with voltage/current regulation
- Dual voltage 110/220V - switchable

40-1021: Three Beaker Plating Unit Dimensions: 330 x 210 x 290mm Wt. 10.5 lbs.
 Rectifier 12 Amps / 8 volts



ITEM #	DESCRIPTION
40-1021	PLATING UNIT -110V/220V

12. Fume Hood



Bench Fume Hood with light

- Economical lightweight table top unit for use when plating or electro-stripping
- Constructed in epoxy coated steel
- Includes a suction motor and internal light
- Supplied with hoses and clamps
- Dimension 310 x 280 x 290 mm. Wt. 22 lbs.

ITEM #	DESCRIPTION
40-1028	FUME HOOD 110V
40-1029	FUME HOOD 220V



13. Plating Anodes- Germany

Select the correct anode for the plating bath. Rhodium plating solutions use platinized titanium as anodes. Wieland plating anodes are of high purity and excellent for immersion in plating solutions. Au-Gold, Rh-Rhodium, Ag -Silver



BEAKER ANODE

ITEM #	DESCRIPTION		
40-1061	SPECIAL STEEL	110 X 60MM	AU
40-1063	PURE SILVER	100 X 50MM	AG
40-1064	PURE SILVER	170 X 100MM	AG
40-1066	PLATINIZED TITANIUM 1.5μ	100 X 30MM	RH
40-1067	PLATINIZED TITANIUM 1.5μ	110 X 60MM	RH
40-1068	PT. TITANIUM BEAKER ANODE FOR 600ML		RH
40-1069	PT. TITANIUM BEAKER ANODE FOR 1200ML		RH

14. Plating Anodes

An anode is a strip of metal of high purity that directs current from the positive terminal of the plating rectifier to the bath. Each type of anode needs to be used with an electroplating solution. Copper, silver and nickel anodes dissolve in the bath to replace the metal ions that are deposited on the workpiece.



ITEM #	DESCRIPTION
40-1081	PURE NICKEL 1" X 6"
40-1082	PURE COPPER 1" X 6"
40-1086	PLATINIZED TITANIUM T-BAR 10 3/4" X 4"

15. Electric Hot Plate

40-1091: Black enamel finished, seamless all steel exterior. 5 1/2" diameter tubular heating element, 825w. UL listed.

40-1092: Chrome finished, easy to clean seamless all steel exterior. Twin plate 5 1/2" diameter tubular heating element, 825w. ach. UL listed.



ITEM #	DESCRIPTION
40-1091	SINGLE HOT PLATE 110V
40-1092	DOUBLE HOT PLATE 110V

16. Glass Beakers & Covers

Useful for liquid measurement, these beakers are graduated and provided with spouts for easy pouring. Covers provide tight seals and protect plating solutions from spills or contamination.

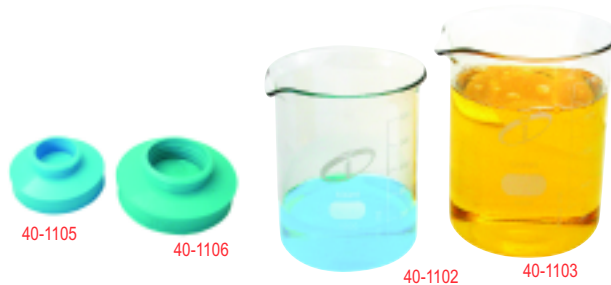

ITEM #	DESCRIPTION
40-1101*	BEAKER-50ML
40-1102	BEAKER- 600ML
40-1103	BEAKER-1000ML
40-1105	COVER FOR 600ML
40-1106	COVER FOR 1000ML

* PICTURE NOT SHOWN

17. Stainless Steel Beakers

Two sizes of beakers are available. When a lead wire from the rectifier is connected to the beaker, it acts as the anode for electro stripping and electro cleaning.



ITEM #	DESCRIPTION
40-1111	SS BEAKER-600ML
40-1112	SS BEAKER- 1200ML

18. Plating Thermometer

A glass thermometer resistant to chemicals. Temperature range 20°-232° F.



ITEM #	DESCRIPTION
40-1093	GLASS THERMOMETER

19. Electrocleaner

Surface is cleaned leaving it bright for immersion in the plating bath. A special formula of a combination of chemicals in powder form. May be diluted by mixing with distilled water.



ITEM #	DESCRIPTION
40-1095	ELECTROCLEANER-1 LB
40-1096	ELECTROCLEANER-2 1/2 LB



20. Pen Plating Solutions

These plating solutions plate directly on all types of metals. Use a porous fiber tip pen with a pen plating rectifier for creating artistic designs.

RH- Rhodium
Contents: 2 oz.



ITEM #	DESCRIPTION	ITEM #	DESCRIPTION
40-1171	14K GOLD ¼G	40-1177	ROSE GOLD 1G
40-1172	14K GOLD 1G	40-1178	GREEN GOLD 1G
40-1173	18K GOLD ¼G	40-1181	RH 1G-CONC.
40-1174	18K GOLD 1G	40-1182	RH 2G-CONC.
40-1175	24K GOLD ¼G	40-1183	RH BLACK 1G
40-1176	24K GOLD 1G		

21. Krohn Liquid Electrocleaner

This ready-to-use electro cleaning solution is primarily used to clean castings and articles prior to being plated.



ITEM #	DESCRIPTION
40-1191	ELECTROCLEANER -1 QT.

Umbrella Type Ring Rack

Stainless steel frame plastic coated rack. Hooks are adjustable and evenly spaced to hold articles of jewelry for cleaning or plating.

See page # 104

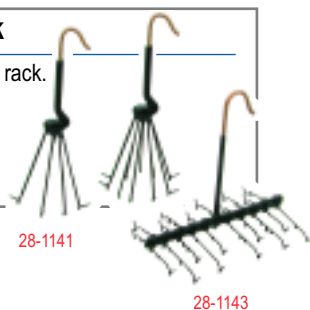

Jax Metal Finishing Solutions

These metal finishing, cleaning and polishing solutions are easy to use, produce consistent results and require no heat or electricity. All solutions are water based and non-flammable.

Available on special order.

22. Krohn Rhodium Plating Solutions

Rhodium plated articles exhibit a hard, brilliant white, highly reflective surface. Care must be exercised not to use any stainless or ferrous metal articles as it will contaminate the bath. To plate silver, copper or bronze alloys, articles must first have a primary nickel plate. Use with platinized titanium anodes.

Rhodium Replenisher

Use this solution to replenish when the chemical balance is depleted in the rhodium plating bath.



ITEM #	DESCRIPTION
40-1161	RHODIUM ½G-8 FL. OZ (READY TO USE)
40-1162	RHODIUM 1G-1 PINT (READY TO USE)
40-1163	RHODIUM 2G-1 QT. (READY TO USE)
40-1165	RHODIUM 1G (CONCENTRATE)
40-1166	RHODIUM 2G (CONCENTRATE)
40-1167	REPLENISHER 1G
40-1168	REPLENISHER 2G

23. Krohn Gold Plating Solutions

Specifically formulated for each grade of gold. These solutions are pre-mixed and ready to use. Articles exhibit a bright reflective finish. Use with stainless steel or fine gold anodes. Contains one pennyweight of pure gold per quart. Contents 1 qt.



ITEM #	DESCRIPTION	ITEM #	DESCRIPTION
40-1151	14K GOLD	40-1157	18K GREEN
40-1152	18K GOLD	40-1158	PINK
40-1154	24K GOLD	40-1159	HAMILTON

24. Krohn Tivabrite

An electro stripping powder to be mixed with water (4 oz to a gallon) with an equal amount of sodium cyanide. The solution is used for stripping worn plating before replating. Leaves yellow gold bright, clean and polished. For chemicals please contact your supplier.



ITEM #	DESCRIPTION
40-1193	TIVABRITE -1 LB.

25. Krohn Tivaclean

An electro cleaning concentrate for both metals and plastic. When Tivaclean is mixed with water (8 oz to a gallon) the color changes from orange to a fluorescent green. It contains an anti-foaming agent for low sudsing and a deodorant to suppress odor. It is biodegradable with a non-caustic pH of 9-10. Use at room temperature.



ITEM #	DESCRIPTION
40-1192	TIVACLEAN-1 LB.



26. Plating Racks

Well designed, in rows, with hooks, these racks are made of heavy gauge poly coated copper for protection when immersed in plating baths.



ITEM #	DIA.	ROWS	HOOKS
40-1121	2"	1	8
40-1122	2"	2	16
40-1123	2"	3	24
40-1124	3"	1	12
40-1125	3"	2	24
40-1126	3"	3	36
40-1127	4"	1	16
40-1128	4"	2	32
40-1129	4"	3	48

Guidelines for Enameling

Enamels are available in lead free powder of 80 mesh particle size. It is important to pre-test the colors prior to using. Printed colors do not always perfectly match the product they represent. There may be slight variations in color from batch to batch. The 80 mesh standard particle size is normally applied by sifting. It can also be mixed with water and charged on to a substrate surface. These enamels are for use on metals and glass. Normal firing temperature range is 1400°F.

30. Ceramitation - Low Temperature Hard Curing Resin

A remarkably versatile decorative resin that is full of vibrant color when cured. Its hardness is virtually equivalent to hard fired enamel. May be sprayed or brushed on almost any surface- metal, porcelain, glass or rock. Ceramitation may be thinned with a special thinner. This product is a two-part system, a) Color and b) Catalyst. Cures in 30-45 minutes at 200°F (120°C) in an electric oven.



ITEM #	DESCRIPTION
40-1331	6 COLOR SET**
40-1332	CATALYST - 16 OZ.
40-1333	CATALYST - 8 OZ.
40-1334	CATALYST - 4 OZ.
40-1335	THINNER -16 OZ.

** 40-1331: Set consists of 6 transparent colors -2 oz (red, brown, blue, green, yellow & clear) and catalyst -4 oz.

27. Copper Wires

Pure Copper Wire, soft and pliable, for suspending articles of jewelry in plating baths. Do not use for rhodium or electro stripping.



ITEM #	GAUGE	INCH	WT.
40-1131	18	0.040	1 LB
40-1132	20	0.032	1 LB
40-1133	22	0.025	1 LB
40-1134	24	0.020	1 LB

28. Latex Gloves

Protect fingers and hands with these disposable latex gloves. Essential when working with plating solutions. Do not use if you are NRL sensitive.



ITEM #	DESCRIPTION
45-1081	LATEX GLOVES -SMALL
45-1082	LATEX GLOVES -MEDIUM
45-1083	LATEX GLOVES -LARGE

29. Liver of Sulphur

When dissolved in hot water, it may be used to oxidize most metals. Available in lump form.



ITEM #	DESCRIPTION
40-1198	LIVER OF SULPHUR - 4 OZ.
40-1199	LIVER OF SULPHUR - 8 OZ.

Opaque Colors - 2 oz

ITEM #	COLOR
40-1341	WHITE
40-1342	BLACK
40-1343	RED
40-1344	CHINESE RED
40-1345	BLUE
40-1346	ISRAELI BLUE
40-1347	YELLOW

Transparent Colors - 2 oz

40-1351	RED
40-1352	BROWN
40-1353	BLUE
40-1354	GREEN
40-1355	YELLOW
40-1356	CLEAR



31. Enamels

A range of brilliant colors that can be effectively used to create artistic designs on jewelry. After application on gold, silver and copper the articles, when fired, will convert the enamel into a hard glossy coating.

ITEM #	DESCRIPTION
40-1311	6 COLOR -SET
40-1312	BLACK - 2 OZ.
40-1313	WHITE - 2 OZ.
40-1314	RED - 2 OZ.

ITEM #	DESCRIPTION
40-1315	BLUE -2 OZ.
40-1316	YELLOW -2 OZ.
40-1317	GREEN -2 OZ.

40-1311: Set consists of 6 colors
(black, white, red, blue, yellow and green-2 oz ea.)

Guide line for enameling see page # 206

32. Ikohe Enameling Kiln

The digital enameling kiln fires enamel, silver, clay, decals, china paint and glass in minutes. Maximum temperature 2000°F/1093°C. A large, brightly lit display prompts for firing rate, temperature and hold time. The high tech ceramic firing chamber is wrapped in a heavy gauge steel case. Electrical controls are conveniently mounted on the front panel. Certified to CSA & UL Standard 499.

ITEM #	DESCRIPTION
27-1176	ENAMELING KILN 110V
27-1177	ENAMELING KILN 220V

Also Available Enameling Kiln with Bead Door

Specifications:

Model: SC-2
 Max temp: 2000°F/ 1093°C
 Interior Dimensions: 8" X 5¼" X 7¼"
 Exterior Dimensions: 13¼" X 14" X 15½"
 Electrical: 110V/12 A/1.5kw
 Weight: 36 lbs.



The Art of Fine Enameling

by Karen L. Cohen

Read the fundamentals of enameling.
 61-1213 (Softcover – 160pages)



33. NI-NA Ear Studs- Counter Single Display

- 24 ct Gold Plated • Medical Stainless Steel • Austrian Stones
- Individually packed in a pair

ni-na

100% Sterilized Ear Piercing Studs

Available in individual carded pairs

Stones	Style	BX/ DZ	
		Mini	Regular
Garnet	Gold	64-821GM	64-841G
	White	64-821WM	64-841W
Amethyst	Gold	64-822GM	64-842G
	White	64-822WM	64-842W
Aquamarine	Gold	64-823GM	64-843G
	White	64-823WM	64-843W
Crystal	Gold	64-824GM	64-844G
	White	64-824WM	64-844W
Emerald	Gold	64-825GM	64-845G
	White	64-825WM	64-845W
Alexandrite	Gold	64-826GM	64-846G
	White	64-826WM	64-846W
Ruby	Gold	64-827GM	64-847G
	White	64-827WM	64-847W
Peridot	Gold	64-828GM	64-848G
	White	64-828WM	64-848W
Sapphire	Gold	64-829GM	64-849G
	White	64-829WM	64-849W
Rose	Gold	64-830GM	64-850G
	White	64-830WM	64-850W
Topaz	Gold	64-831GM	64-851G
	White	64-831WM	64-851W
Blue Zircon	Gold	64-832GM	64-852G
	White	64-832WM	64-852W
Blue Eye	Gold		64-853G
	White		64-853W

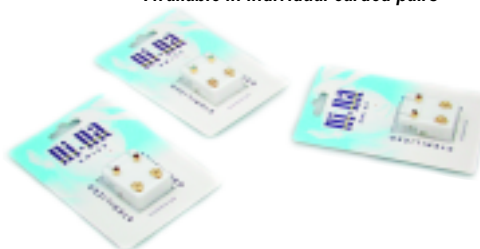

Ear Stud Gun Kit

- Cartridge channel holds cartridge securely
 - Ergonomic design for a comfortable grip
 - Easy- to-clean chrome finish
 - Light weight for effortless handling
 - Instrument never touches the customer's ear
- Kits Includes:**
- Universal ear piercing instrument
 - Three adaptors- large, regular and mini
 - Non-toxic marking pen
 - Ear care gel and sterile pads
 - One pair of ear studs
 - Operating instructions on a CD



ITEM #	DESCRIPTION
64-8000	EAR STUD GUN KIT













34. Plated Ear Studs- Boxed











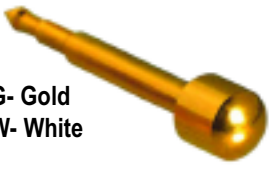

A wide selection of best selling ear studs. Sizes include regular and mini. **Bx/dz.**

BIRTHSTONES BEZEL REGULAR  G- Gold W- White	Garnet 64-001G 64-001W 	Crystal 64-004G 64-004W 	Ruby 64-007G 64-007W 	Rose 64-010G 64-010W 	Set- one each of all 12 stones	
	Amethyst 64-002G 64-002W 	Emerald 64-005G 64-005W 	Peridot 64-008G 64-008W 	Topaz 64-011G 64-011W 		Assorted 64-013G 64-013W 
	Aquamarine 64-003G 64-003W 	Alexandrite 64-006G 64-006W 	Sapphire 64-009G 64-009W 	Blue Zircon 64-012G 64-012W 		Blue Eye 64-014G 

BIRTHSTAR TIFFANY REGULAR  G- Gold W- White	January 64-301G 64-301W 	April 64-304G 64-304W 	July 64-307G 64-307W 	October 64-310G 64-010W 	Set- one each of all 12 months	
	February 64-302G 64-302W 	May 64-305G 64-305W 	August 64-308G 64-308W 	November 64-311G 64-011W 		Assorted 64-313G 64-313W 
	March 64-303G 64-303W 	June 64-306G 64-306W 	September 64-309G 64-309W 	December 64-312G 64-012W 		

BIRTHSTONES BEZEL-MINI  G- Gold W- White	Garnet 64-201GM 64-201WM 	Crystal 64-204GM 64-204WM 	Ruby 64-207GM 64-207WM 	Rose 64-210GM 64-210WM 	Pearl 64-214GM 64-214WM 	Set- one each of all 12 stones	
	Amethyst 64-202GM 64-202WM 	Emerald 64-205GM 64-205WM 	Peridot 64-208GM 64-208WM 	Topaz 64-211GM 64-211WM 	Star 64-215GM 64-215WM 		Assorted 64-213GM 64-213WM 
	Aquamarine 64-203GM 64-203WM 	Alexandrite 64-206GM 64-206WM 	Sapphire 64-209GM 64-209WM 	Blue Zircon 64-212GM 64-212WM 	Heart 64-216GM 64-216WM 		Regular 64-217GM 64-217WM 

SHAPE STONES  G- Gold W- White	Starlite 64-601G 64-601W 	Flowerlite 64-604G 64-604W 	Semi-Precious	Pearl 64-401G 64-401W 	Black Onyx 64-404G 64-404W 	Set- one each of all 12 semi-precious stones
	Heartlite 64-602G 64-602W 	Assorted 64-605G 64-605W  Set- one each of all 12 shape stones		Red Coral 64-402G 64-402W 	Assorted 64-405G 64-405W 	
	Crosslite 64-603G 64-603W 			Turquoise 64-403G 64-403W 		

SHAPES  G- Gold W- White	Star 64-501G 64-501W 	Triangle 64-504G 64-504W 	Crescent Moon 64-507G 64-507W 	REGULAR	Set- one each of all 8 shapes	
	Heart 64-502G 64-502W 	Square 64-505G 64-505W 	Flower 64-508G 64-508W 			Regular 64-701G 64-701W 
	Cross 64-503G 64-503W 	Full Moon 64-506G 64-506W 	Assorted 64-509G 64-509W 			Mini 64-702GM 64-702WM 



PLIERS & SHEARS

■ Bench Shears with Handle	222
■ Bergeon Bracelet Cutter	219
■ Bergeon Sprue Cutter	219
■ Brown Shears	222
■ Compound Sprue Cutter	219
■ GRS Ring Size Cutter	222
■ Keiba Cutter	219
■ Keiba Cutter with Lock	216
■ Lap Joint Pliers- Germany 4 1/2" /115mm	212
■ Lindstrom® Bio-Spring Pliers-Rx Series	211
■ Lindstrom® Diagonal Cutters- Y/Handle	211
■ Lindstrom® Pliers- White Handle	220
■ Marking Plier	219
■ Maun Type Cutter	215
■ Nylon Pliers- 5 1/2"/140mm	220
■ Parallel Pliers- Maun	219
■ Pastorino Sprue Cutter	220
■ Plier Organizers	218
■ Pliers & Cutters -Germany	217
■ Pliers & Cutters -Value	220
■ Pneumatic Sprue Cutter	222
■ Portable Ring Shears	215
■ Regular Pliers-5" German	216
■ Shape Forming Pliers	221
■ Shears -German	221
■ Sheet Shears	221



■ Slim-Line Pliers- German	214
■ Special Features Pliers & Cutters	217
■ Special Pliers- German	214
■ Straight & Oblique Cutter-Swiss	218
■ Stainless Steel Pliers-Japan	212
■ Superlight Pliers-4 1/2"	219
■ Swiss Sprue Cutter	222
■ Universal Shears with Spring	221
■ Wire Bending Plier	210
■ Xuron Series Premium Quality Shears	210
■ Y2K Series Pliers & Cutters -4 1/2"	213



Classical Loop-in-Loop Chains & Their Derivatives

by **Jean Reist Stark & Josephine Reist Smith**
 Clearly presented procedures for making a variety of chains based on classic loop-in-loop techniques. Details 34 projects with black & white photos and drawings to guide you through each step. Tools and equipment for each project are specified and appropriate clasps for each chain type are suggested. This is the definitive book on the subject.

61-1259 (Hardcover-190 pages)

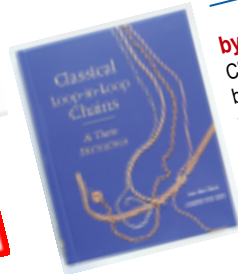

PLIERS & SHEARS



Series Premium Quality Shears

Speciality Micro Shear flush cutting action delivers an ultra precision edge on soft metals and soft wire. Manufactured from stamped alloy steel with induction hardened jaws.

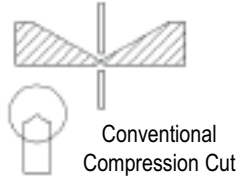

A patented blade by-pass shear action results in a clean square cut edge.

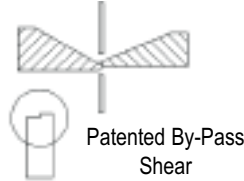

This unique shear action contributes to an effortless operation. Features close fitting post and pivot screw. Light touch spring return and comfortable non-slip grips.

2. 410 Micro-Shears



4.8" long, jaws (9x12mm) premium grade. Optimized for work in high density areas. Reliable flush cuts for soft wire up to 20 ga. (0.8mm).

ITEM #	DESCRIPTION
41-1011	410 MICRO-SHEAR F/CUTTER

4. LX Micro-Shears

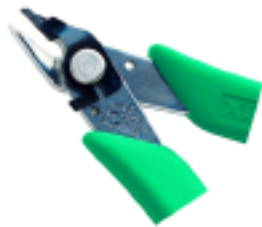

4.8" long, jaws (9 x 12mm). Slim tapered head for cuts in confined areas. Flush cuts for soft wire up to 19 ga. (1.00mm).

ITEM #	DESCRIPTION
41-1012	LX MICRO-SHEAR F/CUTTER

Micro-Shear® Blade By-Pass Cutting Vs Compression Cutting

The term "Micro-Shear®" refers to Xuron's patented method of blade by-pass cutting. Micro-Shear® flush cutters, as opposed to traditional compression cutters, have cutting edges that are designed to by-pass each other rather than meet edge to edge. You can see the blade by pass if you examine the head of any shears with the tool in its fully closed position. The "shear cut" resulting from by-pass cutting blades produces a flat, clean flush-to surface cut end while reducing the manual cutting effort 50% as compared to "edge-to-edge".

1. 2175 Maxi - Shear



6" long, jaws (12 x 17mm). Features extra long tapered head for specific areas. Flush cut for soft wire up to 14 ga. (1.6mm).

ITEM #	DESCRIPTION
41-1016	2175 MAXI-SHEAR FLUSH CUTTER

3. 9100 Oval Head



5" long, jaws (9x12mm) sturdy oval shaped head for durability. Clean flush cuts for soft wire up to 14 ga. (0.8mm).

ITEM #	DESCRIPTION
41-1017	9100 OVAL HEAD FLUSH CUTTER

5. 9200 Tapered Head



5" long, jaws (9x12mm). Slim tapered head for work in restricted areas. Precise flush cuts for soft wire up to 14 ga. (1.6mm).

ITEM #	DESCRIPTION
41-1018	9200 TAPERED HEAD F/CUTTER

6. 170-II Micro-Shears



5" long, jaws (9x12mm). Ultra slim profile for access in high density areas, flush cuts for soft wire up to 20 ga. (0.8mm).

ITEM #	DESCRIPTION
41-1019	170-II MICRO-SHEAR F/CUTTER



PLIERS & SHEARS

7. Lindstrom® Diagonal Cutters- Sweden

Premium quality Swedish diagonal cutters for use in jewelry and precision crafting. Black anodized, keen cutting edges have adjustable screw lap joints for accurate alignment. Cushion grip handle is proportional for the applied leverage. Double leaf springs keep the jaws apart.



ITEM #	DESCRIPTION	STYLE	A	B	C
41-1040	MICRO BEVEL	8140	4 ¹ / ₈ "/110MM	3 ³ / ₈ "/10MM	3 ³ / ₈ "/10MM
41-1041	FLUSH CUT	8141	4 ¹ / ₈ "/110MM	3 ³ / ₈ "/10MM	3 ³ / ₈ "/10MM
41-1042	ULTRA	8142	4 ¹ / ₈ "/110MM	3 ³ / ₈ "/10MM	3 ³ / ₈ "/10MM
41-1045	ULTRA	8145	4 ¹ / ₈ "/110MM	3 ³ / ₈ "/10MM	3 ³ / ₈ "/10MM
41-1050	MICRO BEVEL	8150	4 ⁷ / ₁₆ "/112.5MM	1 ¹ / ₂ "/12.5MM	1 ¹ / ₂ "/12.5MM
41-1051	FLUSH CUT	8151	4 ⁷ / ₁₆ "/112.5MM	1 ¹ / ₂ "/12.5MM	1 ¹ / ₂ "/12.5MM
41-1055	ULTRA	8155	4 ⁷ / ₁₆ "/112.5MM	1 ¹ / ₂ "/12.5MM	1 ¹ / ₂ "/12.5MM
41-1060	MICRO BEVEL	8160	5"/125MM	5 ⁵ / ₈ "/16MM	5 ⁵ / ₈ "/16MM

8. Lindstrom® Pliers- Sweden

Made of the finest Swedish steel, these high quality pliers are compact due to their close fitting box joints. All have double leaf springs and comfort styled handles.

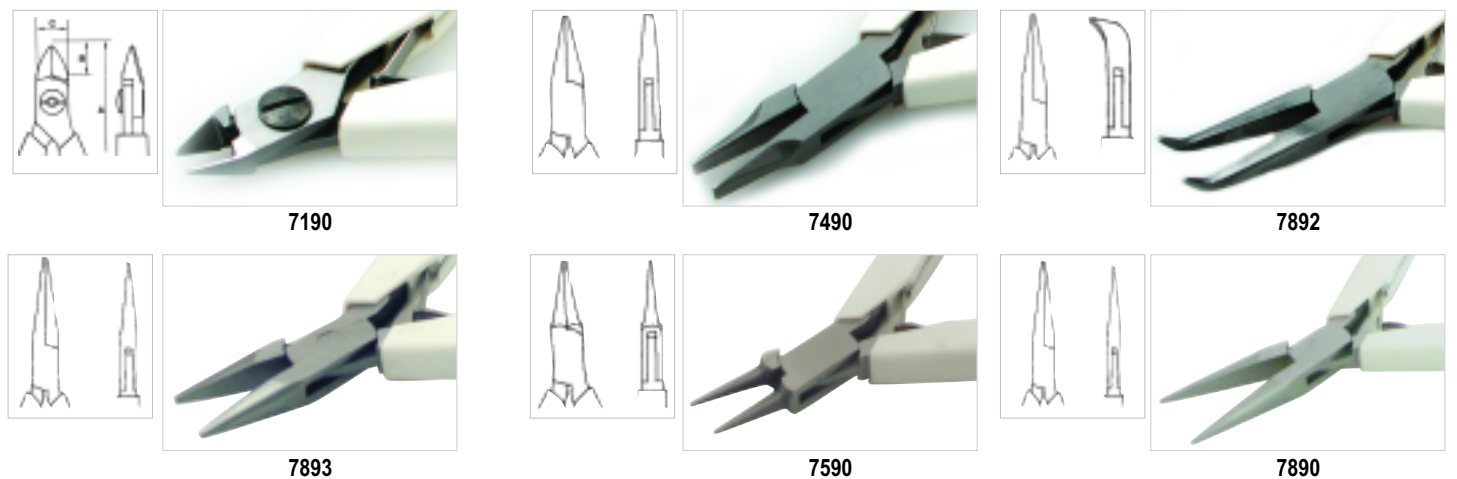

ITEM #	DESCRIPTION	STYLE	TYPE	A	B	C
41-1071	CUTTER- TAPERED	7190	MICRO BEVEL	4 ¹ / ₈ "/110MM	3 ³ / ₈ "/10MM	3 ³ / ₈ "/10MM
41-1072	FLAT NOSE	7490	SMOOTH	4 ¹ / ₈ "/110MM	3 ³ / ₈ "/10MM	3 ³ / ₈ "/10MM
41-1073	SHORT NOSE	7893	SMOOTH	4 ³ / ₄ "/110MM	3 ³ / ₄ "/20MM	3 ³ / ₈ "/10MM
41-1074	ROUND NOSE	7590	VERY FINE	4 ³ / ₄ "/110MM	3 ³ / ₄ "/20MM	3 ³ / ₈ "/10MM
41-1075	CHAIN NOSE	7890	SMOOTH	4 ³ / ₄ "/110MM	3 ³ / ₄ "/20MM	3 ³ / ₈ "/10MM
41-1076	BENT NOSE	7892	SMOOTH	5 ¹ / ₄ "/130MM	1 ¹ / ₈ "/28MM	3 ³ / ₈ "/10MM

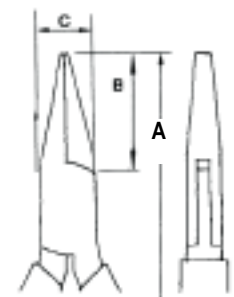



9. Lindstrom® Bio-Spring Pliers Rx Series - Sweden

A new concept in pliers, the bio-spring system adjusts to give the correct feel when crafting jewelry. Precision box joint, super smooth pivot movement, combined with an ergonomic handle design makes it the best plier for professional jewelers.



RX7590



RX7892



RX7490



RX7890



RX7893

A: OVERALL LENGTH

B: JAW LENGTH

C: JAW WIDTH



ITEM #	DESCRIPTION	STYLE	A	B	C
41-1081	ROUND NOSE	RX7590	5 ³ / ₄ "/146.5MM	3 ¹ / ₄ "/20MM	3 ³ / ₈ "/10MM
41-1082	FLAT NOSE	RX7490	5 ³ / ₄ "/146.5MM	3 ¹ / ₄ "/20MM	3 ³ / ₈ "/10MM
41-1083	CHAIN NOSE	RX7893	5 ¹ / ₄ "/132MM	3 ¹ / ₄ "/32MM	3 ³ / ₈ "/10MM
41-1084	CHAIN BENT NOSE	RX7892	6 ¹ / ₈ "/155.5MM	1 ¹ / ₈ "/28MM	3 ³ / ₈ "/10MM
41-1085	CHAIN NOSE LONG	RX7890	6 ¹ / ₄ "/158.5MM	1 ¹ / ₄ "/28MM	3 ³ / ₈ "/10MM

10. Stainless Steel Pliers with Rubber Grip- Japan

Quality and dependability you can count on. Handy small size for intricate work. Available in different color handles for easy identification.



ITEM #	DESCRIPTION
41-1091	HALF ROUND 135MM BLUE
41-1092	HALF ROUND/FLAT 135MM ORANGE
41-1093	ROUND 135MM YELLOW
41-1095	HALF ROUND 160MM BLUE
41-1096	HALF ROUND/FLAT 160MM ORANGE

11. Superlight Pliers- Germany 4¹/₂" (115MM)

Made of good quality steel with forged handles for a comfortable grip. Designed for delicate work, these precision pliers have box joints to ensure perfect alignment. All pliers have double leaf springs. Use for forming and shaping thin gauge wire and metal sheet.

Chain Nose - 4¹/₂"



ITEM #	DESCRIPTION
41-1111	CHAIN NOSE

Round Nose - 4¹/₂"



ITEM #	DESCRIPTION
41-1112	ROUND NOSE

Flat Nose - 4¹/₂"



ITEM #	DESCRIPTION
41-1113	FLAT NOSE

Side Cutter - 4¹/₂"



ITEM #	DESCRIPTION
41-1114	SIDE CUTTER



PLIERS & SHEARS

12. Y2K Series Pliers & Cutters -Germany 4 1/2" (115MM)

These box joint, double leaf spring pliers are precision finished to assist working in special applications. Pivots are close fitting to ensure accurate nose alignment. Several different combinations of nose shapes allow the user to form metal in custom designs.



Round Nose



ITEM #	DESCRIPTION
41-1122	ROUND NOSE - 4 1/2"/115MM

Side Cutter



ITEM #	DESCRIPTION
41-1124	SIDE CUTTER- 4 1/2"/115MM

End Side Cutter



ITEM #	DESCRIPTION
41-1126	END SIDE CUTTER- 4 1/2"/115MM

Round / Flat Nose



ITEM #	DESCRIPTION
41-1128	ROUND/FLAT- 4 1/2"/115MM

Chain Nose



ITEM #	DESCRIPTION
41-1121	CHAIN NOSE - 4 1/2"/115MM

Flat Nose



ITEM #	DESCRIPTION
41-1123	FLAT NOSE- 4 1/2"/115MM

Bent Chain Nose



ITEM #	DESCRIPTION
41-1125	BENT CHAIN NOSE- 4 1/2"/115MM

Oblique Cutter



ITEM #	DESCRIPTION
41-1127	OBLIQUE CUTTER- 4 1/2"/115MM

Half-Round / Flat



ITEM #	DESCRIPTION
41-1129	HALF-ROUND / FLAT- 4 1/2"/115MM



13. Slim-Line Pliers- Germany 4½" (115MM)

Slender box joint pliers, made of the finest steel, all with double leaf springs. Features close fitting joints and PVC coated handles for precision and durability. Preferred for use in all types of bench work.

Chain Nose	Round Nose	Flat Nose	Semi Flush Cutter
ITEM # DESCRIPTION	ITEM # DESCRIPTION	ITEM # DESCRIPTION	ITEM # DESCRIPTION
41-1131 CHAIN NOSE	41-1132 ROUND NOSE	41-1133 FLAT NOSE	41-1134 SEMI FLUSH CUTTER

Bent Chain Nose	End Cutter	Oblique Cutter	Side Cutter Flush
ITEM # DESCRIPTION	ITEM # DESCRIPTION	ITEM # DESCRIPTION	ITEM # DESCRIPTION
41-1135 BENT CHAIN NOSE	41-1136 END CUTTER	41-1137 OBLIQUE CUTTER	41-1138 SIDE CUTTER FLUSH

14. Special Pliers- Germany 4½" (115MM)

Prong Opening Plier

Open prongs without fracturing stones. The upper angled jaw has a claw and the lower jaw a groove. The prong is supported at the base to avoid pressure on the top of the stone. Features box joint, double leaf springs and a cushion grip.



ITEM #	DESCRIPTION
41-1141	PRONG OPENING PLIER

Prong Closing Plier

Single squeeze action closes opposite prongs over stones. Bent jaws with grooved ends securely hold prongs. Features perfectly aligned jaws, double leaf springs and a cushion grip.



ITEM #	DESCRIPTION
41-1142	PRONG CLOSING PLIER



PLIERS & SHEARS

15. Regular Pliers-Germany 5"

Superior quality pliers with precision fit and accurate alignment. Specially shaped nose forms, smooth and polished finish, all fitted with double leaf spring. Handles are red PVC dipped for a comfortable non-slip grip. Very useful for all types of bench work.

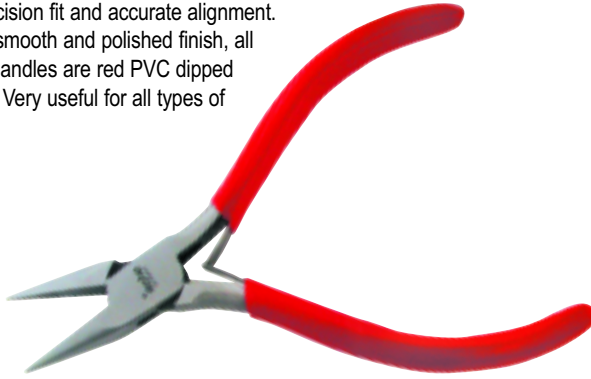

Chain Nose



ITEM #	DESCRIPTION
41-1151	C/NOSE SERRATED
41-1152	CHAIN NOSE

Round Nose



ITEM #	DESCRIPTION
41-1153	ROUND NOSE

Side Cutter Flush



ITEM #	DESCRIPTION
41-1154	SIDE CUTTER

Flat Nose



ITEM #	DESCRIPTION
41-1155	FLAT NOSE
41-1156	F/NOSE SERRATED

Bent Chain Nose



ITEM #	DESCRIPTION
41-1157	BENT CHAIN NOSE

End Cutter



ITEM #	DESCRIPTION
41-1158	END CUTTER

Semi Flush Cutter



ITEM #	DESCRIPTION
41-1159	S/FLUSH CUTTER

16. Nylon Pliers- 5 1/2"/140mm

Flat Nose



ITEM #	DESCRIPTION
41-1161	TWO NYLON JAWS
41-1162	NYLON JAWS ONLY

Flat / Round Nose



ITEM #	DESCRIPTION
41-1163	ONE NYLON JAW
41-1164	NYLON JAW ONLY

52. Half-Round / Flat



ITEM #	DESCRIPTION
41-1165	ONE NYLON JAW
41-1166	NYLON JAW ONLY

PLIERS & SHEARS



17. Lap Joint Pliers- Germany 4½" (115MM)

Well crafted pliers in various nose shapes, all with lap joints and PVC coated handles. A perfect selection for the beginner in fabrication, repairing and bench work.



Set consists of one each - chain nose, round nose, flat nose and side cutter

ITEM #	DESCRIPTION
41-1171	4 PCS SET

Chain Nose



ITEM #	DESCRIPTION
41-1172	CHAIN NOSE

Round Nose



ITEM #	DESCRIPTION
41-1173	ROUND NOSE

Flat Nose



ITEM #	DESCRIPTION
41-1174	FLAT NOSE

Side Cutter



ITEM #	DESCRIPTION
41-1175	SIDE CUTTER

18. Shape Forming Pliers

Half-Round / Hollow Nose



Jaws are concave and convex, ideal for use when forming shallow curves in ring finishing.

ITEM #	DESCRIPTION
41-1181	GERMAN 5"/130MM
41-1191	VALUE 5"/130MM

Half-Round / Flat Nose



A semi-circular and flat jaw to hold delicate parts with a firm grip, useful while stretching.

ITEM #	DESCRIPTION
41-1182	GERMAN 5"/130MM
41-1192	VALUE 5"/130MM

Round / Flat Nose



Smooth jaw, precisely aligned to bend or hold rings while crafting and fabricating.

ITEM #	DESCRIPTION
41-1183	GERMAN 5"/130MM
41-1193	VALUE 5"/130MM

Round Nose / Hollow

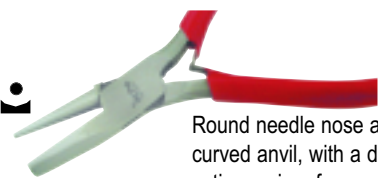

Round needle nose and curved anvil, with a double action spring, for special applications.

ITEM #	DESCRIPTION
41-1184	GERMAN 5½"/140MM
41-1194	VALUE 5½"/140MM

Chain Nose - Long

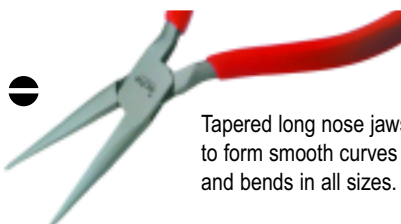

Tapered long nose jaws, to form smooth curves and bends in all sizes.

ITEM #	DESCRIPTION
41-1185	LONG NOSE 5½"/140MM

Flat Nose - Long

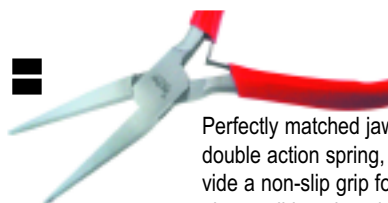

Perfectly matched jaws, double action spring, provide a non-slip grip for almost all bench tasks.

ITEM #	DESCRIPTION
41-1186	FLAT NOSE 5½"/140MM



19. Pliers & Cutters - Value 115MM

Well crafted pliers in various nose shapes, all with box joints, double leaf springs and PVC coated handles. A perfect selection for the beginner in fabrication, repairing and bench work.

Set consists of one each - chain nose, round nose, flat nose and side cutter

ITEM #	DESCRIPTION
41-1201	SET OF 4 PCS

Chain Nose

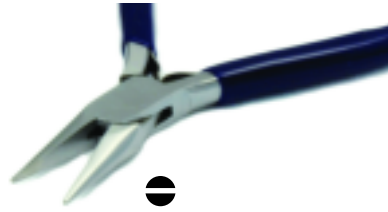

ITEM #	DESCRIPTION
41-1202	CHAIN NOSE

Round Nose



ITEM #	DESCRIPTION
41-1203	ROUND NOSE

Flat Nose



ITEM #	DESCRIPTION
41-1204	FLAT NOSE

Side Cutter



ITEM #	DESCRIPTION
41-1205	SIDE CUTTER

Bent Nose



ITEM #	DESCRIPTION
41-1206	BENT NOSE

20. Pliers & Cutters

Light Weight Value 115MM

Well crafted pliers in various nose shapes, all with box joints, double leaf springs and PVC coated handles. A perfect selection for the beginner in fabrication, repairing and bench work.

Set consists of one each - chain nose, round nose, flat nose and end cutter

ITEM #	DESCRIPTION
41-1211	SET OF 4 PCS

Chain Nose



ITEM #	DESCRIPTION
41-1212	CHAIN NOSE

Flat Nose



ITEM #	DESCRIPTION
41-1213	FLAT NOSE

Round Nose



ITEM #	DESCRIPTION
41-1214	ROUND NOSE

End Cutter



ITEM #	DESCRIPTION
41-1215	END CUTTER

Bent Nose



ITEM #	DESCRIPTION
41-1216	BENT NOSE



21. Pliers & Cutters

Brass Line Flat Plier



Soft metal jaws that will not nick or mar. Essential when working with thin sheet gauge metal.

ITEM #	DESCRIPTION
41-1221	BRASS LINE

Ring Bending Pliers



Smooth jaw, precisely aligned to bend or hold rings while crafting and fabricating.

ITEM #	DESCRIPTION
41-1222	5" GERMAN
41-1223	6" GERMAN

Ring Holding Plier



Made of forged polished steel, with lap joints and large grooved jaws, these pliers are indispensable for holding rings while working on the insides.

ITEM #	DESCRIPTION
41-1224	GERMAN
41-1234	VALUE

Loop Closing Plier



Hollow, polished jaws, box joints and longer handles provide effortless closing of rings and other oval forms.

ITEM #	DESCRIPTION
41-1225	LOOP CLOSING PLIER

Bow Closing Plier



Designed with a V-groove lower jaw and a curved upper jaw with close fitting box joints. These pliers are used to form shapes.

ITEM #	DESCRIPTION
41-1226	GERMAN
41-1236	VALUE

Rosary Plier with Cutter



This combination quality tool works both as a round nose plier and a side cutter. Made in hardened steel, with a double spring action, it reduces fatigue and increases production.

ITEM #	DESCRIPTION
41-1227	ROSARY PLIER

Stone Setting Plier



Quality tool steel box joint pliers with double leaf spring and PVC dipped handles. Grooved jaw locates prong accurately to secure the stone.

ITEM #	DESCRIPTION
41-1241	GERMAN
41-1251	VALUE

Notching Plier Strap/Solder



Ideal tool for cutting uniform pieces of solder. May be use notching watch straps. Steel construction, lapped joints for easy notching.

ITEM #	DESCRIPTION
41-1252	NOTCHING PLIER
	5"-115MM

Prong Lifting Pliers



Special pliers, lap joint, double leaf spring, provides gentle pressure on the prong and no pressure on the stone to avoid mar or fracture.

ITEM #	DESCRIPTION
41-1245	PRONG LIFTING PLIER- 5"

22. Straight & Oblique Cutter-Swiss

Medium capacity with spring jaws and lock. Use for cutting sprues of up to 3 mm. Overall length 6 1/2", with smooth plastic grip handles.



ITEM #	DESCRIPTION
41-1243	OBLIQUE 67
41-1244	STRAIGHT 67B



PLIERS & SHEARS

23. Pastorino Sprue Cutter

Italian made 9 1/2" sprue cutter has chrome vanadium steel blades with a locking device. Special shaped hand grips provide effortless cutting in small areas.



ITEM #	DESCRIPTION
41-1311	SPRUE CUTTER

27. Compound Sprue Cutter

Heavy duty diagonal cutter with compound leverage for cutting sprues with minimal effort. Overall length is 7 1/2", and cutting capacity is 3mm.



ITEM #	DESCRIPTION
41-1312	COMPOUND CUTTER-GERMAN

BERGEON 24. Bergeon Sprue Cutter- 6599

Top quality Swiss cutter, with a multiple linkage system, that gives maximum pressure with minimum fatigue. Extra long handles and special shaped jaws allow access to small areas.



ITEM #	DESCRIPTION
41-1313	SPRUE CUTTER
41-1314	REPLACEMENT JAW
41-1315	SPRING

28. Swiss Sprue Cutter -18055

Made of premium tool steel, these heavy duty cutters have hardened jaws, precision compound joints and extra long handles to provide leverage. Features angled jaws that align to facilitate the close cutting of sprues.



ITEM #	DESCRIPTION
41-1317	SWISS SPRUE CUTTER

BERGEON 25. Bergeon Bracelet Cutter

One of the finest heavy duty cutters with a unique compound linkage system to make repeated cuts with less effort. Very good overall fit and finish, hardened cutting edges, with a built-in jaw setting screw. Provides blade protection and increases cutting capability.

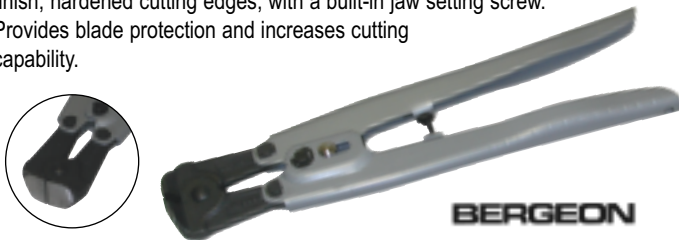

ITEM #	DESCRIPTION
41-1318	BRACELET CUTTER-6496



29. Keiba Cutter with Lock- Japan

An elegantly designed cutter, with polished hardened cutting edge and compound action jaws. Fine setting screw guarantees a clean cut and protects the blade from damage.



ITEM #	DESCRIPTION
41-1319	KEIBA CUTTER WITH HANDLE



30. Keiba Cutter- Japan

Cuts sprues up to 3mm with ease, accuracy and repeatability. Compound joint construction, fine finished sharp jaws nip off metal with a flush cut.



ITEM #	DESCRIPTION
41-1322	REGULAR CUTTER
41-1323	FLUSH CUT

26. Maun Type Cutter

Medium capacity with spring jaws and lock. Use for cutting sprues up to 3 mm. Overall length 6 1/2", with smooth plastic grip handles.



ITEM #	DESCRIPTION
41-1321	MAUN TYPE CUTTER WITH SPRING



31. Parallel Pliers- Maun

Parallel action pliers provide vise-like grip. Handles are anti-rust nickel plated. Jaws remain parallel when in use. Made in England.

ITEM #	DESCRIPTION	SIZE
41-1331	CHAIN NOSE	5"
41-1332	FLAT JAW	5"
41-1333	FLAT JAW- SERRATED	5"
41-1334	DIAGONAL CUTTER	5½"

32. Marking Plier- Germany

Durable stainless steel ring marking plier to stamp the inside of rings as well as other round and flat surfaces. Plier has adjustable screw to lock different stamps. Overall length 5½".



ITEM #	DESCRIPTION
41-1341	MARKING PLIER ONLY
51-1342	MARKING PLIER BOX ONLY
51-1343	FLAT & CURVED ANVIL
41-1344	PLIER WITH 3 STAMPS (10, 14, 18K)

*Individual stamps are sold separately.
See page # 278*

33. Pneumatic Sprue Cutter

Eliminate manual cutting by using this foot operated, air powered bench sprue cutter. Needs an external air compressor at 60-80 PSI. Miniature blades access closely spaced sprues. May be hand operated when not on the stand.



Complete set includes:
Sprue cutter, point blade-S7P, stand, foot pedal and air hose with connections.

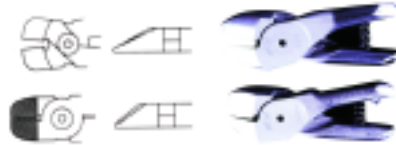

ITEM #	DESCRIPTION
41-1351	SPRUE CUTTER COMPLETE SET
41-1352	SPRUE CUTTER ONLY
41-1353	STAND FOR SPRUE CUTTER
41-1354	FOOT PEDAL FOR SPRUE CUTTER
41-1355	REPLACEMENT BLUNT CARBIDE BLADE Z8P
41-1356	REPLACEMENT POINT BLADE S7P
41-1357	REPLACEMENT HOSE GREEN

34. Plier Organizers

Plier Holding Rack: An attractive hardwood, polished stand, with pairs of holes. Lets you keep your pliers handy and easily visible on your work bench. Upright storage eliminates damage to the jaw ends.

Wooden Plier Rack: Improve your efficiency by increasing work bench space with the addition of this shelf and drawer space saver. Convenient to store small tools, parts and work articles.

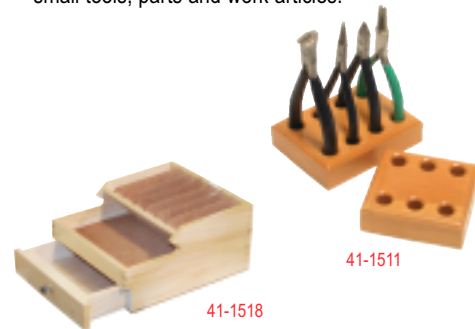

ITEM #	DESCRIPTION
41-1511	6 HOLES- 3 PLIER HOLDER
41-1512	8 HOLES- 4 PLIER HOLDER
41-1513	10 HOLES- 5 PLIER HOLDER
41-1514	12 HOLES- 6 PLIER HOLDER
41-1515	16 HOLES- 8 PLIER HOLDER
41-1516	20 HOLES- 10 PLIER HOLDER
41-1517	RACK WITH DRAWER



35. Shears -Germany

Made of ground and polished steel, with PVC coated handles, these light duty shears with fine tips are very practical for cutting thin gauge metal. Two blade shapes are available, straight and curved. The curved blade is very useful for cutting smooth contours and circles. Overall length 7".

ITEM #	DESCRIPTION
41-2161	STRAIGHT - WITH SPRING
41-2162	CURVED - WITH SPRING
41-2163	STRAIGHT - WITHOUT SPRING
41-2165	CURVED - WITHOUT SPRING



41-2161

41-2162



41-2163

36. Shears without Spring

Very efficient light duty shears for cutting patterns in thin gauge metal. Perfect for snips and corner cuts.

ITEM #	DESCRIPTION
41-2173	STRAIGHT - WITHOUT SPRING
41-2174	CURVED - WITHOUT SPRING



41-2174

37. Shears with Leaf Spring- Solingen

Shears with leaf spring and locking system, increases flexibility in cutting chains, solder and thin sheets. Overall length 7".

ITEM #	DESCRIPTION
41-2181	STRAIGHT- SHEAR WITH LEAF SPRING



41-2181

38. Wire Bending Plier

An ingenious bending plier to create all types of round, undulating, serpentine or special forms in wire or thin gauge metal. Fine screw adjustment provides a convenient stop and assures consistent shaped forms.



41-2184

ITEM #	DESCRIPTION
41-2184	WIRE BENDING PLIERS

39. Sheet Shear - German

Made of drop forged steel, heat treated and tempered. Large loop handles, plastic coated for comfort. Ideal for cutting sheet metal. Blade length 1 1/2". Overall length 7 1/2".



41-2186

ITEM #	DESCRIPTION
41-2186	SHEET METAL SHEAR

PLIERS & SHEARS



40. Brown Type Shears

Heavy duty construction, use for making straight cuts. Available for right and left hand operation. Overall length 8" with 1 1/2" cutting length.



ITEM #	DESCRIPTION
41-2191	SHEAR - RIGHT HAND
41-2192	SHEAR - LEFT HAND

42. Portable Ring Shear

Easy ring sizing by shearing the exact width that needs to be removed from the ring shank. Install the correct size of cutter. Place the ring on die and shear with a down stroke. Save the cut piece for future use.



41-1412

ITEM #	DESCRIPTION
41-1412	RING SHEAR
41-1414	SET OF CUTTERS 5 PCS (1-5MM)
41-1415	REPLACEMENT CUTTER 1MM
41-1416	REPLACEMENT CUTTER 2MM
41-1417	REPLACEMENT CUTTER 3MM
41-1418	REPLACEMENT CUTTER 4MM
41-1419	REPLACEMENT CUTTER 5MM

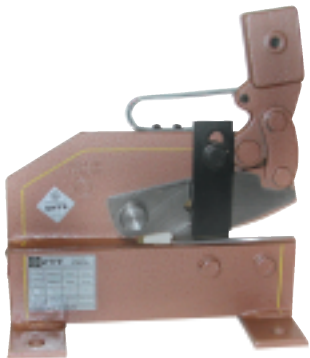

41. Shears Scissor Type

Heavy duty diagonal cutter with compound leverage for cutting sprues with minimal effort. Overall length is 7 1/2", and cutting capacity is 3mm.



ITEM #	DESCRIPTION
41-2194	SHEAR- STRAIGHT
41-2196	SHEAR- CURVED

43. Universal Shears with Spring

Easily cuts intricate in and out designs from sheet metal. Blade length 1 3/4". Overall length 7 1/2".



ITEM #	DESCRIPTION
41-2198	UNIVERSAL SHEARS

44. GRS Ring Size Cutter

USA Model: Includes 7 cutters from USA / British size 1/2 to 2 in 1/4 increments.

Metric Model: Includes 9 cutters from 1mm-5mm, in 0.5mm increments.



ITEM #	DESCRIPTION
41-2221	#004-642 USA MODEL
41-2222	#004-643 METRIC MODEL
41-2224	#004-585 USA / BRITISH KITS
41-2225	#004-643 METRIC KITS

45. Bench Shears with Handle

Used for cutting gold, silver, copper, brass and any other metals. The long handle provides leverage for easy cutting. Comes in three sizes.

ITEM #	STYLE	FLAT BAR	ROD	SHEET	BLADE LGTH.
41-2201	4R	2 3/8" X 5/32"	3/8"	1/8" (10 GA)	4 3/4"
41-2203	5R	2 3/8" X 3/16"	7/16"	5/32" (8 GA)	6 1/4"
41-2205	6R	2 3/4" X 1/4"	1/2"	3/16" (6 GA)	8"

Replacement blades may be ordered separately.



POLISHING

■ 3M® Vetrap™ Tapes	227
■ 3M® Scotch Brite Cloths	226
■ Arbors	227
■ Chamois Cloths -Super Fine	226
■ Dialux Polishing Compounds	224
■ Double End Polisher 1/2 HP & 3/4 HP	228
■ Double End Polisher-1/4 HP	229
■ Double Shaft Polisher / Dust Collector	227
■ Dust Collector Hood and Accessories	229
■ Finger Guard Safety Tape	227
■ Handler Polishing / Dust Collector	229
■ Ikohe Gold Collector	225
■ Initial Polishing Compounds	227
■ Inspection Cotton Gloves	224
■ Koyo Premium Platinum Rouge	226
■ Lint Free Cloths for Precious Stones	229
■ Matt® Gold Collector	225
■ Menzerna® Rouge	228
■ Mini Bench Grinder/Polisher	228
■ Mini Bench Polishing Lathe	224
■ Pica Platinum Rouge - Japan	224
■ Platinum Rouge- Japan	230
■ Quatro® Polisher / Dust Collector	230
■ Quatro® Jet Stream- Clean Air	230
■ Quatro® Dust Collectors	226
■ Rouge Cloth	



■ Rouge Polishing Compounds	225
■ Rubber Finger Cots	226
■ Satiner Compound	226
■ Selvyt® Cloth-Impregnated	226
■ Selvyt® Cloths	227
■ Simichrome Polishing Paste	228
■ Single End Polisher 1/2 HP & 3/4 HP	229
■ Single Spindle Polisher/Dust Collector	225
■ Soft Polishing Compounds	228
■ Split Lapping Machine	

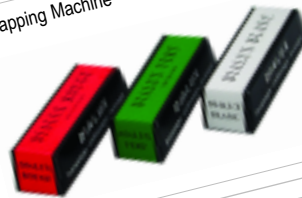

Jewelry: Concepts and Technology

by **Oppi Untracht**

The most thorough reference book available on traditional and innovative jewelry-making techniques. Features contemporary works from over 300 jewelers. 900 photos, 377 illustrations, step-by-step instructions, comprehensive glossary and a detailed index. A must-have book.

61-1016 (Hardcover – 840 pages)

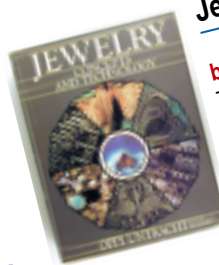



KOYO 1. Premium Platinum Rouge- Japan

A finishing compound, manufactured from carefully graded abrasive, blended with additives to give high reflective surfaces to precious metals, alloys and stainless steel. Priced by bar. Dimensions: 40 X 60 X 20mm.

Green Rouge G-800:	General purpose cutting compound to eliminate scratches.	42-1011	80G*
Green Rouge K 1:	Cut and color compound for all precious metals.	42-1014	80G*
Green Rouge K 2:	Formulated specially for pre-polish of gold and silver.	42-1016	80G*
Alox Cut 1:	Fast cutting compound for precious metals including platinum.	42-1021	80G*
Alox Cut 2:	Suitable as a cutting compound for gold and silver.	42-1022	80G*
Alox Cut 3:	Intermediate pre-polish to prepare for final finishing.	42-1023	80G*
Alox-5 White:	Imparts an ultra shine with a distinctive luster - Small	42-1025	80G*
	Large	42-1026	320G*
Super Alox Gold:	A premium compound to provide a high luster on gold.	42-1027	150G*
Super Alox Silver:	Imparts an excellent reflective surface on silver.	42-1028	150G*

* Weights are approximate. See note below. Refer page #68 for use of KOYO Polishing Compounds

2. Platinum Rouge- Japan

A selected grade of polishing compound formulated for ultra bright finishing of platinum. Uniformly blended and manufactured under strict quality control. Exceptional adherence to buffs, brushes or felts. Different grades to achieve surfaces from matte to super shine. Priced by bar.

Gray N-500 :	Fast cutting compound to smooth the surface after casting.	42-1031	350G*
Gray NW-800 :	Soft cutting compound to improve the surface.	42-1032	420G*
White NW-1500 :	Medium cutting compound prior to pre-polish.	42-1033	80G*
White NW-4000 :	A finer cutting compound to remove hair line scratch marks.	42-1034	400G*
White NW-6000 :	A pre-polish for final finishing of platinum and titanium	42-1035	340G*
White NW-8000 :	Elevates the surface to an ultra shine.	42-1036	450G*

* Weights are approximate. See note below

3. Pica Platinum Rouge - Japan

The only compound for unsurpassed finish on platinum. Priced by bar.

Pica Blue :	A premium compound to provide a high luster on platinum.	42-1041	350G*
Pica-Ace Pink :	Imparts an excellent reflective surface on platinum and titanium.	42-1042	350G*

*Weights are approximate. See note below

4. Dialux Polishing Compounds

A select type of super soft abrasive, uniformly blended with a carrier wax. These compounds have a special formulation for good adhesion to buffs or felt wheels. Only minimal amounts need to be used. Bar size 4" x 1 1/4" x 1/8". Priced by bar.

Red Dialux:	For a bright shine on yellow gold and silver.	42-1051	4 OZ.
Green Dialux:	Medium cutting compound for chrome and stainless steel.	42-1052	4 OZ.
White Dialux:	For reflective polishing of silver and silver alloys.	42-1053	4 OZ.
Blue Dialux:	A general purpose polishing compound for all metals.	42-1054	4 OZ.
Orange Dialux:	Leaves a high degree of finish on soft metals.	42-1055	4 OZ.
Yellow Dialux:	Recommended for a bright finish on brass, bronze and copper.	42-1056	4 OZ.
Gray Dialux:	Best for producing a reflective finish on stainless steel.	42-1057	4 OZ.

NOTE: All polishing compounds have different agents blended together with a binder. Therefore, the densities being different, the weights vary accordingly.





5. Menzerna® Rouge

A unique type of rouge formulated with a blend of soft abrasive and a bonding agent. Generates a balanced cutting action and extends well, so that just a small amount of compound is needed. Priced by bar.

	(100G)	(200G)
Carrot PT. Rouge: Imparts a high quality surface finish on platinum.	42-1066	42-1076

*Weights are approximate.



6. Initial Polishing Compounds

These compounds are used for the initial preparation of metal surfaces. Sold by weight.

Bobbing Compounds : An aggressive compound that smoothes gold, silver and non-ferrous alloys	42-1081	1 LB*
Bown Tripoli : An intermediate compound that reduces scratch or filing marks.	42-1082	1 LB*
4X White Diamond : A soft cutting compound that is less aggressive and is preferred for gold and silver	42-1083	1 LB*
Gray Star : An excellent polishing compound that leaves a soft bright pre-finish on platinum and palladium	42-1084	1 LB*

*Weights are approximate.



7. Rouge Polishing Compounds

Rouge polishing is the ultimate step to achieve maximum luster. A superfine polishing compound for use on muslin or chamois wheels. Has an extremely light cutting action. **Sold by /lb.**

Red Rouge: High luster, final polish for gold, silver and other soft non-ferrous metals.	42-1091	1 LB*
	42-1092	½ LB*
	42-1093	¼ LB*
Green Rouge: A rouge polishing compound for stainless steel, white gold and palladium.	42-1097	1 LB*
	42-1098	½ LB*
	42-1099	¼ LB*
Black Rouge: A very effective rouge compound for silver and silver alloys.	42-1105	¼ LB*
Yellow Rouge: A special rouge polishing compound for chrome, stainless steel, white gold and platinum.	42-1107	1 LB*
	42-1108	¼ LB*
White Rouge: Recommended as the best polishing rouge for an ultra shine on niobium and titanium.	42-1110	¼ LB*

*Weights are approximate.



8. Soft Polishing Compounds

These compounds enhance the surface of materials from a dull satin to a medium bright finish. The surface of the metal and alloys improves appreciably, as fine hair line scratches are virtually non-existent. **Sold by /lb.**

Zam®: A crocus compound that produces scratch free surfaces on all precious metals. May also be used for polishing soft semi-precious stones.	42-1114	1 LB*
Fabuluster®: A polishing compound formulated for working on plastic, fiberglass or soft metals. Use for final buffing.	42-1118	1 LB*
Ikohe® Luster: Produces a high luster on metals and plastic. Sold in peel away tube container	42-1120	1 LB*

*Weights are approximate.





9. Satiner - Compound for Satin Finish

Achieve a satin finish by buffing. Use this greaseless compound that combines a blend of fine abrasive in a water soluble bond. Apply across the face of a loose cloth buff. Allow the buff to spin for about 50 secs. until the satiner hardens. Polish the article for a satin finish.



ITEM #	DESCRIPTION
42-1121	SATINER 1 LB 220 GRIT

10. Selvyt® Cloths

High quality, long lasting, lint free cloth. Treat it with a little polishing rouge then use it to shine jewelry, watches, silverware and crystal.

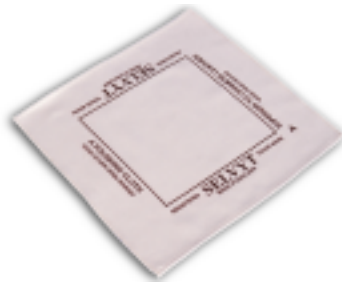

ITEM #	DESCRIPTION	SIZE
42-1141	SELVYT CLOTH	5" X 5"
42-1142	SELVYT CLOTH	10" X 10"
42-1143	SELVYT CLOTH	14" X 14"
42-1144	SELVYT CLOTH	14" X 17"
42-1145	SELVYT CLOTH	17" X 21"
42-1146	SELVYT CLOTH	20" X 21"

11. Selvyt Cloth Impregnated

Soft, lint-free, velvet like impregnated cloth. Treated with a polishing agent that imparts a long lasting shine on precious metals.



ITEM #	DESCRIPTION	SIZE
42-1161	SELVYT CLOTH	10" X 10"

12. Lint Free Cloths for Precious Stones

Non-abrasive lint free cleaning cloths restore luster and brilliance to jewelry and precious stones. Scratch proof cleaning action is gentle.
White: Stones & Pearls **Blue:** Diamond

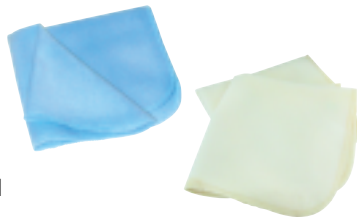

ITEM #	DESCRIPTION	SIZE
42-1166	WHITE- PEARL	9" X 11"
42-1167	BLUE - DIAMOND	9" X 11"

13. Rubber Finger Cots

Superior quality rubber, provides a comfortable grip and protects finger tips during grinding and polishing.
Sold bx/ dz.



ITEM #	STYLE	SIZE
45-1191	11	SMALL
45-1192	12	MEDIUM
45-1193	13	LARGE
45-1194	14	EX- LARGE

14. 3M® Scotch Brite Cloths

A safe and effective cloth that lifts out liquids, grease and grime. Very durable wipes that can be machine washed in cold water, then air dried.



ITEM #	SIZE	COLOR
42-1151	12½" X 14½"	WHITE
42-1152	12½" X 14½"	BLUE
42-1153	12½" X 14½"	GREEN
42-1154	12½" X 14½"	YELLOW
42-1155	12½" X 14½"	RED

15. Chamois Cloths -Super Fine

Long lasting chamois imparts an excellent shine to jewelry and a brilliance to precious stones.



ITEM #	SIZE	COLOR
42-1164	10" X 10"	BEIGE

16. Rouge Cloth

A short nap cloth impregnated with rouge, feels like felt and removes tarnish and fine scratch marks.

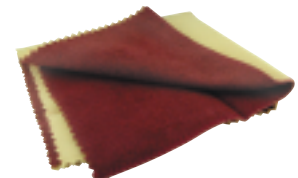

ITEM #	SIZE	COLOR
42-1169	9" X 11"	BROWN



17. Finger Guard Safety Tape

An alternative to finger guards, protection tape readily adheres and is easy to apply and remove. Made of surgical grade gauze, it conforms to the contours of the finger. Ideal protection from the hazards of sharp edges and hot surfaces.

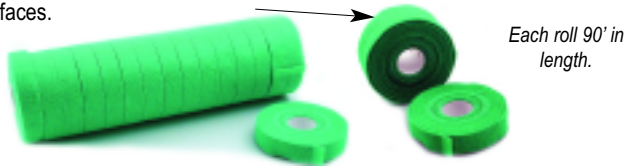

ITEM #	DESCRIPTION
45-1041	SAFETY TAPE- GREEN 3/4" X 90' - PK/16
45-1042	SAFETY TAPE- GREEN 1" X 90' - PK/12

18. Inspection Cotton Gloves

An absolute necessity that is needed when handling precious metal and stones. Made of special cotton fabric, it is invaluable while inspecting jewelry. Sold bx/dz.



ITEM #	DESCRIPTION
45-1095	GENTS- LARGE
45-1096	LADIES- SMALL

19. Simichrome Polish

A polishing paste for a high luster on gold, silver, copper, chrome and other metals. Excellent for polishing antiques. Apply with a lint free cloth and rub off to obtain a shine. Small amounts may be used to charge dry cob media for tumbling.



ITEM #	DESCRIPTION
42-1171	TUBE - 1.7 OZ / 50 GRAM

20. Dust Collector Hood and Accessories

Fiberglass protection hood complete with light socket and cord. Built-in suction inlet needs to be connected to an external dust collector.



ITEM #	DESCRIPTION
42-1311	DUST COLLECTOR HOOD 11" X 16" X 15"
42-1312	DUST COLLECTOR HOOD 6" X 11 1/2" X 10"
42-1316	FISHMOUTH*
42-1317	LIGHT SOCKET WITH CORD
42-1321	HOOD SHIELD 9" X 6"
42-1324	WIRE MESH FOR HOOD
42-1325	3" HOSE*- PER FT.
42-1326	CLAMP* FOR 42-1325

* (PICTURE NOT SHOWN)

21. 3M® Vetrap™ Tapes

Natural rubber latex, light and durable, this new non-adhesive wrap sticks to itself, but not to the skin. Protects fingers and wrists.



ITEM #	DESCRIPTION	W X L
45-1051	VETRAP WHITE	2" X 15'
45-1052	VETRAP PINK	2" X 15'
45-1053	VETRAP RED	2" X 15'
45-1054	VETRAP GREEN	2" X 15'
45-1055	VETRAP BLUE	2" X 15'

22. Arbors

- Use for mounting on motor shafts of polishing machines
- RH - Right Hand, LH- Left hand • "D" is diameter of the motor shaft

Tapered Spindle- for Baldor

- For Tapered Motor Shaft- brass

ITEM #	D Ø
42-1341	5/8" RH
42-1342	5/8" LH

Tapered Spindle

- For Straight Motor Shaft

ITEM #	D Ø
42-1344	1/2" RH
42-1345	1/2" LH
42-1346	5/8" RH
42-1347	5/8" LH

Arbor & Flange-Tapered

- For Straight Motor Shaft

ITEM #	D Ø
42-1351	1/2" RH
42-1352	1/2" LH
42-1353	5/8" RH
42-1354	5/8" LH

Arbor & Flange-Straight

- For Straight Motor Shaft

ITEM #	D Ø
42-1361	1/2" LH
42-1362	1/2" RH
42-1363	5/8" LH
42-1364	5/8" RH

Arbor with Chuck

- For Straight Motor Shaft
- Fitted with 1/4" capacity Jacobs chuck

ITEM #	D Ø
42-1371	1/2" RH



Tapered Chuck for Brushes
See page # 56



22. Single End Polisher 1/2 HP & 3/4 HP

Powerful, continuous duty motor with single 3/8" threaded shaft and tapered spindle. Hi-torque with rapid stop.



Wt. 41 lbs.
Single Speed : 3,450 RPM

220V available on order.

ITEM #	DESCRIPTION	SH.HT.
42-1211	1/2HP 110V/ 60HZ	7"
42-1213	3/4HP 110V/ 60HZ	7"

23. Double End Polisher

Totally enclosed, continuous rated motor, with pre-lubricated ball bearings. Straight shaft 1/2" diameter both ends. Supplied with right and left tapered spindles.



Wt. 41 lbs.
Single Speed : 3,450 RPM
Dual Speed: 3,450/1,725 RPM

220V available on order.

ITEM #	DESCRIPTION	SH.HT.
42-1221	1/4HP 110V/ 60HZ- DUAL SPEED	6"
42-1223	1/4HP 110V/ 60HZ- DUAL SPEED	4 1/2"
42-1225	1/4HP 110V/ 60HZ- SINGLE SPEED	6"

24. Double End Polisher 1/2 HP & 3/4 HP

Heavy duty motor, continuous rated for use in production shops. Right and left hand shaft extensions are straight 1/2" diameter. Supplied with two threaded tapered spindles.



Wt.42 lbs.
Single Speed : 3,450 RPM

220V available on order.

ITEM #	DESCRIPTION	SH.HT.
42-1231	1/2HP 110V/ 60HZ	6"
42-1233	3/4HP 110V/ 60HZ	6"

25. Mini Bench Grinder/Polisher

A versatile machine, ideal for small shops. Compact 1/8 HP motor. Variable speed from 1,500 to 4,000 rpm. May be used as a bench grinder, polisher, drill and carver. Unit includes flexshaft and handpiece. Dimensions. 8" X 6" X 7"
Wt. 10 lbs



ITEM #	DESCRIPTION	POWER
42-1241	110V/ 60HZ	1/8HP
42-1242	220V/ 50HZ	1/8HP

26. Split Lapping Machine

Floor Model An ideal machine for finishing flat or contoured surfaces. A sturdy machine mounted on a steel stand with a melamine laminated top. Heavy sheet steel hood with adjustable light. Provided with 3" ports for connection to a dust collector. Tapered spindle included. Ideal for 4", 5", 6", 7" and 8" felt split laps. Dimensions: 24" X 24" X 33"
Wt. 110 lbs



Split Laps
See page #58

Benchtop Model Similar to the above model but portable. Unit is complete with motor switch, grounded connecting cord and an adjustable work light. Dimensions: 15" X 18" X 20"
Wt. 46 lbs



This icon is intended to draw your attention to avoid breathing airborne dust particles

ITEM #	DESCRIPTION
42-1251	BENCH TYPE 1/2 HP/3450RPM 110V/ 60HZ
42-1252	BENCH TYPE 1/2 HP/3450RPM 220V/ 50HZ
42-1256	FLOOR TYPE 1/2 HP/3450RPM 110V/ 60HZ
42-1257	FLOOR TYPE 1/2 HP/3450RPM 220V/ 50HZ

27. Mini Bench Polishing Lathe

A lightweight polishing bench lathe with variable speed motor 500- 7000 rpm. Unit comes with right and left hand polishing spindles, dust collector hoods and work light. Dimensions. 10" X 5" X 7" Wt.7 lbs



ITEM #	DESCRIPTION
42-1245	110V/ 60HZ -1/8HP
42-1247	DUST COLLECTOR HOOD



28. Single Spindle Polisher/Dust Collector

A compact single end polisher with $\frac{5}{8}$ " tapered spindle. Includes a dust collector suction motor with replaceable filters.
 Speed: 3,450 rpm
 Maximum Wheel Ø : 6"
 Dimensions: 15" X 17" X 10"
 Wt. 46 lbs

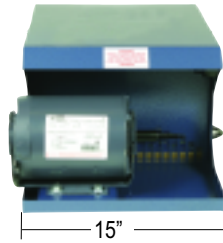

ITEM #	SPECIFICATIONS	POWER
42-1261	110V/ 60HZ	$\frac{1}{2}$ HP
42-1262	220V/ 50HZ	$\frac{1}{2}$ HP
42-1265	REPLACEMENT FILTER	

29. Double Shaft Polisher / Dust Collector

Heavy duty, medium sized double end polisher. Tapered spindles $\frac{5}{8}$ " at both ends. Unit includes dust collector suction motor with replaceable filters.
 Speed: 3,450 rpm
 Maximum Wheel Ø : 6"
 Dimensions: 24" X 16 $\frac{1}{2}$ " X 12"
 Wt. 52 lbs

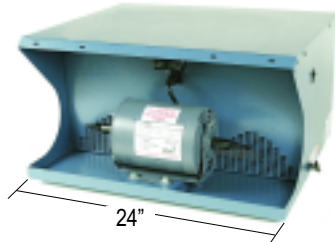

ITEM #	SPECIFICATIONS	POWER
42-1271	110V/ 60HZ	$\frac{1}{2}$ HP
42-1272	220V/ 50HZ	$\frac{1}{2}$ HP
42-1275	REPLACEMENT FILTER	

30. Double Shaft Polisher / Dust Collector

A wide body, double spindle polisher with tapered spindles at both ends. The steel enclosure includes a powerful dust collector suction motor. Replaceable fiberglass filters.
 Speed: 3,450 rpm
 Maximum Wheel Ø : 6"
 Dimensions: 32" X 22" X 12"
 Wt. 58 lbs

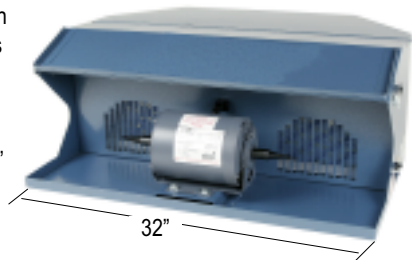

ITEM #	SPECIFICATIONS	POWER
42-1281	110V/ 60HZ	$\frac{1}{2}$ HP
42-1282	220V/ 50HZ	$\frac{1}{2}$ HP
42-1285	REPLACEMENT FILTER	

31. Ikohe Gold Collector

Made in clear acrylic, the gold collector traps precious metals for easy retrieval. Convenient side openings for a comfortable working posture. Includes a magnifier for viewing fine details when working with a flexshaft. Protects your eyes from dust particles. Keeps your work area clean. Stores easily when not in use.
 Dimensions: 280 X 280 X 280MM
 Wt. 10 lbs



ITEM #	DESCRIPTION
42-1381	GOLD COLLECTOR W/ MAGNIFIER
42-1382	MAGNIFIER

32. Matt® Gold Collector

Made of high impact plastic, with a removable plexiglass shield, to provide a convenient enclosure for working of precious metals. Collects articles of gold and other precious metals for easy retrieval. Also protects eyes, skin and clothing while drilling, grinding and brushing.
 Dimensions: 7" X 7" X 9" Wt. 5 lbs

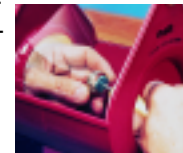

ITEM #	DESCRIPTION
59-3200	GOLD COLLECTOR 3200

33. Heavy Duty Double Shaft/ Polisher / Dust Collector

All steel enclosure, floor model polisher. Supplied with right and left hand tapered spindles. Includes powerful dust collector with replaceable filters. Built in silencer for quiet operation.

Maximum Free Air: 600CFM
 Dimensions: 40" x 28" x 40"
 Wt. 350 lbs



ITEM #	SPECIFICATIONS	POWER
42-1291	110V/ 60HZ- #75-2	$\frac{3}{4}$ HP
42-1292	220V/ 50HZ- #75-2E	$\frac{3}{4}$ HP
42-1295	REPLACEMENT FILTERS - 14 $\frac{3}{4}$ " X 11 $\frac{3}{4}$ "	



Basic Model: JR-1X2-B

Deluxe Model : JR-1C2-B

Double Head Model : SPU-2X4-BA

34. Quatro® Stand Up Polishing Unit

State of the art polishing unit designed to catch all of your gold and other precious metals.

- The most efficient polishing station on the market
- A filtration system that captures all the gold
- Filter efficiency 99.7% on particles 0.3 microns and larger
- Clear view enclosure provides maximum work area
- Inlet below the wheel maximizes gold recovery

Basic Model: JR-1X2-B

- A single station polishing unit that is workplace friendly
- Optional ClearView enclosure for all precious metals
- Unit contains dust filter on one end
- Maximum Free Air: 600CFM
- Dimensions: 19" x 18" x 44" Wt. 90 lbs

Deluxe Model : JR-1C2-B

- A new single station ClearView design
- Cool clean continuous operation
- Capture your gold inside a bag and send it for refining
- Maximum Free Air: 600CFM
- Dimensions: 20" x 24" x 50" Wt. 95 lbs

Double Head Model : SPU-2X4-BA

- Two separate air streams, two separate metals are contained in separate bags
- You can polish gold on one side and platinum on the other
- Three stage filtration to maximize precious metal collection
- Maximum Free Air: 1200CFM
- Dimensions: 40" x 20" x 53" Wt. 175 lbs

ITEM #	DESCRIPTION
42-1406	BASIC JR-1X2-B 110V/1/60 (9.2A)
42-1407	BASIC JR-1X2-B 220V/1/60 (4.7A)
42-1408	DELUXE JR-1C2-B 110V/1/60 (9.2A)
42-1409	DELUXE JR-1C2-B 220V/1/60 (4.7A)
42-1411	DOUBLE SPU-2X4-BA 110V/1/60 (9.2A)
42-1412	DOUBLE SPU-2X4-BA 220V/1/60 (4.7A)
42-1416	PRE-FILTER PAD #AGO44 - PK/20
42-1417	SECONDARY BAGS #AG149
42-1418	HEPA FILTER #F074

35. Quatro® Jet Stream- Clean Air

- Specifically designed for jewelers
- Compact space saving unit
- Ultra quiet performance
- Infinite speed control
- Anti-microbial deluxe filter bag
- HEPA filter

- Unit Includes: Two 4ft hose lengths, 2 adapters and dual inlet
- Dimensions: 10 1/8" X 14 1/4" X 12 1/8"
- Wt. 28 lbs



ITEM #	SPECIFICATIONS	MODEL
42-1431	110V / 60HZ- 1300W	JS-1402
42-1432	220V / 50HZ- 1300W	JS-1402 CE

Quatro® Fresh Air Series-Air Purifiers

Specially designed for high dust levels and for reclaiming airborne precious metal particulate.

Filters also available.

- AF400-D - (up to 250 sq.ft.) Wt.48lbs 42-1510
- AF600-D - (up to 400 sq.ft.) Wt.135lbs 42-1512
- AF1000-D - (up to 600 sq.ft.) Wt.200lbs 42-1514
- AF2000-D - (up to 1200 sq.ft.) Wt.350lbs 42-1516

220V available on order



36. Quatro® Dust Collectors

It is of prime importance to work in a clean air environment. Therefore all grinders and polishers must be connected to a dust collector. Select the model suitable for your shop. Features include a powerful motor blower system, maintenance friendly design, filter cleaning in seconds, and a quick easy slide out tray for the recovery of precious metals. CSA approved, CE Mark.

ITEM #	MODEL	STATION	AIR FLOW	WT.	POWER	DIMENSIONS
42-1441	VELOCITY-X ₁	1	175CFM	65 LBS	110V/60HZ	16" X 14" X 19.5"
42-1442	VELOCITY-X ₁	1	175CFM	65 LBS	220V/50HZ	16" X 14" X 19.5"
42-1444	VELOCITY-X ₂	2	175CFM	73 LBS	110V/60HZ	17" X 14" X 25"
42-1445	VELOCITY-X ₂	2	175CFM	73 LBS	220V/50HZ	17" X 14" X 25"
42-1447	VELOCITY-X ₄	4	580CFM	120 LBS	110V/60HZ	23" X 18" X 25.5"
42-1448	VELOCITY-X ₄	4	580CFM	120 LBS	220V/50HZ	23" X 18" X 25.5"
42-1451	AIR FILTER FOR VELOCITY- X1					
42-1452	AIR FILTER FOR VELOCITY- X2					
42-1453	AIR FILTER FOR VELOCITY- X4					



RING TOOLS

■ Bracelet Stretcher	232
■ ELMA Ringmeter- Germany	233
■ Electric Ring Stretcher	232
■ Finger/Necklace Sizer	235
■ GRS® Ring Size Cutter	234
■ Handheld Ring Clamp	234
■ Inside Ring Engraving Holder	234
■ Inside Ring Holder	232
■ Kagan Ring Roller	232
■ Kagan Wedding Ring Sizer	234
■ Kirkland Ring Clamps- USA	236
■ Lathe Millgrain	236
■ MILLrite - Millgrain Machine	234
■ Outside Ring Holder	235
■ Portable Ring Shears	232
■ Rathburn Ring Stretcher	235
■ Ring Bending Pliers	234
■ Ring Clamps	235
■ Ring Cutter- France	234
■ Ring Gripper	235
■ Ring Guards	235
■ Ring Holding Plier	235
■ Ring Mark A Size	233
■ Ring Mate	233
■ Ring Repair Kit	233
■ Ring Setters Clamp	233

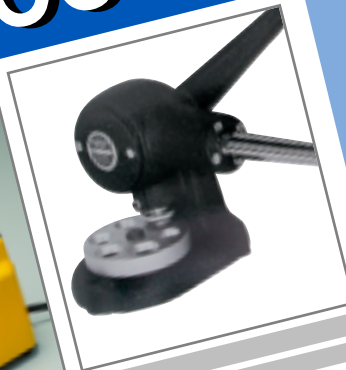

■ Ring Shank Bender	233
■ Ring Stretcher with Reducer	232
■ Ring Stretcher Hand/Bench Mount	232
■ Stone Ring Stretcher	233

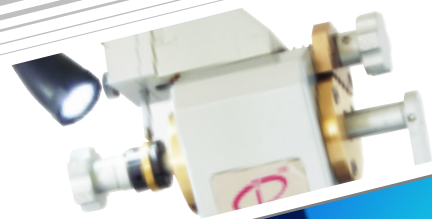

ikohe

GRS

Elma

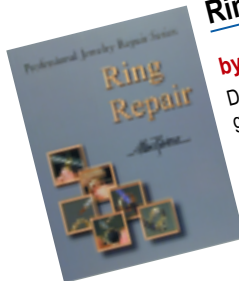

Ring Repair

by Alan Revere

Documents the repair, alteration and restoration of rings in gold, silver and platinum. This book is full of trade secrets and tips and is indispensable to anyone who works with rings. A combination of text and photography presents every step of each project in a clear, concise manner. Includes 140 color photos and 90 sketches.

61-1222 (Soft cover – 128 pages)



43-1011

1. Bracelet Stretcher

An effortless way to enlarge bracelets up to 3" in diameter. The sturdy cast iron base encloses the gear mechanism that spreads the leaf springs on the down stroke and retracts on the up stroke. Do not use for stone set bracelets. Wt. 24 lbs

ITEM #	DESCRIPTION
43-1011	BRACELET STRETCHER
43-1012	REPLACEMENT SPLINE

2. Ring Stretcher with Reducer

A heavy duty upright model that bolts to the work bench. Gradual expansion or reduction of plain ring bands up to size #15 and widths up to 12 mm. Six leaf expansion mandrel is calibrated for approximate ring size. The reduction die is reversible. Not for use on stone set rings. Wt 18 lbs.

ITEM #	DESCRIPTION
43-1021	TWO CONES AND REDUCER
43-1022	SPLINE FOR 43-1021
43-1023	STRETCHER WITH REDUCER
43-1024	SPLINE FOR 43-1023

3. Kagan Wedding Ring Sizer

A top of the line ring stretcher to enlarge or reduce ring size. This sturdy unit bolts to the work bench, is a down stroke model that operates with minimal effort. Accepts all ring sizes up to #14 and widths up to 12mm. The reducing die is reversible and has 12 different ring dies for reduction. Wt 18 lbs.

ITEM #	DESCRIPTION
43-1031	KAGAN SIZER
43-1032	REPLACEMENT SPLINE

4. Kagan Ring Roller

The only enlarger for stone set rings. Precise pressure control on the shank eliminates loosening prongs on a stone set ring. Includes a polished set of eight dies for half round, knife edge and flat ring shanks. May be used as miniature rolling mill for gold, silver or craft wire. Wt. 9.8 lbs.

ITEM #	DESCRIPTION
43-1036	RING ROLLER
43-1037	REPLACEMENT HANDLE

5. Electric Ring Stretcher

Space saving design. Calibrated for all ring sizes #3-13. Power: 110V-240V

- Features:**
- Electronic control
 - Automatic operation
 - Suitable for platinum rings



ITEM #	DESCRIPTION
43-1041	RING STRETCHER

6. Ring Stretcher- Hand/Bench Mount

An easy to operate ring stretcher for enlarging rings. Convert to bench mount using conversion kit. Do not use for stone set rings.



ITEM #	DESCRIPTION
43-1042	RING STRETCHER
43-1043	CONVERSION KIT

7. Rathburn Ring Stretcher

Ideal for ring sizes #6 and larger. Ring is placed over the multi stepped collet and stretching is accomplished by gently tapping the tapered steel plug. Not for use with stone set rings.



ITEM #	DESCRIPTION
43-1045	RING STRETCHER

8. Finger/Necklace Sizer

A well crafted ring sizer in full sizes #3-#24. Made in aluminium alloy chrome coated. Standard scale in inch and cm for measuring necklaces.

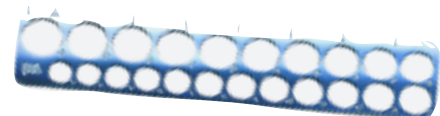

ITEM #	DESCRIPTION
43-1048	SIZER 9" X 2"



9. ELMA Ringmeter-Germany

The Elma digital ring sizer provides quick and easy ring measurements in all international standards. Gauges the finger size, and circumference by a simple one hand operation. Suitable for both left and right hand users. Comes with an elegant cradle and 9V battery.



ITEM #	DESCRIPTION
43-1051	RINGMETER 13-26MM

10. Stone Ring Stretcher

A well made bench unit for enlarging all stone set rings. It stretches the metal for enlarging without loosening prongs or stressing the stone settings. A set of 17 polished rollers is included to suit all ring sizes.



ITEM #	DESCRIPTION
43-1056	RING STRETCHER
43-1057	REPLACEMENT ROLLS

11. Ring Mate

The ideal tool for delicate ring repair. Easy to shape rings to their original form. Tubular stainless steel construction with concealed nylon faced hammer. Calibrated for standard ring sizes.

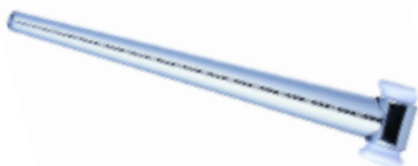

ITEM #	DESCRIPTION
43-1061	RING MATE

12. Ring Shank Bender

A robust tool with a stepped eccentric bending die and matched die blocks. Very useful to bend and shape flat, oval or engraved strip material. Large lever provides effortless working. Comes with two matching dies for sizes #(3-13). Wt.6 lbs.



ITEM #	DESCRIPTION
43-1064	SHANK BENDER

13. Ring Setter's Clamp - Original

A unique tool that allows complete accessibility for setting. Nine nylon inserts to hold all ring sizes from #2- #13. Comes organized in a polished wooden box. An optional accessory is available for mounting in a vise.



ITEM #	DESCRIPTION
23-1271	SETTER'S CLAMP
23-1272	INSERT FOR 23-1271
23-1273	BENCH PIN FOR 23-1271

14. Ring Repair Kit

The ideal bench set for ring repair. The ring mandrel can be rotated and set to any angle for convenient working.

Kit Includes:

The ring mandrel, base and a hammer with changeable heads of brass, nylon and steel.



ITEM #	DESCRIPTION
43-1071	COMPLETE SET
38-1351	HAMMER WITH 3 HEAD SET
38-1352	REPLACEMENT BRASS HEAD
38-1353	REPLACEMENT NYLON HEAD
38-1354	REPLACEMENT STEEL HEAD



15. Inside Ring Holder for Vises

These holders work with all GRS blocks and most vises. Great for stone setting and ring engraving. For extra wide rings, get another collet set and "double-stack" the collets for even more stability.



#004-679 Ring holder with seven collets and key.

16. Handheld Ring Clamp

A light weight GRS ring clamp for stone setting, filing, finishing and polishing. The collar protects your hands and stops it from slipping off the bench pin. Does not fit in BE-020 (BenchMate).



17. Inside Ring Engraving Holder

Ideal for hand engraving the inside of rings. This unique holder secures rings allowing easy access to the inside. May be hand held or mounted in a vise. Made in solid steel to last a lifetime.



ITEM #	DESCRIPTION
43-1081	#004-679 RING HOLDER
23-1362	#004-616 COLLET 7 PCS

ITEM #	DESCRIPTION
43-1084	#004-625 RING CLAMP

ITEM #	DESCRIPTION
43-1085	#004-697 R/HOLDER

18. Setter's Ring Clamp- USA

This ring clamp has an extended lip of a unique design that provides extra support on a workbench. Ideal for polishing and other detail work.



19. Kirkland Ring Clamps- USA

Precision aluminum construction with quick acting thumb screw grip. Indispensable for stone setting, inside working and polishing.



43-1041



23-1042

20. Ring Gripper

Thumb screw clamp gives a firm grip on large or small rings. May be used while buffing and polishing the outside of rings.



ITEM #	DESCRIPTION
23-1052	RING CLAMP -6"

ITEM #	DESCRIPTION
23-1041	COMBINATION CLAMP-5 ³ / ₈ "
23-1042	RING CLAMP-EXTERNAL-6"

ITEM #	DESCRIPTION
23-1053	RING GRIPPER-7 ¹ / ₄ "

21. Inside Ring Holder

Holds large and small rings from the inside, with a firm grip. Enables free working on the outside of the rings without leaving any scratch marks.



22. Ring Clamps

Seasoned hardwood with leather lined jaws, adjustable to fit most rings. This useful tool ensures a positive grip on rings during filing and polishing.



23-1045



23-1048

23. Outside Ring Holder

Holds the outside of large and small rings in either of the two grooves. Enables easy and free working on the inside of rings.



ITEM #	DESCRIPTION
23-1051	RING HOLDER

ITEM #	DESCRIPTION
23-1045	RING CLAMP- RUSSIAN- 6"
23-1046	RING CLAMP- DELUXE - 6"
23-1047	RING CLAMP- PLASTIC 6"
23-1048	RING CLAMP- PARALLEL 6"

ITEM #	DESCRIPTION
23-1055	OUTSIDE R/HOLDER

For Bench Accessories
see page # 42



24. Ring Mark A Size

Mark A Size ring gauge has twelve precision blades with 1/4 size increments. Enables marking of the exact ring shank size for reducing or enlarging.

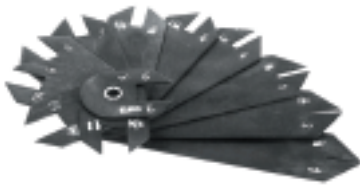

ITEM #	DESCRIPTION
43-1091	RING MARK A SIZE

25. Ring Guards- Gold Filled

Ring guards reduce ring sizes for better fitting and eliminates turning or slippage. Available in yellow or white gold. **Sold / dz.**



ITEM #	COLOR	SIZE
43-1111	YELLOW	SMALL
43-1112	YELLOW	MEDIUM
43-1113	YELLOW	LARGE
43-1114	YELLOW	JUMBO
43-1121	WHITE	SMALL
43-1122	WHITE	MEDIUM
43-1123	WHITE	LARGE
43-1124	WHITE	JUMBO

26. Ring Cutter- France

Durable, top quality ring cutter with safety guard. Slide the jaw between the ring and finger, then turn the handle to cut the ring shank.



ITEM #	DESCRIPTION
43-1094	RING CUTTER DELUXE
43-1095	SPARE BLADE

27. GRS® Ring Size Cutter

USA Model #004-642 : Includes 7 cutters from USA / British size 1/2 to 2 in 1/4" increments.

Metric Model #004-643 : Includes 9 cutters from 1mm to 5mm in 0.5mm increments.

Replacement Cutter Kits

USA / British Cutter Kit **#004-585**: Includes 7 cutters

Metric Cutter Kit **#004-600**: Includes 9 cutters

ITEM #	DESCRIPTION
41-2221	#004-642 USA MODEL
41-2222	#004-643 METRIC MODEL
41-2224	#004-585 USA / BRITISH KITS
41-2225	#004-643 METRIC KITS



ikohe 28. Portable Ring Shears

Easy ring sizing by shearing the exact width that needs to be removed from the ring shank. Install the correct cutter, adjust the die, place the ring on die and shear with a down stroke. Save the cut piece for future use. Includes four cutters (1-5mm) in quarter size increments.

ITEM #	DESCRIPTION
41-1412	RING SHEAR
41-1414	SET OF CUTTERS 5 PCS (1-5MM)
41-1415	REPLACEMENT CUTTER 1MM
41-1416	REPLACEMENT CUTTER 2MM
41-1417	REPLACEMENT CUTTER 3MM
41-1418	REPLACEMENT CUTTER 4MM
41-1419	REPLACEMENT CUTTER 5MM



41-1412

29. Ring Holding Plier

Made of forged polished steel, with lap joints and grooved jaws. These pliers are indispensable for holding rings while working on the insides.



ITEM #	DESCRIPTION
41-1224	GERMAN
41-1234	VALUE

30. Ring Bending Plier -German

Smooth curved jaws, precisely aligned to bend or hold rings while crafting and fabricating.



ITEM #	DESCRIPTION
41-1222	BENDING PLIER-5"
41-1223	BENDING PLIER-6"

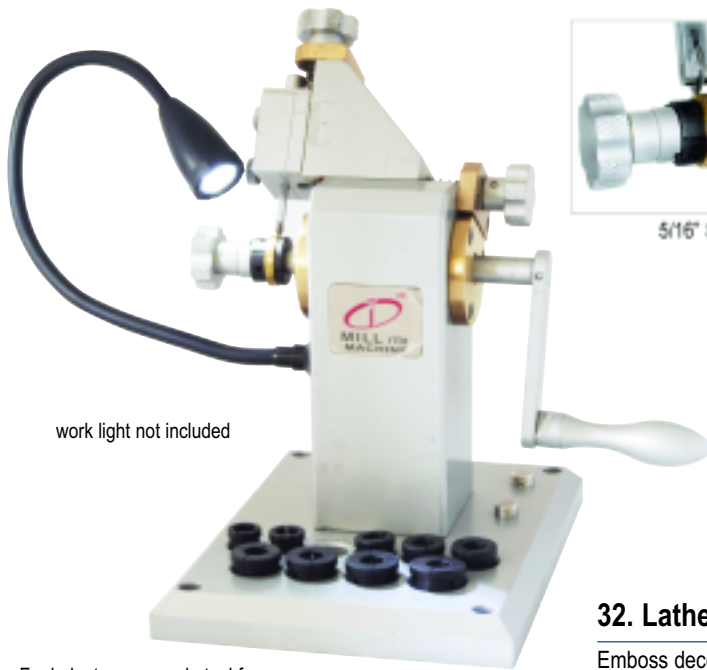

work light not included



5/16" Shank Tool

31. MILLrite - Millgrain Machine

A precision machine to create professional decorative designs on rings, sizes #2-13. Includes a work holding device, a tool clamp, and an ingenious tool positioning system. Easy to operate with minimal effort. Imprinted designs exhibit a high degree of brilliance. Use with lathe millgrain tools.

New Holder for 5/16" Shank Tools: A sturdy tool holder for larger millgrain wheels. Larger wheel face eliminates wobble and extends wheel life. Use on platinum rings.

ITEM #	DESCRIPTION
43-1131	COMPLETE MACHINE
43-1132	SET OF 9 COLLETS
43-1133	MILLIGRAIN TOOL HOLDER 1/8"
43-1134	MILLIGRAIN TOOL HOLDER 5/16"
39-2019	PORTABLE WORKLIGHT LED
43-1231	"V" TOOL 1/8"

32. Lathe Millgrain

Emboss decorative designs on the edges of rings and bracelets. Embossing wheels are 6 mm in diameter mounted on square tool shanks that fit on a millgrain machine or lathe. Wheels are hardened and tempered to ensure long tool life. Select from a variety of patterns to suit individual creations.

Size: 1/8" - Standard

ITEM #	DESIGN	TYPE	ITEM #	DESIGN	TYPE
43-1141		M4-MALE	43-1161		M14-MALE
43-1142		F4-FEMALE	43-1162		F14-FEMALE
43-1143		M6-MALE	43-1163		R1-ROPE
43-1144		F6-FEMALE	43-1164		R2-ROPE
43-1145		M8-MALE	43-1165		R3 ROPE
43-1146		F8-FEMALE	43-1166		K1 C/ EDGE
43-1147		M9-MALE	43-1167		CM13 DIA.
43-1148		F9-FEMALE	43-1168	picture n/a	CM15 SLASH
43-1149		M10-MALE	43-1169	picture n/a	HB DESIGN
43-1150		F10-FEMALE	43-1170		F16-FEMALE
43-1151		M12-MALE	43-1171		CF7
43-1152		F12-FEMALE	43-1172		CF10

Size: 5/16" - Use with 43-1134

ITEM #	DESIGN	TYPE	ITEM #	DESIGN	TYPE
43-1181		M4-MALE	43-1211		M14-MALE
43-1182		F4-FEMALE	43-1212		F14-FEMALE
43-1183		M6-MALE	43-1213		R1-ROPE
43-1184		F6-FEMALE	43-1214		R2-ROPE
43-1185		M8-MALE	43-1215		R3 ROPE
43-1186		F8-FEMALE	43-1216		K1 C/ EDGE
43-1187		M9-MALE	43-1217		CM13 DIA.
43-1188		F9-FEMALE	43-1218	picture n/a	CM15 SLASH
43-1189		M10-MALE	43-1219	picture n/a	HB DESIGN
43-1190		F10-FEMALE	43-1220		F16-FEMALE
43-1191		M12-MALE	43-1221		CF7
43-1192		F12-FEMALE	43-1222		CF10

For indents use a male tool form

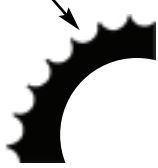

For raised beads use female tool form

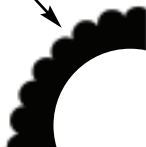

Lathe Millgrain 1/8" Shank Tools



Tool Holder for 1/8" Shank



Tool Holder for 5/16" Shank



5/16" Shank Tool



Lathe Millgrain 5/16" Shank Tools



ROLLING MILLS & DRAWPLATES

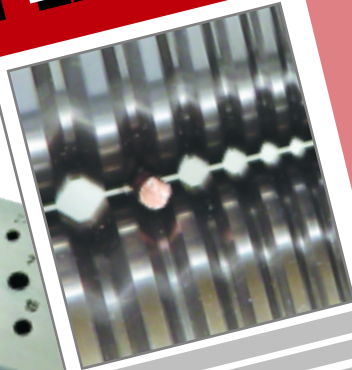
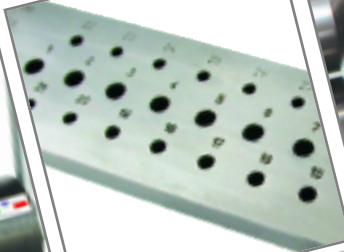
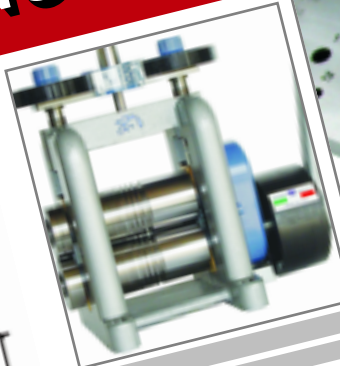
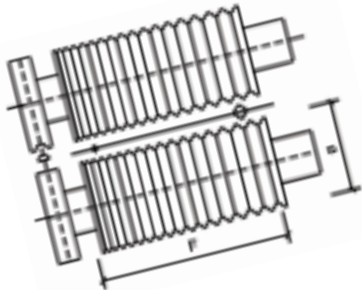

■ Compact Motorized Rolling Mills	240
■ Draw Benches	241
■ Draw Tongs- Value	241
■ Draw Tongs with Ring	241
■ Draw Tongs-Deluxe	241
■ Heavy Duty Motorized Rolling Mills	240
■ Pedestal for Rolling Mills	241
■ Rolling Mills- Italy	239
■ Rolling Mills- Value	241
■ Steel Draw Plates - Italy	242
■ Tungsten Carbide Draw Plates	242

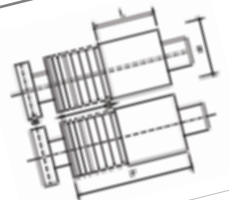
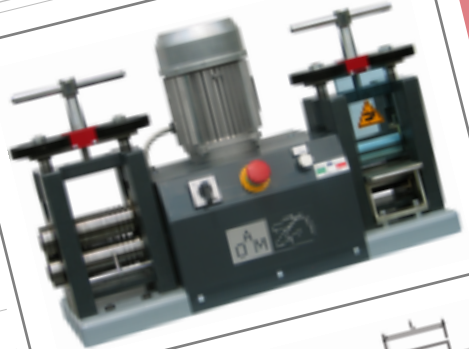

Practical Jewellery Repair

by James Hickling

An excellent reference book about the methods and techniques of the professional jewelry repairer and restorer. Demonstrates a wide range of repair work using modest tools; the various processes and materials required; and stock holding of precious metals, solders and gemstones. Covers and illustrates basic techniques of soldering, casting, wire-drawing, polishing, sawing and filing.

61-1221 (Hardcover – 193 pages)

ikohe

AM
F.lli CAVALLIN

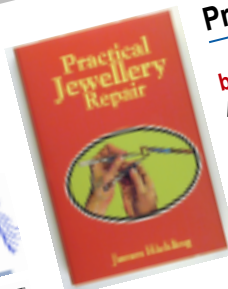

ROLLING MILLS



Rolling Mills

- High quality, sturdy, one piece frame construction
- All steel gear driven rolls can be aligned, raised and lowered
- Alloy steel rolls run in lubricated ball bearings
- Hardened to 62-64 Hrc and surface finished to less than 0.1 um
- Calibrated dial indicates reduction in the sheet size



SERIES						
	Minimum Recommended Strip Width	Cylinder Diameter	Recommended Strip Thickness	Roulette Dimensions	Minimum Dimension Without Handle	Machine Weight
80 MM	5 MM	44 MM	2.5-0.1MM	3.6 X 1.2MM	280X180X340MM	16kg
100 MM	10 MM	52.5 MM	3.5-0.1MM	3.6 X 1.2MM	310X210X380MM	23kg
120 MM	10 MM	65 MM	4.5-0.1MM	3.6 X 1.2MM	340X220X410MM	34kg

Rolling Mills without Gear

1. Rolling Mills-Flat

- Model L - Flat only

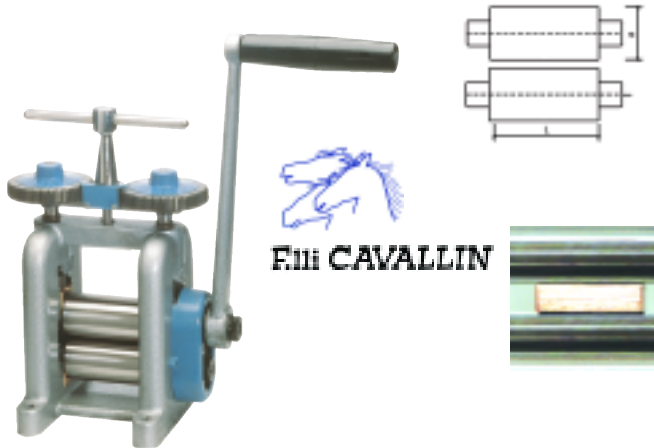

ITEM #	MODEL	L	Ø
44-1112	L80	80MM	44MM
44-1113	L100	100MM	52.5MM
44-1114	L120	120MM	65MM

2. Rolling Mills-Combination-Sq/ Half-Rnd Wire-Mejora

- Model F - Wire only - Mejora
- Individual pattern side rollers are available for this mill

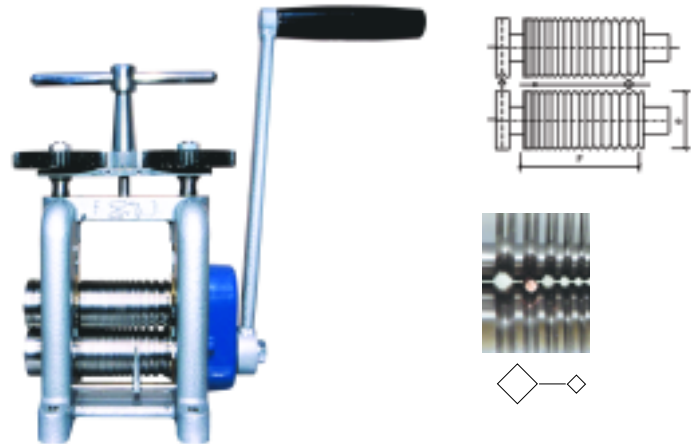

ITEM #	MODEL	F	Ø	SQ.	HF/RND
44-1122	F80	80	44	5-1	44
44-1123	F100	100	52.5	6-1	52.5
44-1124	F120	120	65	7-1	65

3. Rolling Mills-London LF120

- Model LF - Flat, Wire, Half Round with side rollers
- Model LF120 is without reduction gear. Length (L)=36MM

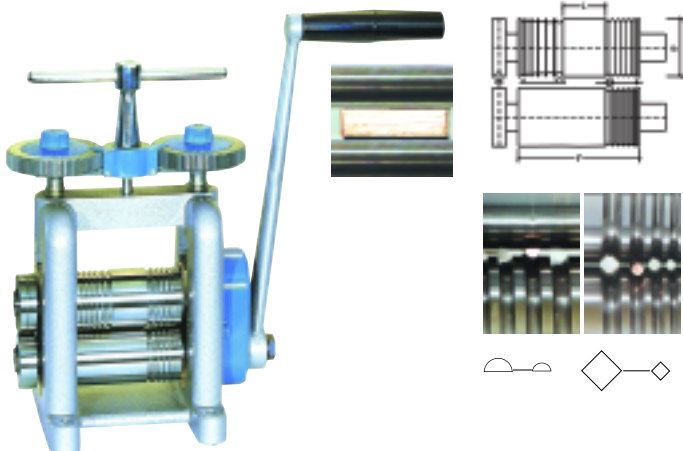

ITEM #	MODEL	F	Ø	SQ.	HF/RND
44-1126	LF120	120	65	4.5-1	5x2 / 2x0.8

4. Rolling Mills Combination Flat/Square Wire-Mejora

- Model LF - Flat and Wire
- Features side rollers to do bracelet patterns.

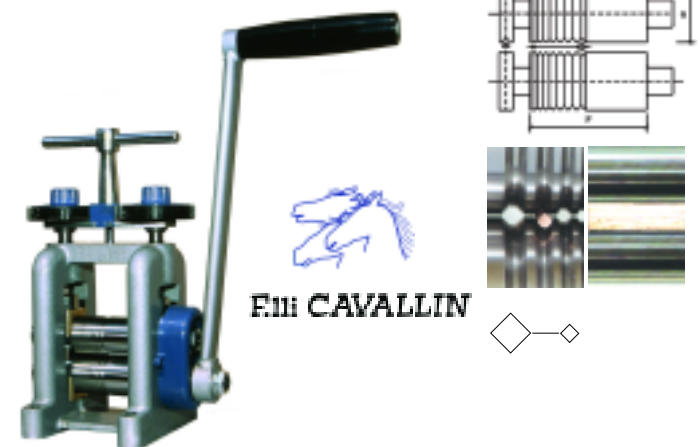

ITEM #	MODEL	F	L	Ø	SQ.
44-1132	LF80	80	58	44	3.5-1
44-1133	LF100	100	50	52.5	4.5-1
44-1134	LF120	120	62	65	6-1

Cavallin Rolling Mills: Spares available on special order.
Warranty will be voided if Rolling Mills are modified.



Rolling Mills with Gear

5. Rolling Mills-with Gear- Flat

- Model LR - Flat with Gear
- Features a gear reduction of 1:4 ratio for effortless rolling

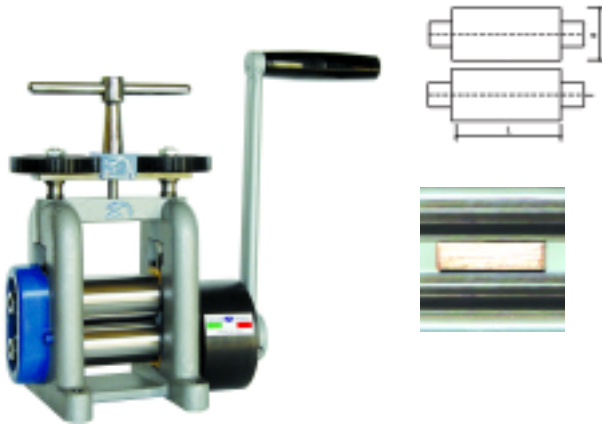

ITEM #	MODEL	L	Ø
44-1136	LR80	80MM	44MM
44-1137	LR100	100MM	52.5MM
44-1138	LR120	120MM	65MM

6. Rolling Mills-London LFR120

- Model LFR- Flat, Wire, Half Round with gear
- Reduction ratio 1:4.

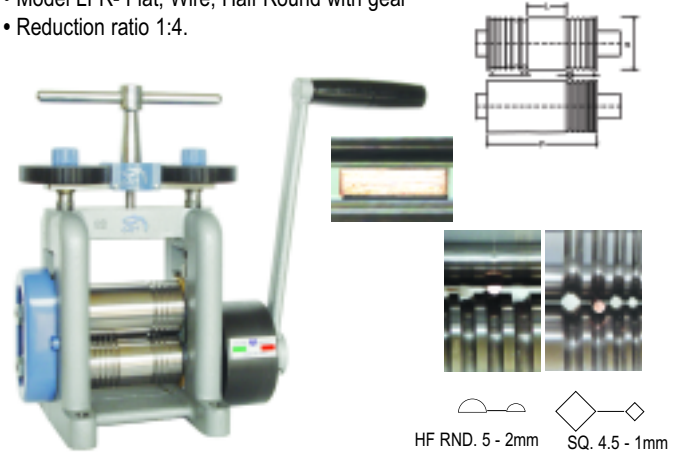

ITEM #	MODEL	F	L	Ø	SQ.	HF/RND
44-1146	LFR120	120	36	65	4.5-1	5x2 / 2x0.8

7. Rolling Mills- With Gear Combination Square/ Half Round Wire- Mejora

- Model LFR - Flat and Wire with Gear
- Individual pattern side rollers are available for this mill.

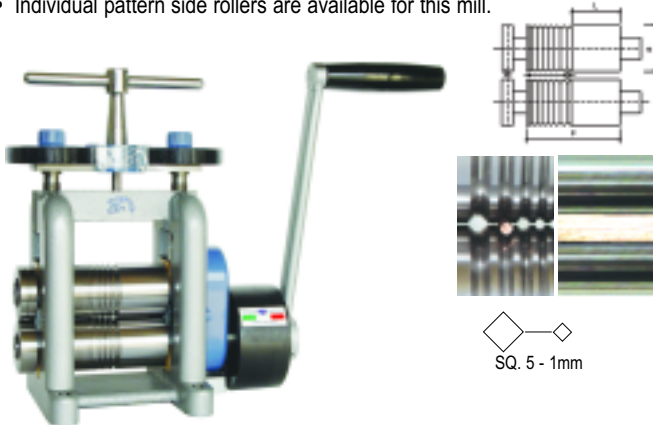

ITEM #	MODEL	F	L	Ø	SQ.	HF/RND
44-1141	LFR100	100	50	52.5	6-1	52.5
44-1142	LFR120	120	60	65	7-1	65

8. Filly 140 / 160 : The Filly 140/160 is a highly flexible machine, configurable for both wire and strip production, with a choice of 140mm and 160mm working tables.

Wire and Strip combinations are available for both 140mm and 160mm working tables for both heads.

All Strip machines supplied with a 160mm table for breaking down, have Mirror Finished Cylinders fitted as standard to a 140mm table for finishing.

All Wire machines are available only in a 160mm working table format, with a single wire coiler unit provided as standard.



Filly CAVALLIN

MODEL	DESCRIPTION
1400	WIRE & STRIP, 140MM HEADS
1600	WIRE & STRIP, 160MM HEADS
1601	DOUBLE STRIP HEADS, 160/140MM
1602	DOUBLE WIRE HEADS, 160MM



Design Rollers:

Available on special order for some models only.

ROLLING MILLS



Compact Motorized Rolling Mills- Available in Single Phase 110V and 220V



MODEL							
COMPACT-1	52.5MM	4-0.1MM	10-40 MM	4.5-1 MM	6.1 m/min	460 X 350 X 470 MM	55 KG
COMPACT-2	52.5MM	4-0.1MM	10-75 MM	6-1 MM	6.1 m/min	750 X 350 X 470MM	85 KG

All wire, and wire/ strip machines are provided with selectable twin speeds, providing variable parameters.

9. COMPACT-1 : A single head bench mounted motorized unit for wire and strip production. Solid cast iron frames support the hardened geared rollers which run in wear resistant bronze bearings. CE approved.



10. COMPACT-2 : A double sided bench mounted rolling mill for reduction or finishing of both wire and strip forms. CE approved.



ITEM #	MODEL	POWER
44-1161	COMPACT-1	110V/60HZ/ 0.75 KW
44-1162	COMPACT-1	220V/50HZ/ 0.75 KW

ITEM #	MODEL	POWER
44-1166	COMPACT-2	110V/60HZ / 0.75 KW
44-1167	COMPACT-2	220V/50HZ / 0.75 KW

Heavy Duty Motorized Rolling Mills- Available in Single Phase 110V and 220V

11. ECO 120: A single head bench mounted motorized unit for either wire or strip production. Solid cast iron frames support the geared roller positioning. Hardened rolls run in wear resistant bronze bearings for extended life. A calibrated dial ensures precise size control. CE approved.

Double 120: The double sided bench mounted rolling mill includes all the features of the ECO 120 with greater capacities for wire and strip forms. CE approved.

MODEL					
ECO 120	10MM	7-1MM	65MM	5-0.1MM	5.1M/MIN
DOUBLE 120	10MM	7-1MM	65MM	5-0.1MM	5.1M/MIN

• Roll Ø X L : 65 X 120mm • Max. Thickness: 5mm • Rolling Tolerance : 0.05mm



Dimensions: 49 X 35 X 50CM
Wt. 75kg



Dimensions: 76 X 35 X 52CM
Wt. 115kg

ITEM #	MODEL	POWER
44-1171	ECO 120 -M16	110V / 0.75 KW
44-1172	ECO 120 -M25	220V / 0.75 KW
44-1176	DOUBLE 120 -M16	110V / 1.10 KW
44-1177	DOUBLE 120 -M25	220V / 1.10 KW

MODEL					
M 120	10MM	7-1MM	65MM	15-0.1MM	3.2M/MIN

• Roll Ø X L : 65 X 120mm • Max. Thickness: 15mm • Rolling Tolerance : 0.05mm

12. M 120 : The M 120 is a highly flexible machine for breaking down and finishing of wire and strip forms. Both sets of rolls operate from the main drive. Lubrication is automatic. Indicator dials ensure precise positioning of the rolls. Pattern rollers are available. Please ask for the design sheet. CE approved.

Dimensions: 74 X 36 X 137CM
Wt. 250 Kg



ITEM #	MODEL	POWER
44-1181	M 120 -M16	110V / 1.10 KW
44-1182	M 120 -M25	220V / 1.10 KW



13. Draw Benches

Manually operated to draw wire forms. This heavy duty machine has a gear reduction system that enables continuous traction on a guided rail. Specific draw plates are needed for round, square, half-round and other profiles. Draw plates must be ordered separately.

TABLE LENGTH		
600MM	106 X 80 X 45CM	35kg
1350MM	170X 80 X 45CM	50kg

ITEM #	LENGTH	WIRE Ø
44-1191	600MM	10MM
44-1192	1350MM	10MM
44-1195	DRAW CLAMP	



14. Pedestal for Rolling Mills

To free up bench working space all Rolling Mills can be mounted on steel pedestals. Floor base plate may be ordered separately.



Floor Base Plate

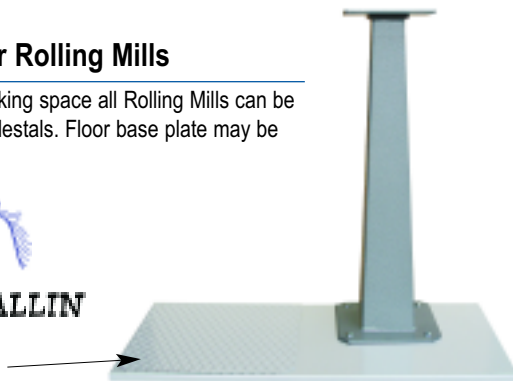

ITEM #	DESCRIPTION
44-1151	COLUMN & PLATE FOR 80MM
44-1152	COLUMN & PLATE FOR 100MM
44-1153	COLUMN & PLATE FOR 120MM
44-1154	COLUMN WITHOUT PLATE
44-1156	FLOOR BASE PLATE

15. Rolling Mills- Value

Compact bench mounted rolling mills. Heavy duty frame, hardened and tempered rolls, gear reduction for ease of operation. Select from three different models for a variety of shapes according to your need.

Rolls are 1.67" Ø and 3" in length.



3 extra Rollers
Comes with 44-1013



ITEM #	FLAT	SQUARE	HF.RND	TEXTURE
44-1011	YES			
44-1012	YES	4-1mm	3-2mm	
44-1013	YES	4-1mm	3-2mm	3 EXTRA ROLLERS

16. Draw Tongs with Ring

All steel forged, draw tongs with "U" handle and ring. Especially for use with larger diameter wire forms for pulling, bending or twisting.



ITEM #	DESCRIPTION
44-1021	DRAW TONG - 8" (200MM)

17. Draw Tongs -Germany

Superior forged steel tongs with a hole in the "T" handle. Facilitates initial start of the draw operation. Extra broad serrated jaws grip metal firmly.



ITEM #	DESCRIPTION
44-1022	DRAW TONG - 8" (200MM)
44-1023	DRAW TONG - 10" (254MM)

18. Draw Tongs- Value

Forged steel tongs have a "T" handle to enable pulling and exerting leverage when drawing or twisting wire. Broad serrated jaws provide a strong non-slip grip.



ITEM #	DESCRIPTION
44-1026	DRAW TONG - 8" (200MM)
44-1027	DRAW TONG - 10" (254MM)



19. Hardened Tool Steel Draw Plates - Italy

Premium quality, hardened steel draw plates with numerous highly polished holes to draw wire down gradually. Always use Bur Lube as a lubricant to draw smoothly and protect the die plate from frictional heat.

ITEM #	PROFILE	SHAPE	RANGE	HOLES
44-1201	●	ROUND	2.00-0.30mm	31
44-1202		ROUND	3.00-0.50mm	31
44-1203		ROUND	6.00-3.00mm	31
44-1212	◐	HALF RND.	4.00-1.00mm	20
44-1213		HALF RND.	3.00-1.00mm	20
44-1215		HALF RND.	6.00-3.00mm	31
44-1221	■	SQUARE	3.00-1.00mm	20
44-1225		SQUARE	6.00-3.00mm	31
44-1231	◌	OVAL	3.00-1.00mm	20
44-1241	▲	TRIANGLE	3.00-1.00mm	20
44-1251	★	STAR	3.00-1.00mm	20

20. Tungsten Carbide Draw Plates - Deluxe

Draw plates have mirror finished carbide inserts for drawing extremely bright, super smooth round wire. Wear resistant carbide is ten times longer lasting than die steel. Use Bur Lube to draw with reduced friction. Made in Taiwan.

ITEM #	PROFILE	SHAPE	RANGE	HOLES
44-1261	●	ROUND	0.245-0.12mm	24
44-1262		ROUND	1.000-0.26mm	24
44-1263		ROUND	2.200-0.26mm	36
44-1267		ROUND	6.000-2.30mm	24

21. Tungsten Carbide Draw Plates- Value

Specialty draw plates with mirror finished wear resistant carbide inserts. Different shapes: round, half-round, square, hexagonal and oval. All sizes clearly marked on the plates. Use Bur Lube to draw with reduced friction.

ITEM #	PROFILE	SHAPE	RANGE	HOLES
44-1271	●	ROUND	2.20-0.26mm	36
44-1272		ROUND	6.00-2.30mm	24
44-1281	◐	HALF RND.	3.00-0.50mm	21
44-1291	■	SQUARE	3.50-0.80mm	36
44-1292		SQUARE	3.00-0.55mm	24
44-1293		SQUARE	3.00-1.00mm	20
44-1301	◈	HEXAGON	3.50-0.80mm	30
44-1303		HEXAGON	5.00-2.10mm	30
44-1311	◌	OVAL	5.00-4.00mm	20

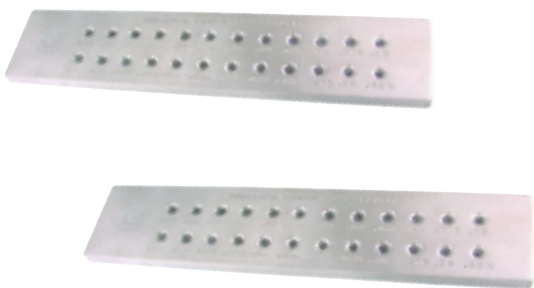
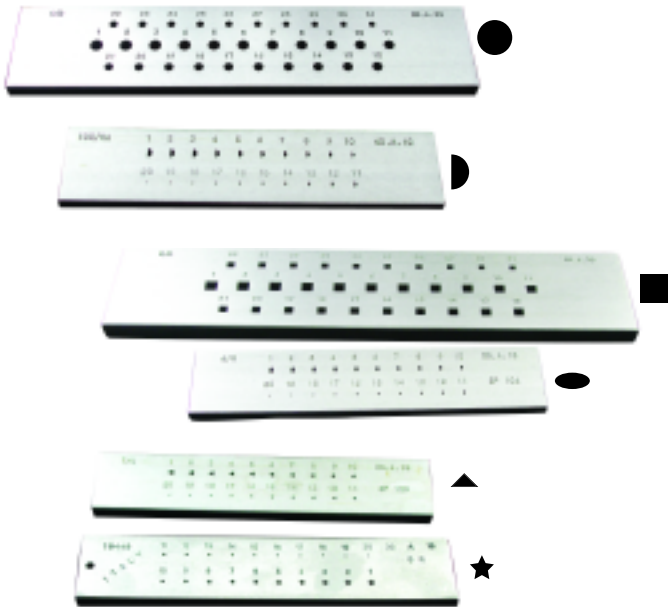

26-3001

**Bur Lube Makes
Wire Drawing Easy**
See page # 80

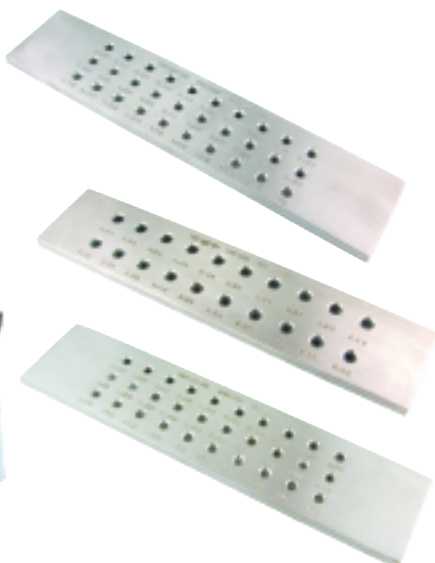

For Draw Benches see
pg# 241



SAFETY

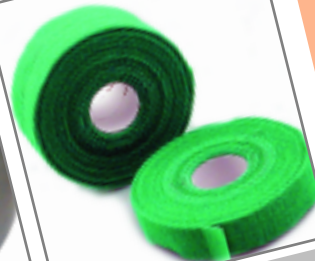

■ 3M® Dust Mask	244
■ Finger Guards	244
■ Lightweight Face Shield	244
■ Safety Apron	244
■ Safety Goggles	244
■ Safety Glasses	244



Diamond Setting: The Professional Approach

by **Robert R. Wooding**

A complete course in stone-setting, basic enough for an apprentice, yet in-depth enough to benefit the experienced setter. Explores various setting techniques and the preparation, use and care of tools. Detailed explanations of pinpoint and prong-setting (round and fancy-cut diamonds), bezel setting, channel setting and bead setting.

61-1231 (Hardcover – 178 pages)



1. 3M® Dust Mask

Complete protection from toxic dust and other harmful airborne particles. The mask is comfortable, filters air and does not interfere with breathing.

45-1011 Bx/30 (8500) 45-1012 Bx/10 (8511)

ITEM #	DESCRIPTION
45-1011	DUST MASK
45-1012	D/MIST RESPIRATOR

4. Safety Apron

Durable denim apron protects clothing at the work place from grime, molten metal and sparks. Provided with easy accessible pockets for small tools.



ITEM #	DESCRIPTION
45-1093	APRON- DENIM
45-1094	APRON- COTTON

7. Safety Goggles- Ventilated

Inexpensive, impact resistant goggles, provide eye protection from sparks and debris during grinding and polishing. Fits over spectacles. One size fits all. Meets ANSI specifications.



ITEM #	DESCRIPTION
45-1018	SAFETY GOGGLES



45-1061



45-1072

45-1071



45-1076/77

* S- Small; M- Medium : L- Large

2. 3M® Safety Glasses

Impact resistant eye shields offer vital protection during bench work, carving, grinding and buffing. Large clear lenses allow a wide field of view.



ITEM #	DESCRIPTION
45-1015	SILVER
45-1016	CLEAR

5. Finger Guard Safety Tape

An alternative to finger guards, protection tape readily adheres and is easy to apply and remove. Made of surgical grade gauze, it conforms to the contours of the finger. Ideal protection from the hazards of sharp edges and hot surfaces.



ITEM #	DESCRIPTION
45-1041	TAPE ¾" X 90' - PK/16
45-1042	TAPE 1" X 90' - PK/12

8. Face Shield with Visor

Made of impact resistant clear view material, it must be worn over spectacles or goggles. Fits easily with an adjustable headband.



ITEM #	DESCRIPTION
45-1031	FACE SHIELD

9. Finger Guards

Leather Finger Guards: Soft leather guard for protecting fingers from compounds, resin and heat.

Suede Finger Guards: Made of soft leather, for comfort, they protect fingers from burns or abrasion during grinding, polishing and finishing. **Deluxe Leather Finger Guards:** Made of soft leather, for a comfortable fit. These fingers guards have an elastic back for free size fit.

ITEM #	DESCRIPTION
45-1061*	SUEDE M- OPEN END
45-1062*	SUEDE L- OPEN END
45-1066*	SUEDE M- CLOSED
45-1067*	SUEDE L- CLOSED

3. 3M® Vetrap™ Tapes

Natural rubber latex, light and durable, this new non-adhesive wrap sticks to itself, but not to the skin. Protects fingers and wrists. Size- 2" wide X 15' length.



ITEM #	DESCRIPTION
45-1051	WHITE
45-1052	PINK
45-1053	RED
45-1054	GREEN
45-1055	BLUE

6. Safety Goggles

Light plastic wrap-around frames with safety colored lenses help protect eyes when melting metal, soldering or brazing.



ITEM #	DESCRIPTION
45-1021	SHADE -3A
45-1022	SHADE -4A
45-1023	SHADE -5A
45-1024	SHADE -7A
45-1025	SHADE -10A



Rubber Finger Cots

See page # 226



Heat Resistant Gloves

See page # 100



SAW FRAMES & BLADES

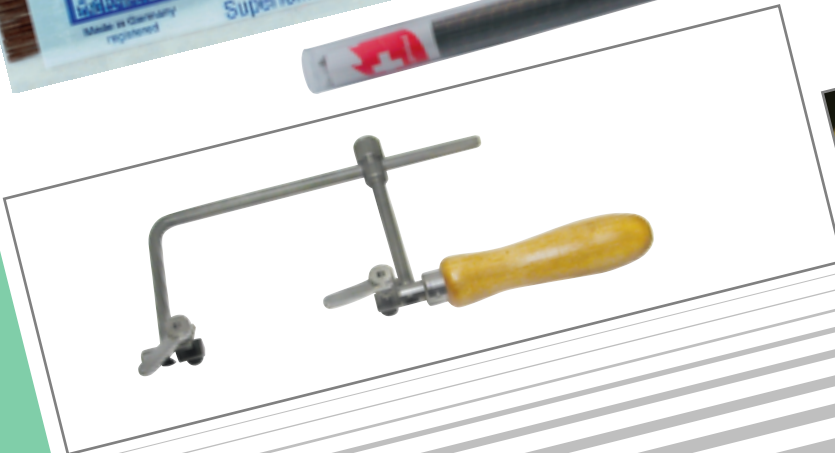
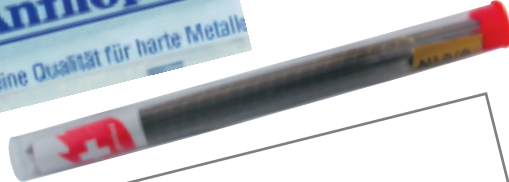

■ Bench Mounted Saw Table	248
■ Bur Lube	248
■ Saw Blades	246
■ Saw Frames	247
■ Sprial Saw Blades	248
■ Tube Cutter	248

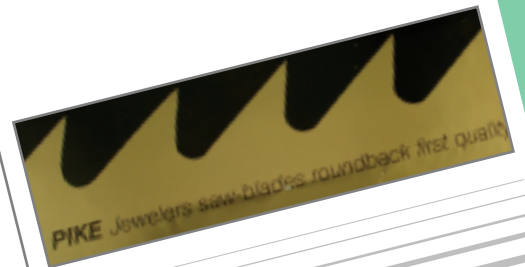

ikohe



GEMS



The Jeweler's Bench Reference

by **Harold O'Connor**

A handy pocket-size reference guide that explains all types of jewelry making techniques. Vital information on fabricating, soldering, stone-setting, plating and casting.

61-1032 (Spiral bound – 68 pages)

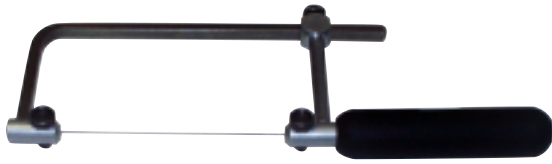

1. Saw Frames- Swiss

This sawframe is adjustable, ultra-light, and perfectly balanced. Ergonomic handle reduces fatigue. Made of quality steel with a non-glare finish.



ITEM #	DESCRIPTION	SIZE
46-1011	SAW FRAME	2-3/4"



46-1014



46-1015

2. Adjustable Saw Frames-Value

Made of the finest materials, this adjustable sawframe is well balanced and has a comfortable hand grip.

ITEM #	DESCRIPTION	SIZE
46-1014	SAW FRAME-OSCAR	3"
46-1015	SAW FRAME-VALUE	3"



46-1021

3. Adjustable Saw Frames - France

Special rectangular profile 5 X 7mm contributes to extra rigidity of the saw frame. Quick tension system by a quarter turn of the tightening lever holds blade taut. Size 80 X 130mm.

ITEM #	DESCRIPTION	SIZE
46-1021	THUMB LOCK	80MM
46-1022*	REGULAR	80MM

*picture not shown



4. Saw Frames with Tension Screw

Forged hardened tool steel adjustable frame with a serrated clamp to hold the blade firmly. Alignment is accurate and a tensioning screw is provided to eliminate blade wobble.

ITEM #	DESCRIPTION	SIZE
46-1031	SAW FRAME	3 3/4"
46-1032	SAW FRAME	4"
46-1033	SAW FRAME	5"

5. Deluxe Saw Frames -France

An excellent saw frame in stainless steel with black varnished wooden handle. Perfect blade alignment is assured by smooth sliding head. Jaws are case hardened tempered steel.

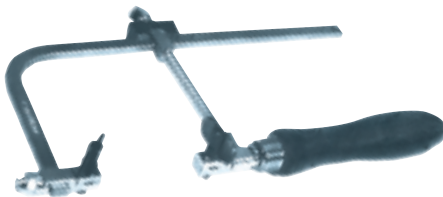

ITEM #	DESCRIPTION	#
46-1041	60MM	0
46-1042	70MM	1
46-1043	85MM	2
46-1044	95MM	3
46-1045	125MM	4
46-1046	150MM	5

6. Adjustable Saw Frames

Forged and hardened tool steel with adjustable frame and serrated clamps to hold the blade firmly. Also accommodates broken blades.



Saw Frames- Germany

ITEM #	DESCRIPTION
46-1051	SAW FRAME -2 1/2"
46-1052	SAW FRAME -3"
46-1053	SAW FRAME -4"
46-1054	SAW FRAME -5"
46-1055	SAW FRAME -6"
46-1056	SAW FRAME -8"
46-1059	WING NUTS

Saw Frames - Value

46-1081	SAW FRAME -2 1/2"
46-1082	SAW FRAME -3"
46-1083	SAW FRAME -4"
46-1084	SAW FRAME -5"
46-1085	SAW FRAME -6"



46-1059



SAW FRAMES & BLADES

7. Sawblades- Swiss

- Premium quality, long lasting tempered steel
- Resists breakage and drifting when cutting
- Art. 104 Yellow color • Measures 13cm (5 1/4")
- Packed one gross (144 blades)



#7/0	#6/0	#5/0	#4/0	#3/0	#2/0	#0	#1	#2	#3	#4	#5
46-1121	46-1122	46-1123	46-1124	46-1125	46-1126	46-1127	46-1128	46-1129	46-1130	46-1131	46-1132



Antilope® Sawblades- Germany

- Made of high quality steel, recognized by jewelers globally
- Art. 100 Yellow color
- Measures 13cm (5 1/4")
- Packed one gross (144 blades)



Art. 101 Blue color also available

#8/0	#7/0	#6/0	#5/0	#4/0	#3/0	#2/0	#0	#1	#2	#3	#4	#5
46-1141	46-1142	46-1143	46-1144	46-1145	46-1146	46-1147	46-1148	46-1149	46-1150	46-1151	46-1152	46-1153

Herkules® Sawblades- Germany

- Herkules sawblades are world renowned for their performance
- Made of special alloy steel, uniformly tempered
- Art 158 Yellow color
- Measures 13cm (5 1/4")
- Packed one gross (144 blades)



Art. 150 White color also available

#8/0	#7/0	#6/0	#5/0	#4/0	#3/0	#2/0	#0	#1	#2	#3	#4	#5
46-1161	46-1162	46-1163	46-1164	46-1165	46-1166	46-1167	46-1168	46-1169	46-1170	46-1171	46-1172	46-1173

Pike® Sawblades- Swiss

- Genuine, premium saw blades made to exacting standards
- Efficient for cutting accurate and precise work
- Measures 13cm (5 1/4")
- Packed one gross (144 blades)

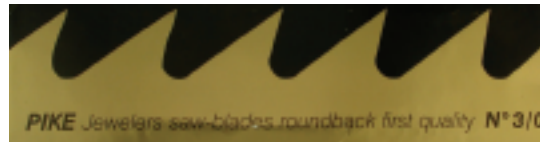

#8/0	#7/0	#6/0	#5/0	#4/0	#3/0	#2/0	#0	#1	#2	#3	#4	#5
46-1181	46-1182	46-1183	46-1184	46-1185	46-1186	46-1187	46-1188	46-1189	46-1190	46-1191	46-1192	46-1193

Expert® Sawblades- Germany

- The finest German sawblade
- Known in the industry for its exceptional flexibility
- Art 180 Yellow color
- Measures 13cm (5 1/4")
- Packed one gross (144 blades)



#8/0	#7/0	#6/0	#5/0	#4/0	#3/0	#2/0	#0	#1	#2	#3	#4	#5
46-1201	46-1202	46-1203	46-1204	46-1205	46-1206	46-1207	46-1208	46-1209	46-1210	46-1211	46-1212	46-1213

Sawblades- Value

- A good quality sawblade at an affordable price
- Measures 13cm (5 1/4")
- Packed one gross (144 blades)



#6/0	#5/0	#4/0	#3/0	#2/0	#0	#1	#2	#3	#4	#5
46-1251	46-1252	46-1253	46-1254	46-1255	46-1256	46-1257	46-1258	46-1259	46-1260	46-1261



H-Drill size

SIZE	T	H
#8/0	0.0063"	80
#7/0	0.0067"	80
#6/0	0.0070"	79
#5/0	0.0080"	78
#4/0	0.0086"	77
#3/0	0.0095"	76
#2/0	0.0103"	75
#1/0	0.0110"	75
#0	0.1100"	73
#1	0.0120"	74
#2	0.0134"	70
#3	0.0140"	70
#4	0.0150"	68
#5	0.0150"	65

Note: #8/0 is smallest size and #5 is the largest size



8. Spiral Sawblades- Germany

- Special form sawblades to cut rubber, plastic, wax and plaster
- Cuts may be made in any direction
- Measures 13cm (5¼")
- Packed one gross (144 blades)

#3/0	#2/0	#0	#1	#2	#3
46-1286	46-1287	46-1288	46-1289	46-1290	46-1291



26-3002



26-3003



26-3001

10. Bur Lube

A carefully formulated compound that provides optimum balance of cooling and lubrication. Reduces friction and heat build up, thereby extending tool life. Essential to use when drilling, cutting or grinding.

ITEM #	DESCRIPTION
26-3001	BUR LUBE 2 OZ.
26-3002	BUR LUBE LIQUID 4 OZ.
26-3003	BUR LUBE PASTE 4 OZ.

9. Circular Saws

Unmounted circular saws made of hardened and tempered steel. Two sizes in 0.10mm thickness with ¼" dia. center holes for mandrel mounting.

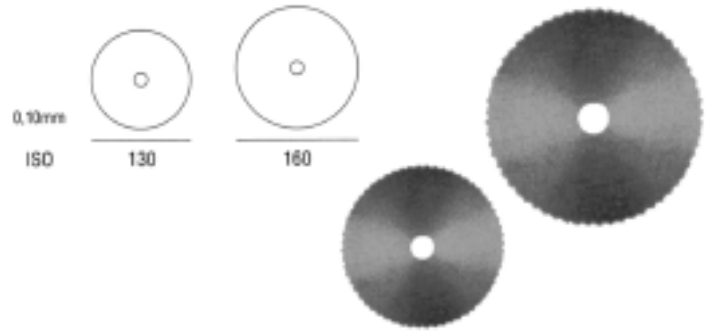

ITEM #	DESCRIPTION
46-1311	CIRCULAR SAW- ¾"
46-1312	CIRCULAR SAW - 7/8"

11. Tube Cutter

Cut rods or tubing up to ½" diameter with precision. This jig is made of steel and is provided with a wooden handle. An adjustable stop allows you to make accurate repeated cuts.

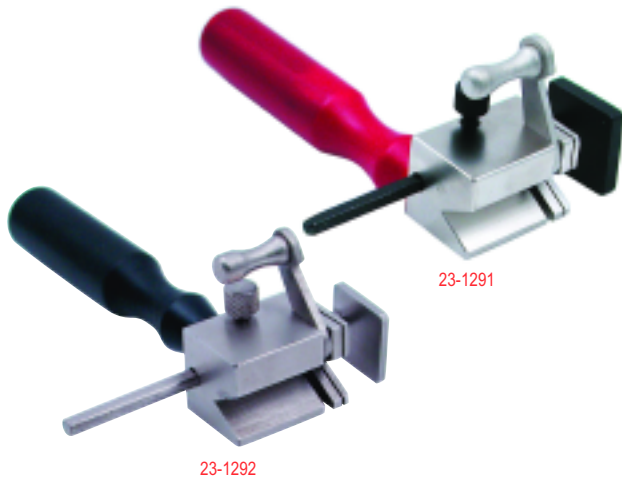

ITEM #	DESCRIPTION
23-1291	DELUXE TUBE CUTTER
23-1292	IKOHE TUBE CUTTER

12. Bench Mounted Saw Table

Made of satin chrome brass, this saw table may be fastened to your work bench. The device permits linear or multi-contoured cuts to be easily made as it allows free movement in all directions. Even thin sheet can be sawed with almost no vibration.

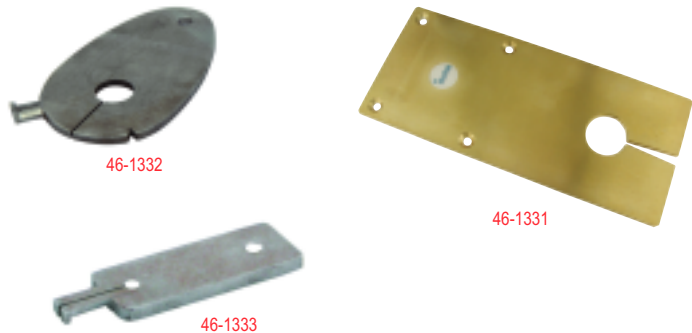

ITEM #	DESCRIPTION
46-1331	SAW TABLE - RECTANGLE 8" X 3½"
46-1332	SAW TABLE - OVAL
46-1333	SAW TABLE - RECTANGLE 3" X 1"



SCALES

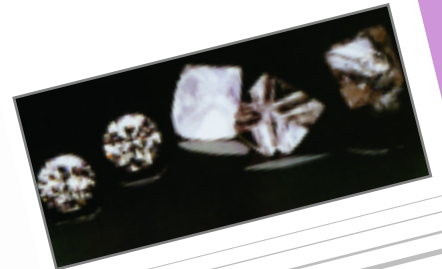
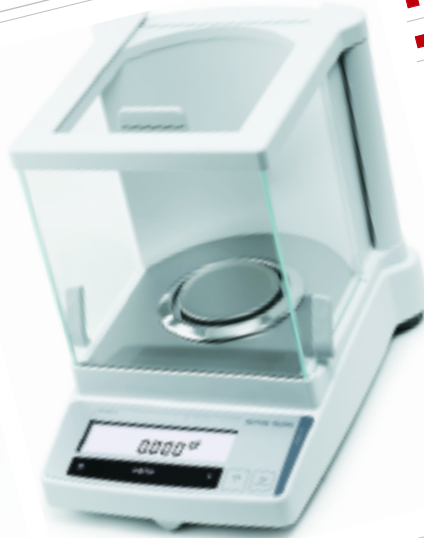

■ A & D® Scales	250
■ Tanita® Scales	251
■ Mettler® Scales	252
■ Ohaus® Scales	254
■ Sartorius® Scales	256



ikohe

sartorius
TANITA

A&D
A&D WEIGHING
...Clearly a Better Value



METTLER **TOLEDO**

Straight Talk on Diamonds

An invaluable reference guide with detailed explanation on the 4C's of diamonds. Includes photographs, diagrams and a CD. Useful for sales personnel at jewelry stores.



61-1234



Multi Weighing Units

oz	Ounce (av)
ozt	Troy oz
tl	Tael
lb	Pound (av)
GN	Grain
dwt	Pennyweight
g	Gram
ct	Carat
mom	Momme
pcs	Pieces

Gold Scales Everest Series- Legal for trade

- LCD display with backlight
- Standard RS232-C interface
- Percentage, counting and comparator function
- Optional rechargeable battery pack
- Full digital calibration
- 1/60,000 ultra high resolution (EK-610i & EK -6100i)
- GLP/ GMP / ISO compliance

EVEREST SERIES

Modes: g, lb, lb-oz, oz, ozt, dwt, ct, mom, GN, t, TL, %, counting

MODEL	110V	CAPACITY	RESOLUTION	REPEATABILITY	LINEARITY	WEIGHING PAN
EK- 600i	47-1366	600G	0.1g	0.1g	±0.1g	133 X 170 MM
EK-1200i	47-1367	1200G	0.1g	0.1g	±0.1g	133 X 170 MM
EK- 6000i	47-1372	6000G	1g	1g	±0.1g	133 X 170 MM
EK- 12000i	47-1373	12000G	1g	1g	±0.1g	133 X 170 MM
EW- 1500i	47-1375	300/600/1500G	0.1/0.2/0.5g	0.2g	±0.2g	133 X 170 MM
EW-12Ki	47-1376	3/6/12KG	1/2/5g	2g	±2g	133 X 170 MM



Options and Accessories are available on special order.



Carat Scales Orion Series- Legal for trade

- Full digital calibration
- GLP / GMP / ISO compliant
- Percentage and counting functions
- Underhook weighing
- Optional: RS-232C current loop
- WinCt CD OM included

ORION SERIES

Modes: g, mg, oz, ozt, dwt, ct, mom, GN, t, TL, %, counting

MODEL	110V	CAPACITY	RESOLUTION	REPEATABILITY	LINEARITY	WEIGHING PAN
HR-60	47-1381	300 CARAT	0.001g	0.0001g	±0.0002g	Ø 85MM



Carat Scales GF Series- Legal for trade

- Super Hybrid Sensor Provides one second response time
- GLP / GMP / ISO compliant
- WinCt CD OM included
- Standard RS-232C
- Counting and Comparator Functions

GF SERIES

Modes: g, lb, lb-oz, oz, mg, oz, ozt, dwt, ct, mom, GN, t, TL, %, counting, custom

MODEL	110V	CAPACITY	RESOLUTION	REPEATABILITY	LINEARITY	WEIGHING PAN
GF-300N	47-1392	310G	0.001g	0.001g	±0.002g	128 X 128MM



TANITA Model 1479 Series Scales



TANITA						
MODEL	110V	CAPACITY	READABILITY	DISPLAY	POWER	DIMENSIONS / WT.
1479V	47-1021	120g	0.1g	4 Digit LCD	3 LR W/Batteries (included)	6 $\frac{1}{8}$ " x 3" x $\frac{5}{8}$ " / Wt. 6oz(170g)
1479S	47-1025	200g	0.1g	4 Digit LCD	LR44 3 batteries (included)	6 $\frac{1}{8}$ " x 3" x $\frac{5}{8}$ " / Wt. 9.3oz(265g)
1479S	47-1026	300g	0.1g	4 Digit LCD	LR44 3 batteries (included)	6 $\frac{1}{8}$ " x 3" x $\frac{5}{8}$ " / Wt. 9.3oz(265g)
1479S-SILVER	47-1028	200g	0.1g	4 Digit LCD	LR44 3 batteries (included)	6 $\frac{1}{8}$ " x 3" x $\frac{5}{8}$ " / Wt. 9.3oz(265g)
1479S-GOLD	47-1029	300g	0.1g	4 Digit LCD	LR44 3 batteries (included)	6 $\frac{1}{8}$ " x 3" x $\frac{5}{8}$ " / Wt. 9.3oz(265g)
1479S* L/TRADE	47-1036	300g	0.1g	4 Digit LCD-Legal for Trade	LR44 3 batteries (included)	6 $\frac{1}{8}$ " x 3" x $\frac{5}{8}$ " / Wt. 9.3oz(265g)

Model 1210-100N 47-1011

CAPACITY	20g, 100ct, 0.64ozt, 308gr
READABILITY	0.002g, 0.01ct, 0.0001ozt, 0.05gr
DISPLAY	4 DIGIT LCD $\frac{1}{4}$ " (7mm) ht.
POWER	4 AAA Alkaline Batteries (included)
DIMENSIONS	6" x 4.3" x 1.1" Wt.:9.3 oz (265g)

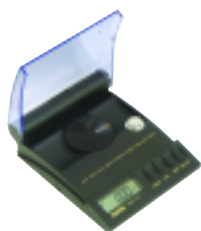

Model 1230 47-1015

CAPACITY	20g, 100ct, 0.64ozt, 308gr
READABILITY	0.002g, 0.01ct, 0.0001ozt, 0.05gr
DISPLAY	5 DIGIT LCD $\frac{1}{2}$ " ht.
POWER	4 AAA Alkaline Batteries (included)
DIMENSIONS	6.2" x 3.3" x 1.1" 8.1oz (230g)



Model 1481 47-1024

CAPACITY	120g, 4.2oz, 3.8ozt, 77.2dwt
READABILITY	0.1g
DISPLAY	4 DIGIT LCD $\frac{1}{4}$ " (7mm) ht.
POWER	4 AAA Alkaline Batteries (included)
DIMENSIONS	3 $\frac{1}{2}$ " X 5 $\frac{3}{4}$ " X $\frac{5}{8}$ " Wt.:3.9 oz (109.7g)



Model KP-103 Tangent Scale- 47-1038

CAPACITY	120g, 4.2oz, 3.8ozt, 77.2 dwt
READABILITY	0.01g, 0.005oz, 0.0005ozt, 0.1dwt
DISPLAY	5 DIGIT LCD $\frac{3}{8}$ " (10mm) ht.
POWER	1 LCR 2032 Watch Battery (included)
DIMENSIONS	4.5" X 3.6" X 0.8" Wt.:3.9 oz (109.7g)



KP-104 300 Tangent Scale 47-1041

CAPACITY	300g / 0.1g 10.580oz / 0.005oz
READABILITY	0.1g
DISPLAY	5 DIGIT LCD $\frac{3}{8}$ " H (10MM)
POWER	1 LCR 2032 Watch Battery (included)
DIMENSIONS	5.4" X 2.4" X 0.8" Wt.:100g / 3.5 oz.



KP-104 200 Tangent Scale 47-1042

CAPACITY	200g / 0.1g 7.055 oz / 0.005 oz
READABILITY	0.002g, 0.01ct, 0.0001ozt, 0.05gr
DISPLAY	5 DIGIT LCD $\frac{3}{8}$ " H (10MM)
POWER	1 LCR 2032 Watch Battery (included)
DIMENSIONS	5.4" X 2.4" X 0.8" Wt.: 100g / 3.5 oz.



Model KP400-Series 47-1031

CAPACITY	400g
READABILITY	0-200g/0.1g 200-400g / 0.2g
DISPLAY	4 DIGIT LCD $\frac{1}{2}$ " (14mm) ht.
POWER	CR2032 (5004LC) 2 batt. (included)
DIMENSIONS	5 $\frac{1}{2}$ " X 7 $\frac{1}{8}$ " X $\frac{1}{2}$ " Net. Wt. 9.5 oz (270g)

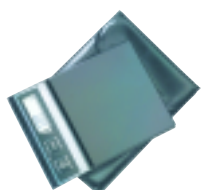

Model 1475 T 47-1034

CAPACITY	20g, 100ct, 0.64ozt, 308gr
READABILITY	0.002g, 0.01ct, 0.0001ozt, 0.05gr
DISPLAY	5 DIGIT LCD $\frac{1}{2}$ " ht.
POWER	4 AAA Alkaline Batteries (included)
DIMENSIONS	6.2" x 3.3" x 1.1" Wt.: 8.1oz (230g)





Carat Scales- Legal for trade

METTLER TOLEDO offers an outstanding range of carat balances for weighing precious stones. JB-C/FACT balances provide additional security - no matter the conditions.

JB-C / FACT

Fully Automatic Calibration Technology.



- /F - FACT Included
- C - Carat
- /A -legal for trade
- Back-lit display • RS232-C interface • Carat pan & protective cover
- Fully Automatic adjustment with internal weight
- Dimensions : 245 X 321 X 280MM
- The JB-L-C balances are identical to the JB-C/FACT balances except they have an external calibration. The calibration weight is included



JB-C / FACT- JEWELRY PLUS

Modes: ct, g, ozt, dwt

MODEL	110V	CAPACITY	READABILITY	REPEATABILITY	LINEARITY	WEIGHING PAN
JB703-C/A-F	47-1151	700CT / 140G	0.001CT/0.001G	0.001CT/0.001G	0.001CT/0.001G	Ø 80MM
JB1203-C/A-F	47-1153	1200CT / 240G	0.001CT/0.001G	0.001CT/0.001G	0.001CT/0.001G	Ø 80MM
JB1603-C/A-F	47-1154	1600CT / 320G	0.001CT/0.001G	0.001CT/0.001G	0.001CT/0.001G	Ø 80MM
JB703-L-C/A	47-1161	700CT / 140G	0.001CT/0.001G	0.001CT/0.001G	0.001CT/0.001G	Ø 80MM
JB1203-L-C/A	47-1163	1200CT / 240G	0.001CT/0.001G	0.001CT/0.001G	0.001CT/0.001G	Ø 80MM
JB1603-L-C/A	47-1165	1600CT / 320G	0.001CT/0.001G	0.001CT/0.001G	0.001CT/0.001G	Ø 80MM

JL-C- Legal for trade

JL-C balances save space, are functional and ideal for sales with a second display. You can be sure that your balance is on spec at all times!

• C - Carat

• /A -legal for trade

- Back-lit display • RS232-C interface for second display
- Carat pan & protective cover
- Adjusting weights • All models with external adjustment
- Dimensions: 194 X 225 X 174MM

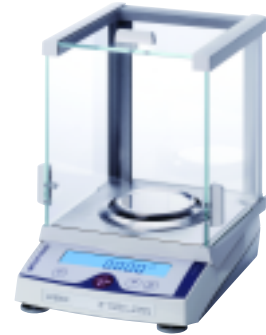

JL-C- JEWELRY LIGHT

Modes: ct, g, ozt, dwt

MODEL	110V	CAPACITY	READABILITY	REPEATABILITY	LINEARITY	WEIGHING PAN
JL502-C/A	47-1155	510CT / 102G	0.01CT/0.01G	0.01CT/0.01G	0.01CT/0.01G	Ø 100MM
JL603-C/A	47-1156	610CT / 122G	0.001CT/0.001G	0.001CT/0.001G	0.001CT/0.001G	Ø 80MM
JL1103-C/A	47-1157	1100CT / 220G	0.001CT/0.001G	0.001CT/0.001G	0.001CT/0.001G	Ø 80MM
JL1503-C/A	47-1159	1510CT / 302G	0.001CT/0.001G	0.001CT/0.001G	0.002CT/0.001G	Ø 80MM

Accessories for Carat and Gold Scales



Auxiliary display JL
Order No. 12102508

47-1191



Auxiliary display
RS/LC BLD
Order No. 224200

47-1192



LC-P45 Printer
Order No. 229119

47-1193



RS-P26 Printer
Order No. 229266

47-1194



Anti-theft device

47-1195



AccuPac
Order No. 21264691

47-1196

All scales come with a warranty. Be sure to fill out your warranty card and register with the manufacturer. For service and other queries please call the manufacturer for assistance.



Gold Scales- Legal for trade

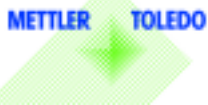

METTLER TOLEDO offers an extensive line of balances that meet Legal for Trade specifications. Jewelers who work with precious metals will have complete confidence in precision, dependability and accuracy.

FACT- Accuracy -The Fully Automatic Calibration Technology initiates the internal adjustment of your balance whenever temperature changes risk affecting the accuracy of your weighing results.

Integrated Applications - All jewelry balances have the most important applications integrated: normal weighing, piece counting and % weighing.

Back-lit Display- This display on all jewelry balances guarantees that results can be easily and securely read. For you - and a second display for your customer.

Performance Guaranteed - Rely on the best - all Mettler Toledo balances are made in Switzerland.



JB-G / FACT

These units include Fully Automatic Calibration Technology so you can be sure that your balance is on spec at all times.



- /F - FACT Included
- G - Gold
- A - Legal for trade
- Back-lit display
- RS232-C interface
- Protective cover
- Fully Automatic adjustment with internal weight
- Dimensions : 245 X 321 X 280MM



JB-G / FACT- JEWELRY PLUS

Modes: g, ct, ozt, dwt

MODEL	110V	CAPACITY	READABILITY	REPEATABILITY	LINEARITY	WEIGHING PAN
JB2002-G/A-F	47-1181	2100G	0.01G	0.01G	0.02G	180MM X 180MM
JB3002-G/A-F	47-1182	3100G	0.01G	0.01G	0.02G	180MM X 180MM
JB4002-G/A-F	47-1183	4100G	0.01G	0.01G	0.02G	180MM X 180MM
JB6001-G/A-F	47-1184	6100G	0.1G	0.1G	0.001G	180MM X 180MM
JB8001-G/A-F	47-1185	8100G	0.1G	0.1G	0.001G	180MM X 180MM

JL-G- Legal for trade

JL-G balances save space, are functional and ideal for sales with a second display. You can be sure that your balance is on spec at all times!

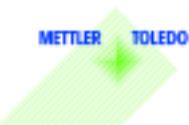

- G - Gold
- A - Legal for trade
- /03 - RS232 interface
- Back-lit display
- RS232 Interface for second display
- Protective cover
- All models have external adjustment
- Dimensions : 194 X 225 X 67MM



JL-G - JEWELRY LIGHT

Modes: g, ct, ozt, dwt

MODEL	110V	CAPACITY	READABILITY	REPEATABILITY	LINEARITY	WEIGHING PAN
JL602-G/A03	47-1171	610G	0.01G	0.01G	0.02G	Ø 160MM
JL802-G/A03	47-1172	810G	0.01G	0.01G	0.02G	Ø 160MM
JL1502-G/A03	47-1174	1510G	0.01G	0.01G	0.02G	Ø 160MM
JL1501-G/A03	47-1173	1510G	0.1G	0.1G	0.2G	Ø 160MM
JL5001-G/A03	47-1175	5100G	0.1G	0.1G	0.2G	Ø 160MM



Scales



- Optional calibration weight
- Compact and functional
- Unique back lit display
- Supplied with AC adapter
- RS232C interface
- NTEP approved



- External adjustable weight
- Compact and functional
- Unique back lit display
- Supplied with AC adapter
- Batteries not included
- RS232C interface



- External adjustable weight
- Compact and functional
- Unique back lit display
- Supplied with AC adapter
- RS232C interface



- Weighs in g, oz, troy oz and pennyweight
- Low battery indicator
- Large high contrast display
- Battery or AC powered
- AC adaptor not included

Ohaus® Adventure Pro- Legal-for-Trade Gram Scales

ITEM #	47-1211
MODEL	AV612N
CAPACITY	610g
READABILITY	0.1g
POWER	4 AA Batteries (not included) or AC (Adapter included)
UNIT MODES	g, kg, ozt, lb, gn, oz, dwt, ct
DIMENSIONS	7.6" X 2.8" X 10"
PAN SIZE	5.8" X 6.3"

Ohaus® Adventure Pro Scales Legal-for-Trade

Weighing, parts counting, percentage weighing, check weighing, display hold, totalization.
UNIT MODES: g, mg, ct, kg, ozt, lb, N, oz, tals(3), gn, units, dwt, ti, m, tola

ITEM #	47-1221	47-1222	47-1223
MODEL	AV53N	AV812N	AV2101N
CAPACITY	51g	810g	2100g
READABILITY	0.02g	0.1g	1g
POWER	4 AA Batteries	4 AA Batteries	4 AA Batteries
LINEARITY	0.01g	0.01g	1g
DIMENSIONS	7.5" X 5.6" X 10"	7.5" X 2.8" X 10"	7.5" X 2.8" X 10"
PAN SIZE	Ø 3.9"	5.8" X 6.3"	5.8" X 6.3"

Ohaus® Sapphire Scales

ITEM #	47-1231	47-1232
MODEL	JS10	JS500
CAPACITY	50ct / 10g	2500ct / 500g
READABILITY	0.01ct / 0.002g	0.5ct / 0.1g
POWER	9 Volt Batteries (not included)	9 Volt Batteries (not included) or AC
UNIT MODES	ct, g, oz, oz t, dwt, gn	ct, g, oz, oz t, dwt
DIMENSIONS	6.75" X 8.25" X 2.4"	6.75" X 8.25" X 2.4"
PAN SIZE	Ø 3"	5" X 5.75"

Ohaus® Ruby Compact Scales

ITEM #	47-1241
MODEL	JR300
CAPACITY	300g
READABILITY	0.1g
POWER	3 AAA Batteries (not included) or AC adapter (sold separately)
UNIT MODES	g, ozt, oz, dwt
DIMENSIONS	8" X 5.5" X 1.5"
PAN SIZE	5.75" X 5.25"



Ohaus® Emerald Scales

ITEM #	47-1251	47-1252	47-1253
MODEL	JE120	JE250	JE500
CAPACITY	120g	250g	500g
READABILITY	0.1g	0.1g	0.1g
MODES	g, dwt, oz t	g, dwt, oz t	g, dwt, oz t
DIMENSIONS	5.35" X 3.25" X 0.8"	5.35" X 3.25" X 0.8"	5.35" X 3.25" X 0.8"
PAN SIZE	3.25" X 3.0"	3.25" X 3.0"	3.25" X 3.0"

Ohaus® Carat Balance **Legal-for-Trade**

ITEM #	47-1262
MODEL	AV264CN
CAPACITY	600ct
READABILITY	0.001ct / 0.005 ct
WEIGHING UNIT	ct, gn, dwt, ozt, g, mg
DIMENSIONS	8.7" X 7.5" X 11.8"
PAN SIZE	Ø 3.5"

Ohaus® Beam Balances

A well equipped balance to handle any weighing job, solids, liquids or powders. The Dial-O-Gram features a spring loaded zero adjuster and dial operation for speed and convenience. The triple beam has three tiered beams with center reading. Both models have stainless steel pans. Includes 10g, 100g, 500g weights one each. * *Extra weights may be ordered separately.*

ITEM #	47-1271	47-1272
MODEL	DIAL "O" GRAM 1610-00	TRIPLE BEAM - 750-SO
CAPACITY	610g -*2160g	610g-*2160g
READABILITY	0.1g	0.1g
DIMENSIONS	18" X 12" X 9"	18" X 12" X 9"
PAN SIZE	6" x 0.8"	6" x 0.8"

Accessories for Ohaus Scales

Scoop, and counter weight 2.25" x 3"	Black Scoop, Aluminum 4" x 3.5"	Gold Scoop 2.25" x 3"	AC power adapter, for ruby and sapphire compact scales
47-1281	47-1282	47-1283	47-1284



Scales



- Unique hand-held design
- Quick and easy calibration
- Unique back lit display
- Weighs in g, oz, troy oz and pennyweight
- 2AAA batteries included

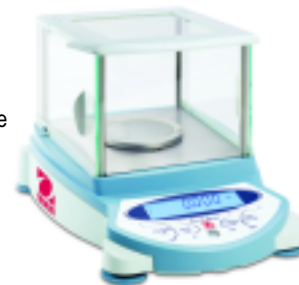

- Legal for trade -NTEP
- Frameless draft shield for easy access with removable doors
- InCal internal calibration included
- Quadrastance for superior stability
- Bright backlit 2 line display



47-1271



47-1272

All scales come with a warranty. Be sure to fill out your warranty card and register with the manufacturer. For service and other queries please call the manufacturer for assistance.

WEIGHT CONVERSION CHART

	DWT	TROY OZ	GRAM	KILOGRAM	AVOIRDUPOIS OZ
DWT	—	0.05	1.555	0.0016	0.0549
TROY OUNCE	20	—	31.003	0.0311	1.097
GRAM	0.643	.03215	—	0.001	0.0353
KILOGRAM	643	32.14	1000	—	35.27
AVOIRDUPOIS	18.23	0.9114	28.35	0.1378	—

KARAT	THOUSANDTH
14K	585
18K	750
20K	832
22K	917



sartorius Scales

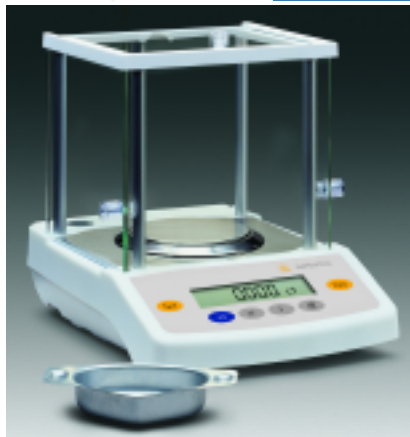

* GD series: Battery pack optional



* GC series: Battery pack optional

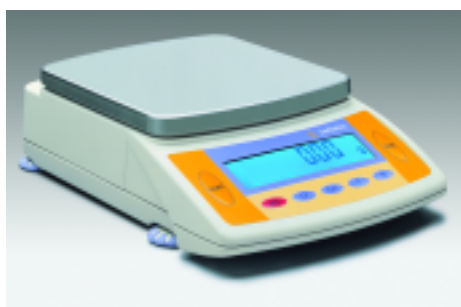

* GP series: Battery pack optional

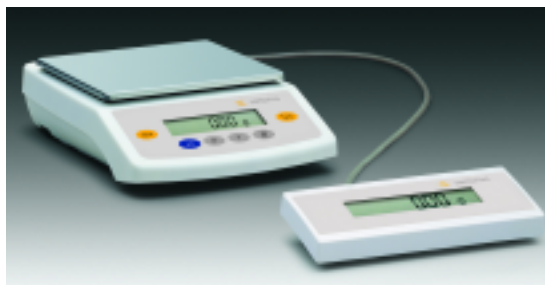

** GE1302, GE2102 : Batteries not supplied.

Carat and Gold scales that combine ease of operation with precise, ultra-fast results.

- Large blue backlit display for easy viewing
- Extra large weighing pans
- RS232C connection for immediate print out proof on an optional printer
- Features all international weights used in the jewelry trade
- CE approved

Sartorius® Carat Scales- GD Series

ITEM #	47-1311
MODEL	*GD603
CAPACITY	605 ct
READABILITY	0.001ct
CALIBRATION	100g (included)
DIMENSIONS	7.9" X 9.9" X 9.2"
PAN SIZE	Ø 3.1"



Triangular shaped weighing pan

Ø= diameter of inner circle.
Extra area offers 27% more space

Sartorius® Carat Scales- GC Series

ITEM #	47-1321	47-1322	47-1323
MODEL	*GC803S	*GC1603P	*GC2502
CAPACITY	800 ct	800ct - 1600ct	2500ct
READABILITY	0.001ct	0.001ct / 0.01 ct	0.005ct / 0.01ct
CALIBRATION	Built-in	Built-in	200g included (external)
DIMENSIONS	8.4" X 13.5" X 10.6"	8.4" X 13.5" X 10.6"	8.4" X 13.5" X 10.6"
PAN SIZE	Ø 3.1"	Ø 3.1"	Ø 4.3"

Sartorius® Gold Scales- GP Series

ITEM #	47-1331	47-1332	47-1333
MODEL	GP3202	GP5202	GP8201
CAPACITY	3200g	5200g	8200g
READABILITY	0.01g	0.01g	0.1g
CALIBRATION	2 kg (optional)	2 kg (optional)	5 kg (optional)
DIMENSIONS	8.4" X 13.5" X 3.5"	8.4" X 13.5" X 3.5"	8.4" X 13.5" X 3.5"
PAN SIZE	7.5" X 8.0"	7.5" X 8.0"	7.5" X 8.0"

Sartorius® Gold Scales- GE Series

ITEM #	47-1341	47-1342	47-1343
MODEL	**GE1302	**GE2102	GE4101
CAPACITY	1300g	2100g	4100g
READABILITY	0.01g	0.01g	0.1g
CALIBRATION	1 kg (optional)	1 kg (optional)	2 kg (optional)
POWER	8 "AA" Batteries	8 "AA" Batteries	AC Adapter (included)
DIMENSIONS	7.4" X 9.8" X 2.8"	7.4" X 9.8" X 2.8"	7.4" X 9.8" X 2.8"
PAN SIZE	6.9" X 5.6"	6.9" X 5.6"	6.9" X 5.6"



SCREWDRIVERS



- Precision Screwdriver Sets 258
- Precision Screwdrivers- France 258
- Reversible Blade Screwdrivers 258
- Screwdrivers Anti-Magnetic 258
- Screwdrivers -Regular 258

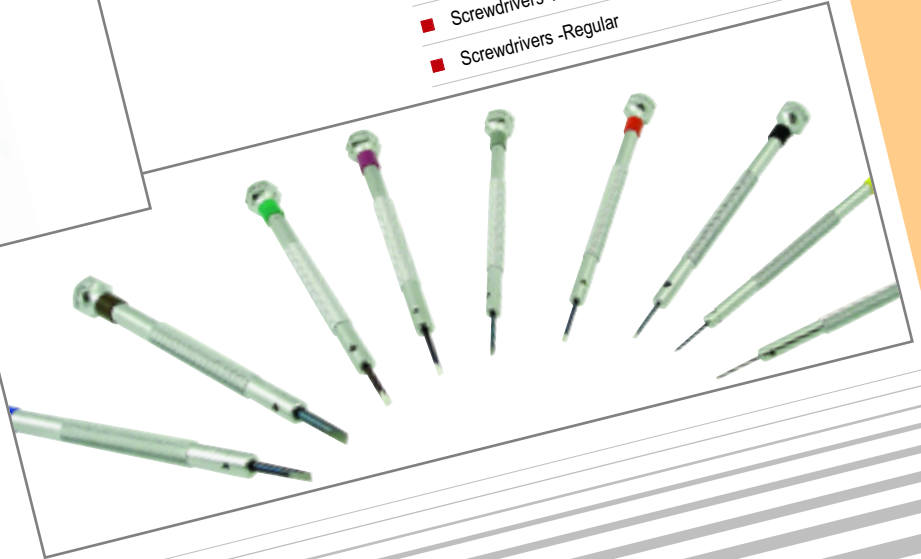

 **ikohe**



Professional Goldsmithing **A Contemporary Guide to Traditional**

Jewelry Techniques by Alan Revere

An indispensable reference guide to the art of handcrafting fine jewelry for both beginners and professionals. Combines over 400 color photos and 140 illustrations with charts, tables and step-by-step projects. Learn how to make rings, bracelets, chains, clasps, earrings and necklaces.

61-1081 (Hardcover – 226 pages)

SCREWDRIVERS



1. Precision Screwdrivers- France

Premium quality screwdrivers in chrome plated brass. Hexagon head rotates on ball bearings for sensitivity. Color coded to indicate size.
Blades are anti-magnetic, tempered and precision ground.



SIZE	COLOR	PRECISION
0.5MM	GREEN	48-1011
0.6MM	PINK	48-1012
0.8MM	YELLOW	48-1013
1.0MM	BLACK	48-1014
1.2MM	RED	48-1015
1.4MM	GRAY	48-1016
1.6MM	VIOLET	48-1017
1.8MM	ORANGE	48-1018
2.0MM	GREEN	48-1019
2.5MM	BLUE	48-1020
3.0MM	BROWN	48-1021

For Bergeon® Screwdrivers see page #316

2. Regular Screwdrivers- France

High quality screwdrivers with tool steel blades heat treated for toughness to withstand wear. Bodies are knurled for a non-slip grip. Color coded to indicate size.



SIZE	COLOR	REGULAR
0.6MM	PINK	48-1032
0.8MM	YELLOW	48-1033
1.0MM	BLACK	48-1034
1.2MM	RED	48-1035
1.4MM	GRAY	48-1036
1.6MM	VIOLET	48-1037
1.8MM	ORANGE	48-1039
2.5MM	BLUE	48-1040
3.0MM	BROWN	48-1041

3. Reversible Blade Screwdrivers- France

- Precision screwdrivers in chromium plated brass
- A mini chuck grips the blade at the lower end
- Blades are ground on both sides • Overall length 80mm • Color coded

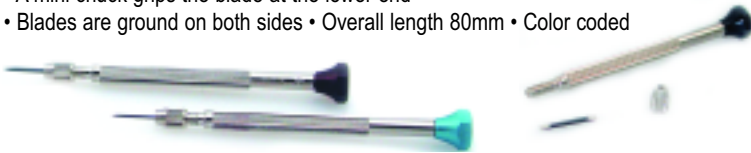

SIZE	COLOR	S/ DRIVERS	SIZE	COLOR	BLADES
0.5MM	VIOLET-10	48-1061	0.5MM	VIOLET-10	48-1051
0.6MM	BLUE-9	48-1062	0.6MM	BLUE-9	48-1052
0.7MM	WHITE-8	48-1063	0.7MM	WHITE-8	48-1053
0.8MM	RED-7	48-1064	0.8MM	RED-7	48-1054
1.0MM	BROWN-6	48-1065	1.0MM	BROWN-6	48-1055
1.2MM	GREEN-5	48-1066	1.2MM	GREEN-5	48-1056
1.3MM	BLACK-4	48-1067	1.3MM	BLACK-4	48-1057
1.5MM	YELLOW-3	48-1068	1.5MM	YELLOW-3	48-1058

4. Precision Screwdriver Sets- France

Precision nine piece set of screwdrivers with replaceable blades. Anodized hexagon head rotates on ball bearings. Included with each set are 19 blades and two screws. Range from 0.6 to 3 mm. Color coded to indicate size.



48-1072



48-1071

ITEM #	DESCRIPTION
48-1071	SET 9 PCS- WOODEN BOX (W/EXTRA TIPS)
48-1072	SET 9 PCS- ON ROTATING STAND

5. Screwdriver Sets

Screwdriver sets, chrome plated, knurled grip all fitted with precision ground steel blades. Color coded for identification.



48-1088



48-1081



48-1086



48-1085

ITEM #	DESCRIPTION
48-1081	STAND W/STONE SET 7 PCS (0.6-2.5MM)
48-1082	STAND ONLY WITH STONE
48-1085	SET OF 6 PCS (0.8-2.0MM)-FIXED
48-1086	SET OF 6 PCS (0.7-1.5MM) -REVERSIBLE
48-1088	SET OF 10 PCS (0.8-3.0MM)



SETTING TOOLS

■ 3M® Glue Gel	266
■ 3M® Quick-Fix Adhesive	266
■ Adjustable Scraper	261
■ Attack® Epoxy Solvent	266
■ Beading Blocks	264
■ Beading Tool Sets	264
■ Bezel Mandrel	261
■ Bezel Pusher	262
■ Bezel Roller	260
■ Burnishers	261
■ Burnishers-Steel	262
■ Channel Setting Set	262
■ Claw Setting Jig	266
■ Crystal Cement	266
■ Devcon® Epoxy	261
■ Double-Ended Steel Tracer	266
■ Epoxy 220/330	262
■ Final Touch	265
■ Hardwood Shellac Holders	261
■ Holder with Chuck	263
■ Inside Ring Setter's Set	265
■ Jett Sett®	260
■ Margin Roller	263
■ Millgrain Tools	264
■ Millrite Millgrain Machine	264
■ Opticon® Fracture Sealer	266



■ Peg Clamp Holder	260
■ Prong Lifter	262
■ Prong Lifting Pliers/ Open / Closing	260
■ Prong Pusher	266
■ Quick Fix Adhesive	262
■ Ring Setter's Flanges	260
■ Setter's Tube Holder	263
■ Setting Burnisher Sets	265
■ Shellac Flake & Sealing Waxes	265
■ Stone Setter's Cement	264
■ Swiss Beading Tools	260
■ Tennis Bracelet Holder	261
■ Wood Handle Scrapers	261



Channel Setting Diamonds with Illustrated Procedures

by **Robert R. Wooding**
Step-by-step channel setting techniques from basic to advanced. Common channel setting problems with workable solutions. Over 124 illustrations.

61-1232 (Hardcover – 136 pages)

 **ikohe**



3M®



SETTING TOOLS



1. Prong Lifting Pliers

Special lap joint pliers with a double leaf spring. Provides gentle pressure on the prong and no pressure on the stone to avoid mar or fracture. One jaw is grooved to hold the prong and the other angled to support the under side to raise the prong gently.



ITEM #	DESCRIPTION
41-1245	PRONG LIFTING PLIER-5"

2. Prong Opening Plier

Open prongs without fracturing stones. The upper angled jaw has a claw and the lower jaw a groove. The prong is supported at the base to avoid pressure on the top of the stone. Features box joint, double leaf springs and a cushion grip.



ITEM #	DESCRIPTION
41-1141	PRONG OPENING PLIER

3. Prong Closing Plier

Single squeeze action closes opposite prongs over stones. Bent jaws with grooved ends securely hold prongs. Features perfectly aligned jaws, double leaf springs and a cushion grip.



ITEM #	DESCRIPTION
41-1142	PRONG CLOSING PLIER

4. Burnishers

Micro-grained, super hard tungsten carbide will smooth and finish all metals including platinum. Silver or gold will not adhere to this burnisher. Also available in steel.

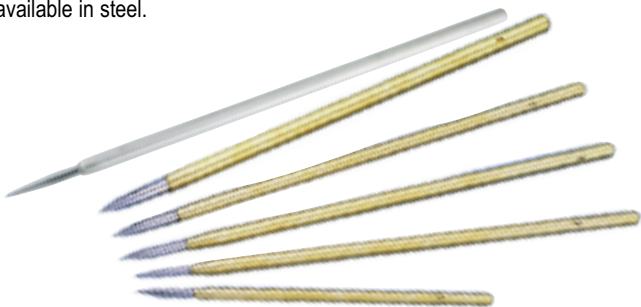

ITEM #	DESCRIPTION
23-1071	TUNGSTEN CARBIDE $\frac{5}{32}$ " Ø - 8"L
23-1072	STEEL $\frac{1}{8}$ " Ø BRASS HANDLE - 8"L
23-1073	STEEL $\frac{1}{8}$ " Ø BRASS HANDLE - 5½"L
23-1074	STEEL $\frac{5}{32}$ " Ø BRASS HANDLE- 8"L
23-1075	STEEL $\frac{3}{16}$ " Ø BRASS HANDLE - 8"L
23-1076	STEEL $\frac{1}{4}$ " Ø BRASS HANDLE LG- 8"L

5. Setter's Tube Holder

Comfortably shaped wooden handle has reinforced metal threaded spindle with chuck. Accepts interchangeable collets to hold tubes during stone setting. Sizes from $\frac{1}{32}$ " to $\frac{1}{8}$ ". (7 collets)



ITEM #	DESCRIPTION
49-1011	SETTER'S TUBE HOLDER

6. Peg Clamp Holder

Hand held holder with moveable pins to hold any odd shaped parts. Remove handle to fit in a vise. Useful when engraving and setting.



ITEM #	DESCRIPTION
23-1059	PEG CLAMP HOLDER

7. Tennis Bracelet Holder-Deluxe

All metal clamp, secures bracelet easily, eliminating the use of shellac. A relief on the diameter provides a space to nest the clasp.



ITEM #	DESCRIPTION
23-1061	BRACELET HOLDER - 3¼" DIA.

8. Margin Rollers

Individually sized burnishing tool that effectively removes porosity, pits or scratch marks on the inside of rings and bracelets.



ITEM #	DIAMETER	SHANK
23-1131	8 MM	$\frac{3}{32}$ "
23-1132	10 MM	$\frac{3}{32}$ "
23-1133	12 MM	$\frac{3}{32}$ "



SETTING TOOLS

9. Double-Ended Steel Tracer

A hardened steel scribe with precise sharpened points at both ends. Highly accurate for marking layout work when designing.



ITEM #	DESCRIPTION
23-1083	DOUBLE END TRACER-4½"

10. Burnishers-Steel

Polished, straight or curved steel blade, with comfortable hardwood handle. These tools may be used to open or close bezel settings in hard to reach places. Overall length 6".

23-1111



23-1112



ITEM #	DESCRIPTION	LENGTH
23-1111	STRAIGHT- 1¾" BLADE	6"
23-1112	CURVED - 2" BLADE	6"

11. Bezel Mandrel- USA

Quite simply, the fastest way to form bezels in different shapes. May also be used to make decorative wire forms. These mandrels are made of case hardened steel, precision finished and polished. Mandrel portion is approx. 8" long with a ½" to ⅝" taper

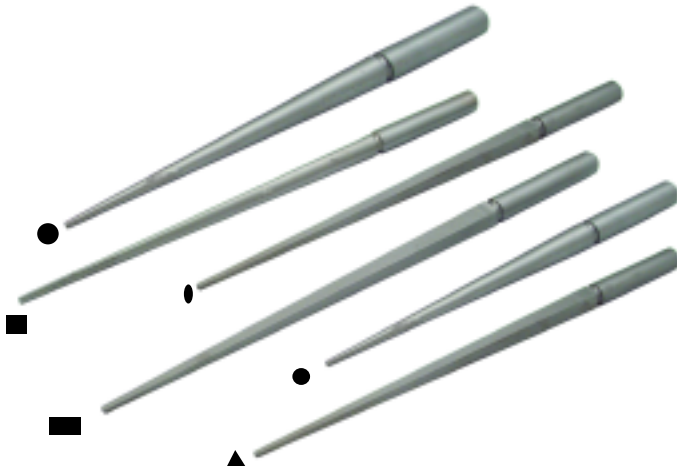

ITEM #	SHAPE	LENGTH
35-1121	ROUND	8"
35-1122	ROUND	11"
35-1123	SQUARE	11"
35-1124	RECTANGLE	11"
35-1125	TRIANGLE	11"
35-1126	OVAL	11"

12. Agate Burnishers

Made of natural stone, straight or knife edged, this super polished surface smooths all marks or other imperfections on jewelry.

23-1115



23-1116



ITEM #	DESCRIPTION
23-1115	STRAIGHT- 8½"
23-1116	KNIFE EDGE- 8"

13. Wood Handle Scrapers

Economical steel scrapers in chrome alloy steel. A three square blade in solid or hollow shape mounted in hardwood handle. Overall length 7".

23-1117



23-1118



ITEM #	DESCRIPTION	BLADE LG.
23-1117	SCRAPER -HOLLOW	2½"
23-1118	SCRAPER -SOLID	2½"

14. Adjustable Scraper

This adjustable scraper has a holder and a lock screw to permit the setting of the hollow tool bit. Useful for fine detail and scraping of excess solder.



ITEM #	DESCRIPTION
23-1121	SCRAPER 3⅞" LONG- FRANCE
23-1122	SCRAPER 3⅞" LONG- VALUE

15. Holder with Chuck

A hand tool with a hardwood palm grip and a metal screw chuck to secure the shank of millgrain wheels.



23-1261



23-1262



23-1263



23-1264

ITEM #	DESCRIPTION
23-1261	ROUND
23-1262	MUSHROOM
23-1263	PEAR
23-1264	TAPERED SPINDLE



16. Bezel Pusher

Square faced, hardened and polished steel pusher, mounted in a hardwood handle. Use for the initial tightening of prongs and beads.



ITEM #	DESCRIPTION
49-1015	BEZEL PUSHER

17. Prong Pusher

A quality tool having a comfortable wood shaped handle with a grooved steel end. Use to push prong or crown points with unfailing accuracy.



ITEM #	DESCRIPTION
49-1016	PRONG PUSHER

18. Bezel Roller

Effortless method for rolling bezels around stones in rings. The semi circular highly polished steel head gently folds the metal over the stone.



ITEM #	DESCRIPTION
49-1019	BEZEL ROLLER

19. Prong Lifter

This new design has the advantage of opening cabochon with the additional feature of a prong pusher. Titanium coating is five times harder than steel and has a long life. Comes with a comfortable plastic grip handle.



ITEM #	DESCRIPTION
49-1021	PRONG LIFTER -REGULAR
49-1022	PRONG LIFTER -TITANIUM COATED
49-1023	PRONG LIFTER -VALUE

20. Final Touch

Extremely easy to use for setting stones. Snap in prongs with a single light tap. The polyurethane base has numerous cavities to locate various stone sizes during setting.



ITEM #	DESCRIPTION
49-1027	FINAL TOUCH

21. Claw Setting Jig - Swiss

A complete set for making four, six or eight large or small prongs. Filing or sawing may be done while the setting is held in the jig.



ITEM #	DESCRIPTION
49-1028	CLAW SETTING JIG

22. Ring Setter's Flanges

A set of brass flanges in pairs to clamp wide or narrow band ring sizes #(1-15) in a vise without any mars. Useful for setting, engraving or repair work.



ITEM #	DESCRIPTION
49-1033	RING SETTER'S FLANGES

23. Channel Setting Set- for Faro Handpiece #10

Incorporate this precise system to set stones professionally. A complete set that fits to the handpiece and allows you to control the cutting depth for channel set stones. This kit ensures stones are set straight, parallel and firmly in place.



Handpiece not included

ITEM #	DESCRIPTION
49-1031	CHANNEL SETTING SET



SETTING TOOLS

24. Inside Ring Setter's Set - Original

A universal tool that allows all around accessibility for setting. Nine nylon inserts cover the entire range of ring sizes from #2- 13. The head unscrews for alternative mounting in a vise.



Special Bench Pin: Use this bench pin with the setters inside ring clamp. This fixture provides access to all around workability, contributing to higher productivity.



23-1273

ITEM #	DESCRIPTION
23-1271	RING SETTER'S CLAMP
23-1272	INSERTS FOR 23-1271
23-1273	BENCH PIN FOR 23-1271

26. Millgrain Tool Set

High quality millgrain tools for forming decorative edges on settings and bezels. Complete set organized in a polished wooden box.



23-1252



23-1251

ITEM #	DESCRIPTION
23-1251	SET OF 6 (#10-15)
23-1252	SET OF 12 (#1-12)
23-1255	BOX ONLY

Millgrain Wheels- France

A professional tool for decorative designs on all articles of jewelry. Use these tools with a millgrain holder. See page #46 for more details.

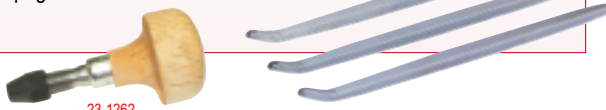

23-1262

25. Setting Burnisher Sets

Multiple uses as setting closers, burnishing or finishing tubes over stones. All sets include a heavy duty handle to secure the tool. Select from four sets.

SET OF 12- FRENCH



Closes prongs on settings Ø1.00- 8.00MM.

ITEM #	DESCRIPTION
49-1041	SET OF 12 -FRENCH

SET OF 18- FRENCH



Closes prongs on settings Ø1.00- 8.00MM.

ITEM #	DESCRIPTION
49-1042	SET OF 18 -FRENCH

SET OF 24- FRENCH



Closes prongs on settings Ø1.00- 8.00MM.

ITEM #	DESCRIPTION
49-1043	SET OF 24 -FRENCH

SET OF 29- GERMAN



Closes prongs on settings Ø2.00- 9.00MM.

ITEM #	DESCRIPTION
49-1044	SET OF 29 -GERMAN

27. Set of 16- value

Closes prongs on settings Ø1.50- 9.00MM.

ITEM #	DESCRIPTION
49-1047	SET OF 16 -VALUE





28. Swiss Beading Tools- Original

Hardened and polished concave tools for beading. Used to form beads to hold diamonds and other stones in mountings. Overall length 60mm with 2.35mm shank. **Sold bx/100**

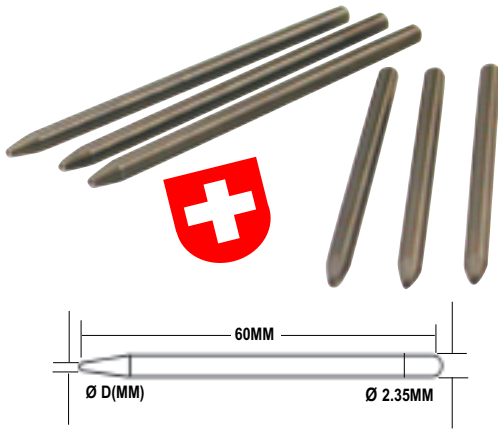

ITEM #	SIZE / Ø	ITEM #	SIZE / Ø	ITEM #	SIZE / Ø
49-1100	#0/0.25	49-1108	#8/0.65	49-1116	#16/1.05
49-1101	#1/0.30	49-1109	#9/0.70	49-1117	#17/1.10
49-1102	#2/0.35	49-1110	#10/0.75	49-1118	#18/1.15
49-1103	#3/0.40	49-1111	#11/0.80	49-1119	#19/1.20
49-1104	#4/0.45	49-1112	#12/0.85	49-1120	#20/1.25
49-1105	#5/0.50	49-1113	#13/0.90	49-1121	#21/1.30
49-1106	#6/0.55	49-1114	#14/0.95	49-1122	#22/1.35
49-1107	#7/0.60	49-1115	#15/1.00		

29. Beading Tool Sets

Steel tool has concave tip that puts beads on prongs to secure stones in mountings. Set of 12 from #5-16 (0.5 to 1.05mm). Set of 23 from #0-22 (0.25 to 1.35mm). All on plastic stands with a handle.

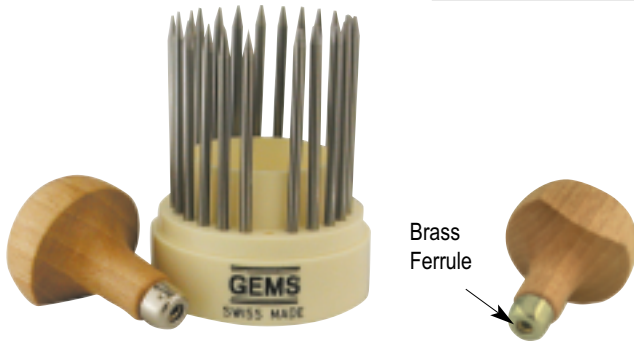

ITEM #	DESCRIPTION
49-1131	BEADING TOOL 12 PCS SET
49-1132	BEADING TOOL 23 PCS SET
49-1135	BEADING TOOL HOLDER
49-1136	BEADING TOOL ORGANIZER

31. MILLrite - Millgrain Machine

A precision machine to create professional decorative designs on rings, sizes #2-13. Includes a work holding device, a tool clamp, and an ingenious tool positioning system. Easy to operate with minimal effort. Imprinted designs exhibit a high degree of brilliance. Use with lathe millgrain tools. See details on page #236



ITEM #	DESCRIPTION
43-1131	* COMPLETE MACHINE
39-2019	PORTABLE WORKLIGHT LED

* Worklight not included

30. Beading Blocks -Imported

Precision formed round or rectangular shapes in hardened polished tool steel. These blocks are essential to re-shape the ends of beading tools.

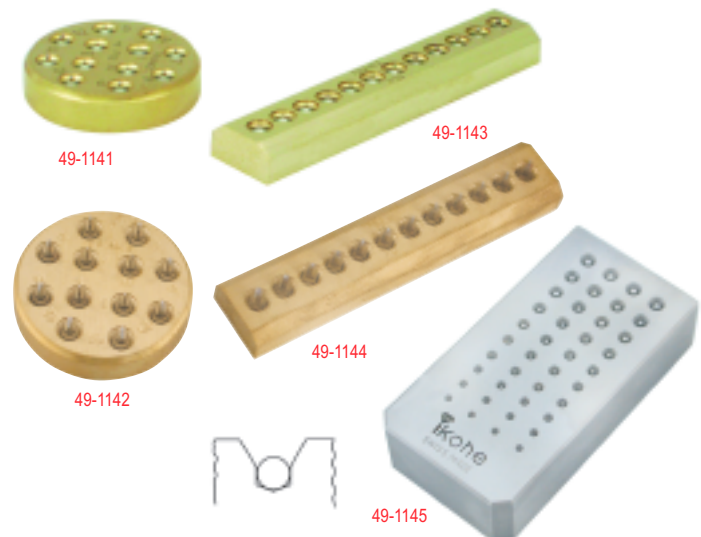

ITEM #	DESCRIPTION
49-1141	SUNK-ROUND-12 HOLES -FRANCE
49-1142	RAISED-ROUND-12 HOLES -FRANCE
49-1143	SUNK-RECT. 12 HOLES -FRANCE
49-1144	RAISED-RECT. 12 HOLES -FRANCE
49-1145	40 HOLES (0.60-1.75MM) -SWISS



32. Hardwood Shellac Holders

Shellac holders are available in round, flat face and rotating types. This hand held accessory holds the work piece while chasing, setting and engraving. Surfaces may be bonded with heated shellac to retain the article. The rotating wheel type may be locked in any position by a wing nut to allow viewing. To remove articles dissolve in denatured alcohol.

ITEM #	DESCRIPTION
49-1151	ROUND 4"- COATED SHELLAC
49-1152	ROUND 5"- COATED SHELLAC
49-1156	FLAT FACE-1½"
49-1157	FLAT FACE-2"
49-1159	BRACELET HOLDER



33. Stone Setter's Cement

Forms an excellent bond for stones when melted and applied to dops. Securely holds the stone for polishing and finishing.

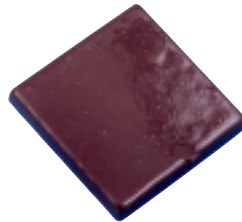

ITEM #	DESCRIPTION
49-1217	SETTER'S CEMENT- 4" X 4" X 5/16"

34. Shellac Flakes & Sealing Wax

Very useful for securing odd shaped articles of jewelry when stone setting. Shellac becomes soft with application of heat, and hardens with cold water. Release articles by dissolving in denatured alcohol.



ITEM #	DESCRIPTION
49-1211	SEALING WAX - STICK 1 LB USA
49-1212	SEALING WAX - STICK 1 LB DELUXE
49-1213	SHELLAC FLAKES 1 LB

35. Jett Sett®

An easy to use thermoplastic formulated compound that becomes pliable when placed in warm water. Hardens in a few minutes. What's more, it adheres to smooth surfaces and can be softened and re-used. Increase your efficiency by creating special devices and supports, for holding, setting and engraving any jewelry items. Use the Little Dipper pot for controlled heat when working with Jett Sett.

Jett Sett Tools

Threaded Handle Tool: Used for holding cup fixtures at any angle.

Cup Fixtures: Three sizes and screws on to the handle tool.

Flat Fixturing Tool: Accommodates several pieces of jewelry for production.

Multi Bracelet Fixturing Tool: For holding bracelets while setting.

ITEM #	DESCRIPTION
49-1251	JETT SETT PLASTIC - 1 LB. BAG
49-1254	THREADED HANDLE TOOL
49-1255	FLAT FIXTURING TOOLS
49-1256	MULTI BRACELET FIXTURING TOOLS
49-1257	CUP FIXTURE 1¼"
49-1258	CUP FIXTURE 1½"
49-1259	CUP FIXTURE 2¼"
49-1261	RING TOOL HOLDER
50-1136	LITTLE DIPPER POT-110V





36. Devcon® Epoxy

High strength two part epoxy. Clear, non-shrink formula. Sets in five minutes and achieves full strength in one hour. Use to bond wood, glass, stone, crystal and ceramics. Available in a tube dispenser or dual pack.

ITEM #	DESCRIPTION
49-1228	EPOXY/HARDENER 1 OZ. TUBE
49-1229	EPOXY/HARDENER 1 OZ. DUAL PK.

37. 3M® Glue Gel

A fast curing gel, bonds in a minute, and is very easy to apply. Needle tip dispenser fills small voids and forms a strong bond. Useful to bond jewelry, glass, stone, plastic and wood.

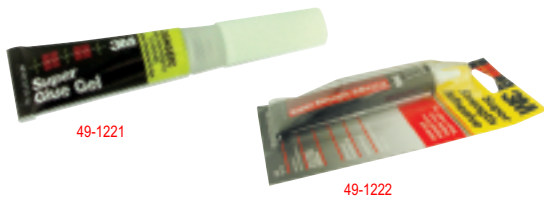

ITEM #	DESCRIPTION
49-1221	SUPER GLUE GEL-6001
49-1222	SUPER STRENGTH-6004

39. 3M® Quick-Fix Adhesive -08155

A fast bonding adhesive that has excellent resistance to temperature extremes. Bonds rubber, glass, metals, vinyl and plastics.



ITEM #	DESCRIPTION
49-1223	QUICK FIX ADHESIVE-1 OZ.

41. Attack® Epoxy Solvent

A solvent to separate bonded items by dissolving epoxy without affecting the base material. Useful on metal, glass, wood and other materials.



ITEM #	DESCRIPTION
49-1236	ATTACK® EPOXY - 8 FL. OZ.

38. Epoxy 220/330

Epoxy 220: A heat resistant epoxy for bonding findings to stone. Has a higher tensile strength. Air curing time approx. 8 hours. Low heat reduces curing time.

Epoxy 330: A clear epoxy for invisible bonds on glass, stone, or findings. Exhibits a high polish on inlay work. Air curing time approx. 2 hours. Apply light heat to reduce curing time.



ITEM #	DESCRIPTION
49-1225	EPOXY 220
49-1226	EPOXY 330

40. Crystal Cement

A crystal clear adhesive for setting gemstones and watch crystals. Fine tip control for accurate application. Net wt. 1/8 oz.



ITEM #	DESCRIPTION
49-1227	CRYSTAL CEMENT

42. Opticon® Fracture Sealer

A two part epoxy that penetrates hair line cracks, and is very effective for sealing fractures in stones. 8 fl oz sealer, 1 oz hardener.



ITEM #	DESCRIPTION
49-1235	FRACTURE SEALER



SOLDERING

■ Batters® Hard Soldering Flux	272
■ Binding Wire-Iron	271
■ Borax® Powder	273
■ Boric Acid Powder	273
■ Ceramic Ring Stand	268
■ Ceramic Soldering Blocks	270
■ Ceramic Tweezers - for Platinum	268
■ Charcoal Block	271
■ Cold Shield	272
■ Cool Paste	271
■ Copper Tongs	268
■ Cyber-Therm Tweezers	272
■ Dandix Paste Flux	269
■ GRS® Third Hand Soldering Stations	272
■ Handy® Flux	270
■ Honeycomb Soldering Blocks	273
■ Magic Soldering Products	271
■ Magnesia Block	273
■ Needle Tip Flux Dispenser	271
■ Picklers	274
■ Platinum Solders- Cadmium Free	274
■ Plumb Solders- Cadmium Free	273
■ Pump Flux Dispenser	273
■ Red Sable Brushes	268
■ Ring Soldering Tweezers	268
■ Rotating Soldering Table	270



■ Sheet Repair Solders- Cadmium Free	274
■ Silver Solders	274
■ Solder Cutting Pliers	274
■ Solder Pastes	268
■ Solder Pic- (Tungsten/Titanium)	270
■ Soldering Boards	268
■ Soldering Tweezers	271
■ Sparex® Pickling Compound	272
■ Stay Bright Soldering Kit	271
■ Thermic Isolator Grain	269
■ Third Hand -Holders	272
■ Tix Solder	268
■ UV Filter	273
■ Yellow Ochre	273



ikohe

GRS

Practical Jewellery Repair

by James Hickling

An excellent reference book about the methods and techniques of the professional jewelry repairer and restorer. Demonstrates a wide range of repair work using modest tools; the various processes and materials required; and stock holding of precious metals, solders and gemstones. Covers and illustrates basic techniques of soldering, casting, wire-drawing, polishing, sawing and filing.

61-1221 (Hardcover – 193 pages)

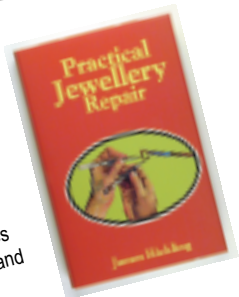



1. Cyber-Therm Tweezers

Unique tungsten steel alloy withstands temperature up to 3000°C for 5-10 minutes. Handles protected by insulating sleeves of heat resistant rubber.



ITEM #	DESCRIPTION
56-1148	CYBER THERM- 145MM

3. Soldering Tweezers

Cross locking stainless steel tweezers with serrated tips and fiber handles, to protect hands from heat when soldering. Overall length 6¾".

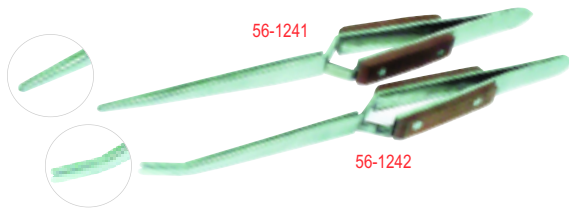

ITEM #	DESCRIPTION
56-1241	SOLDERING TWEEZER -STRAIGHT
56-1242	SOLDERING TWEEZER -BENT

5. Ceramic Tweezers - for Platinum

High quality, *non-magnetic, anti-static*, light weight aluminum body tweezers. Indispensable when soldering or working with platinum jewelry.



ITEM #	DESCRIPTION
56-1146	CERAMIC TWEEZERS
56-1147	CERAMIC TIP ONLY (PAIR)

7. Solder Free Tweezers

Swiss made, anti-magnetic, *acid resistant tweezers*. Will not contaminate solder flux. Solder will not adhere to the ends. Size 6½".



ITEM #	DESCRIPTION
56-1158	SOLDER FREE TWEEZERS

2. Solder Pics - Tungsten / Titanium

Non-stick tungsten and titanium tips are used to prevent solder from adhering. Durable, long lasting with a wooden handle.

50-1011: Tungsten tip for platinum soldering.

50-1012: Titanium tip for gold and silver soldering.



ITEM #	DESCRIPTION
50-1011	SOLDER PIC- TUNGSTEN TIP
50-1012	SOLDER PIC- TITANIUM TIP

4. Ring Soldering Tweezers

Made of stainless steel with a serrated base and slide lock. Ideal for holding shanks and settings in position when soldering.



ITEM #	DESCRIPTION
56-1151	HEAD AND SHANK -SWISS
56-1295	HEAD AND SHANK -VALUE
56-1231	INSIDE R/HOLDING TWEEZERS

6. Ceramic Ring Stand

Ceramic tapered rod on a heavy base to suit all ring sizes. Mounted on a universal base to position the article at any angle.

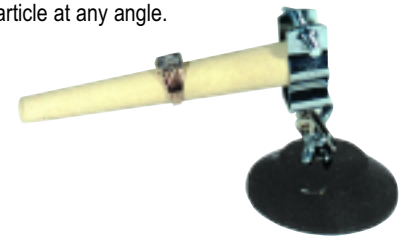

ITEM #	DESCRIPTION
50-1015	HOLDER WITH BASE
50-1016	REPLACEMENT CERAMIC ROD

8. UV filter for Third Hand Base

Mount this UV filter on the arm of the third hand base (50-1021), see page-#45. Then set it to any desired position. This will provide adequate protection when soldering.



ITEM #	DESCRIPTION
50-1024	UV FILTER*

* UV filter is to be used with third hand base 50-1021 see page #45



9. Third Hand Holders

50-1021: This third hand base and arm has various uses. It may be used with a tungsten tip for soldering or a UV filter for eye protection. Individual parts must be ordered separately.

50-1028: An all *stainless steel third hand* with a weighted base and ball joint tungsten tips to position work at any angle.

ITEM #	DESCRIPTION
50-1021	THIRD HAND BASE AND ARM ONLY *
50-1022	TUNGSTEN TIP *
50-1028	THIRD HAND SS DOUBLE TUNGSTEN TIP-BAR TYPE
50-1029	THIRD HAND SS DOUBLE TUNGSTEN TIP-FLEX TYPE

* Tungsten tip is to be used with third hand base 50-1021

10. Third Hand Holders-Round Base

Useful accessory that positions work pieces during soldering. Select a complete unit or just the base or tweezers.

Double Clamp Stand: Heavy work base with universal adjustment. Hands hold parts in place to simplify soldering.

ITEM #	DESCRIPTION
50-1031	THIRD HAND W/TWEEZERS
50-1032	BASE ONLY
56-1253	CROSS LOCK TWEEZERS
50-1034	DOUBLE CLAMP STAND

11. GRS® Third Hand Soldering Stations

The ultimate work station for all your soldering applications. Mounted on a metal base with a replaceable non-asbestos working platform. Chose from two styles; single third hand or double third hands.

#004-570: Includes two removable standard third-hands and 6" square solder board. Sits on a bench or attaches to BenchMate.

#004-545: Includes two short third-hands and 6" square solder board.

#004-691: For platinum or other high-temp work; 6" square.

#004-097TUNG: For other high-temp work including platinum.

ITEM #	DESCRIPTION
50-1041	#004-568 THIRD HAND WEIGHTED BASE
50-1042	#004-570 DOUBLE THIRD HAND S/STATION
50-1043	#004-545 SHORT THIRD HAND S/STATION
50-1044	#004-689 SHORT THIRD HAND WEIGHTED BASE
50-1046	#004-130 EXTRA 4" SQUARE SOLDER BOARD
50-1047	#004-129 EXTRA 6" SQUARE SOLDER BOARD
50-1048	#004-691 HIGH-TEMPERATURE S/PLATFORM
50-1051	#004-097TUNG JAW POINT- TUNGSTEN *
50-1052	#004-097 JAW POINT- STANDARD *

*Always order two jaws

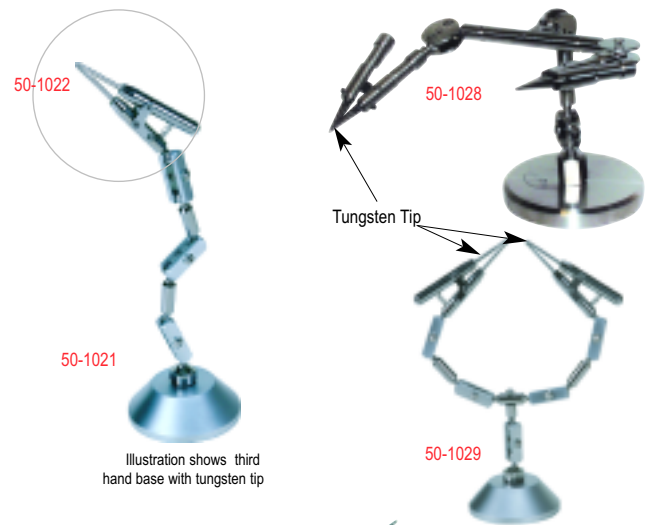

Illustration shows third hand base with tungsten tip





(Torch is not included)

12. Rotating Soldering Table with Third Hand

This rotating soldering table includes an added feature of two third hands for positioning of work pieces. Both third hands have tungsten tips. An accessory for holding the Little Torch is available. See page # 269. Table is 8½" in diameter.

ITEM #	DESCRIPTION
50-1066	S/BOARD WITH THIRD HAND
50-1067	SOLDERING BOARD ONLY

13. Rotating Soldering Table

Allows convenient positioning at any angle as the table revolves on ball bearings. Low height and special honeycomb design provides firm holding of small parts. 5½" diameter.

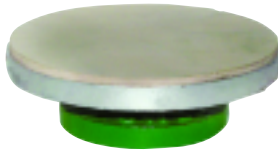

ITEM #	DESCRIPTION
50-1061	SOLDERING TABLE -COMPLETE
50-1062	REPLACEMENT LAVA DISC

14. Honeycomb Soldering Blocks

Most commonly used ceramic block, that has fine pores to accelerate the heat loss from parts being soldered. Holes may be used to retain fine wire articles or used as anchor points. Asbestos free, these blocks withstand temperatures up to 2000°F.

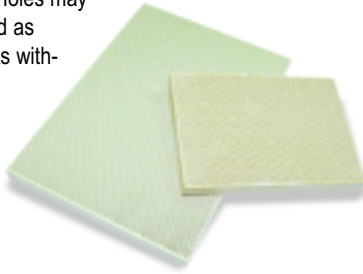

ITEM #	DIMENSIONS
50-1074	3¾" X 5½" X ½"
50-1075	5½" X 7¾" X ½"

15. Silquar Hi-Heat Boards

A non-asbestos soldering board. Withstands heat to a maximum temperature 2000°F/1093°C. Cleans easily with water.

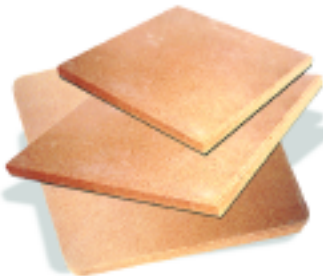

ITEM #	DIMENSIONS
50-1081	6" X 6" X ½"
50-1082	6" X 12" X ½"
50-1083	12" X 12" X ½"

16. Ceramic Soldering Blocks

Non-asbestos blocks, suitable to withstand high temperatures up to 2000°F/1093°C with little or no thermal expansion. A flat working surface that retains heat and cleans easily.



ITEM #	DIMENSIONS	TYPE
50-1071	6½" X 3" X 1"	OVAL
50-1072	4½" X 1"	ROUND

17. Soldering Boards for Platinum

Made of super refractory material, these boards meet the demand of high temperature soldering of platinum. Extremely low thermal conductivity without loss of strength, these boards are free of any metallic impurities.



ITEM #	DIMENSIONS
50-1086	4" X 4" X ½"
50-1087	6" X 6" X ½"
50-1088	5" X 5" X ½" -JAPAN

18. Solderite™ Boards- Asbestos Free

An entirely new material that is asbestos free, flame resistant and non-combustible. These boards have good heat reflection and insulating qualities. In addition, they will not flake or crumble, making it the best all purpose soldering board.



ITEM #	DIMENSIONS
50-1091	6" X 6" X ½"
50-1092	6" X 12" X ½"
50-1093	12" X 12" X ½"



19. Charcoal Block

Made from selected soft wood. Easy to pin or press work pieces while soldering. Creates a reducing atmosphere and reflects heat back on the article being soldered.

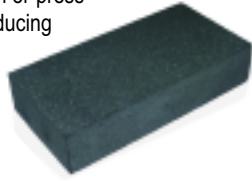

ITEM #	DIMENSIONS
50-1101	5 1/2" X 2 3/4" X 1 1/8"

20. Silica Soldering Board

A novel type of board that is soft and flexible, yet will not break if dropped. Useful to hold a variety of different articles. Withstands temperatures up to 2500°F.



ITEM #	DIMENSIONS
50-1117	6" X 6" X 1/2"

21. Picklers

Picklers provide a safe and effective method for removing oxides or fire scale from the surfaces of precious metals.

50-1131 / 50-1132: Includes an acid resistant retrieval basket.

Constant bath temperature at 140°F/60°C.

50-1136: A low cost pickle pot.



50-1131 / 50-1132



50-1136

ITEM #	DESCRIPTION
50-1131	IKOHE PICKLER- (14 OZ) 110V/60HZ
50-1132	IKOHE PICKLER - (14 OZ) 220V/ 50HZ
50-1136	LITTLE DIPPER PICKLER (16 OZ) -110V/60HZ
50-1137	PLASTIC BASKET FOR 50-1131

22. Copper Tongs

These tongs are suitable to use when immersing articles in pickling or acidic solutions. Will not contaminate or corrode the solutions. Overall length 9".



ITEM #	DESCRIPTION
50-1118	COPPER TONGS -BENT
50-1119	COPPER TONGS -FISH TAIL

23. Magnesia Block

An economical type block that is porous and fireproof. Lasts longer than charcoal blocks. Soft enough to enable work to be pressed into the surface and steadied while soldering.



ITEM #	DIMENSIONS
50-1122	6" X 3" X 1 1/2"

24. Thermic Isolator Grain

Granular, irregular shaped grains used to support work pieces during soldering. May be used wet or dry. Indispensable when soldering unusual shapes of jewelry items.



ITEM #	DESCRIPTION
50-1121	SOLDER GRAINS- 500G

25. SPAREX® Pickling Compound

Non-flammable, granular dry acid compound, for use in Picklers. Cleans and removes surface oxidation and fire scale discoloration, on gold, silver and non-ferrous alloys. Works efficiently at a constant temperature of 140°F/60°C.



ITEM #	DESCRIPTION
50-1141	COMPOUND 2 1/2" LB
50-1142	COMPOUND 10 OZ.
50-1143	COMPOUND 45 LB DRUM

26. Binding Wire-Iron

For binding various items together, may be used during soldering.



ITEM #	GAUGE	INCH	WEIGHT
50-1111	20	0.032	8 OZ
50-1112	22	0.025	8 OZ
50-1113	24	0.020	8 OZ
50-1114	26	0.016	8 OZ
50-1116	33	0.006	8 OZ



27. Tix Solder Products

Tix Solder: A specially prepared solder that adheres easily to all solderable materials. Melts at 275°F. It has extraordinary bonding strength, stays bright and will not tarnish. Package of 20 rods 3" length.

Tix Flux®: A liquid non-corrosive flux, harmless to hands or clothing. Compatible with most soft solders to increase fluidity. Washes away with water, even after drying.

Anti-Tix Flux®: A liquid mask that when brushed on will prevent solder flow to unwanted areas. May be used for hard or soft solders.



ITEM #	DESCRIPTION
50-1161	TIX SOLDER PK/20 RODS 3" L
50-1162	TIX FLUX- ½ OZ.
50-1163	ANTI-TIX FLUX- ½ OZ.

28. Batterns® Self Pickling Hard Soldering Flux

Makes hard soldering as easy as soft soldering. Holds solder bits in place and preserves the color and temper of the material. Use on gold, silver and platinum.



ITEM #	DESCRIPTION
50-1170	BATTERNS® S/FLUX - 8 OZ.
50-1171	BATTERNS® S/FLUX - 16 OZ.
50-1172	BATTERNS® S/FLUX - 32 OZ.

29. Stay Bright Soldering Kit

Slightly higher temperature bearing lead free solder, melts at 450°F. May be used with a soldering torch or gun. Use Stay Clean flux to achieve good flow characteristics. Kit includes ½ oz. of solder and ½ fl oz. of Stay Clean flux.



ITEM #	DESCRIPTION
50-1191	STAY BRIGHT KIT WITH FLUX
50-1192	STAY CLEAN FLUX ½ FL OZ.

30. Handy® Flux

An economical long lasting paste flux that sustains prolonged heating. Contains fluoride, potassium and hydroxides. Widely used by silversmiths for soldering gold, silver, brass and non-ferrous metals.



ITEM #	DESCRIPTION
50-1181	HANDY FLUX 8 OZ.
50-1182	HANDY FLUX 1 LB
50-1183	HANDY FLUX 5 LB

31. Dandix Paste Flux

A paste flux for low temperature soldering. Contains no fluoride and prevents discoloration or oxide buildup. Apply with a brush where needed to assist solder flow.



ITEM #	DESCRIPTION
50-1184	DANDIX PASTE 1½ OZ.
50-1185	DANDIX PASTE 8 OZ.
50-1186	DANDIX PASTE 16 OZ.

32. Cool Paste

Frequently used, non-toxic, non-asbestos paste for localized protection from heat damage during soldering and brazing. Effective up to 2000°F. Easily cleansed by water.



ITEM #	DESCRIPTION
50-1187	COOL PASTE - 4 OZ.

33. Cold Shield

A non-toxic, non-corrosive paste that protects stones, plastics, and precious metals from damage by heat while soldering or brazing. Withstands heat up to 3000°F. Cleans away easily with water.



ITEM #	DESCRIPTION
50-1188	COLD SHIELD 16 OZ. JAR
50-1189	COLD SHIELD 32 OZ. JAR



34. Flux Dispenser

Pump Dispenser: Durable plastic bottle. Dispenses a limited amount of flux into a reservoir.



Needle Tip Dispenser:

Eliminate the use of flux brushes by using this bottle dispenser. Spot dispensing puts the flux exactly where needed.

ITEM #	DESCRIPTION
50-1154	PUMP DISPENSER- 4 OZ
50-1155	NEEDLE TIP DISPENSER- 2 OZ

35. Yellow Ochre

Mix with water or alcohol and use as a paste to prevent the flow of solder to unwanted areas.



ITEM #	DESCRIPTION
50-1194	YELLOW OCHRE - 1/2 LB

36. Boric Acid Powder

Dissolve in denatured spirit, in a glass container, to make a liquid flux. Recommended for general soldering tasks. Keep covered as it evaporates easily.



ITEM #	DESCRIPTION
50-1198	1 1/2 LB JAR

37. Borax® Powder

Makes paste by the addition of water. When applied, acts as a flux and allows solder to flow. Best used to line the insides of crucibles, as it helps extend crucible life.



ITEM #	DESCRIPTION
50-1195	POWDER CONE
50-1196	BORAX 1 1/2 LB

38. Red Sable Brushes

Pure sable hair bristles, crimped in ferrules, mounted in a convenient sized pencil grip. Extremely fine points, in assorted sizes for art and design work. Size 3/0 is smallest and #2 is the largest.

Sold pk/12



ITEM #	DESCRIPTION	SIZE
24-1081	RED SABLE BRUSH	3/0
24-1082	RED SABLE BRUSH	2/0
24-1083	RED SABLE BRUSH	0
24-1084	RED SABLE BRUSH	1
24-1085	RED SABLE BRUSH	2



39. "Magic" Soldering Products

Magic Boric Acid Powder : High grade flux and deoxidizing agent. May be mixed with denatured alcohol to make a soldering flux.

50-2021 16 OZ.

Black Magic Non-Acid Pickle : Non acid soldering pickle. Will not be affected by steel tweezers. Comes in powder form. Just add water to use. Shipped in gallon container.

50-2024 16 OZ.

Magic Pickle: Dry granulated pickling compound for cleaning and removing oxidation and fire scale. Mix one tablespoon to one pint of water.

50-2027 16 OZ.

Magic Boric Soldering Dip: A ready to use water based compound. Articles are to be dipped prior to soldering.

50-2028 8 OZ.

Magic Flame: A multi purpose soldering compound. Add with equal parts of water to produce a gold or silver flux. May be used in paste form for a full strength flux.

50-2029 8 OZ.

Pure Magic Concentrate Powder: A powder concentrate to be mixed with water to make one quart. Dip articles in solution and torch clean before soldering.

50-2031 8 OZ.



40. Repair Solders - Cadmium Free

Solder in sheet form for the identical color match to the carat of the piece to be soldered. All free flowing to provide a strong permanent joint. Available in three grades. Sold one dwt (1.555g).



ITEM #	GRADE	MELTING TEMP °F
50-1206	6Y EASY	1345°F
50-1210	10Y EASY	1340°F
50-1211	10Y MEDIUM	1395°F
50-1212	10Y HARD	1475°F
50-1214	14Y EASY	1395°F
50-1215	14Y MEDIUM	1380°F
50-1216	14Y HARD	1471°F
50-1218	18Y EASY	1425°F
50-1219	18Y MEDIUM	1495°F
50-1220	18Y HARD	1535 °F
50-1250	10W EASY	1365°F
50-1251	10W MEDIUM	1425°F
50-1252	10W HARD	1550°F
50-1254	14W EASY	1380°F
50-1255	14W MEDIUM	1440°F
50-1256	14W HARD	1570°F
50-1258	18W EASY	1465°F
50-1259	18W MEDIUM	1495°F
50-1260	18W HARD	1590°F

41. Plumb Solders- Cadmium Free

High quality solders manufactured to stringent standards for uniformity and color. Guaranteed flow temperature for each grade. Available in three grades. Sold one dwt (1.555g).



ITEM #	GRADE	MELTING TEMP °F
50-1306	6KYP EASY	1350°F
50-1310	10KYP EASY	1375°F
50-1311	10KYP MEDIUM	1400°F
50-1312	10KYP HARD	1475°F
50-1314	14KYP EASY	1340°F
50-1315	14KYP MEDIUM	1390°F
50-1316	14KYP HARD	1480°F
50-1318	18KYP EASY	1430°F
50-1319	18KYP MEDIUM	1475°F
50-1320	18KYP HARD	1550°F
50-1350	10KWP EASY	1390°F
50-1351	10KWP MEDIUM	1435°F
50-1352	10KWP HARD	1570°F
50-1354	14KWP EASY	1390°F
50-1355	14KWP MEDIUM	1450°F
50-1356	14KWP HARD	1570°F
50-1358	18KWP EASY	1460°F
50-1359	18KWP HARD	1610°F

41-1252 Notching Plier-Strap/Solder : Ideal tool for notching solder sheets. Box joint, spring loaded with a comfortable grip. Overall length 5"/130mm. See page #317

44. Platinum Solders

A perfect solder for platinum to avoid problems of porosity and color match. Available in three different grades. Sold one dwt. sheet

ITEM #	GRADE	MELT. POINT °F
50-1501	PLAT1000	1000°
50-1502	PLAT1200	1200°
50-1503	PLAT1500	1500°
50-1504	PLAT1700	1700°
50-1505	PLAT1750	1750°

45. Silver Solders- Sheet -30ga

Manufactured to exacting standards with consistency of melting and flow point. Available in three grades. Sold ¼ troy oz. sheet

ITEM #	GRADE	MELT. POINT °F
50-1510	SILVER EASY	1325°
50-1512	SILVER MEDIUM	1360°
50-1514	SILVER HARD	1450°

42. Solder Paste- Cadmium Free

Ready to use, pre-mixed alloy and flux in a dispensing syringe. Eliminates waste by spot application. Select from color matches with the base material to give a professional appearance. Silver solders are cadmium free. Gold solders are plumb and contain 1 dwt. gold per 1 cc. syringe.



ITEM #	GRADE	MELTING TEMP °F
50-1410	YELLOW 10K SOFT	
50-1414	YELLOW 14K HARD	
50-1415	YELLOW 14K MEDIUM	
50-1416	YELLOW 14K SOFT	
50-1418	YELLOW 18K SOFT	
50-1454	WHITE 14K HARD	
50-1455	WHITE 14K SOFT	
50-1465	WHITE SILVER HARD	
50-1466	WHITE SILVER SOFT	
50-1471	SILVER EASY	1325°F
50-1472	SILVER MEDIUM	1360°F
50-1473	SILVER HARD	1450°F

43. Firescoff™ Flux Heat Shield

Firescoff™ is an award winning spray ceramic coating that prevents oxidation and scale, acts as a flux, and features easy removal with just warm water. No paste or liquid flux is required, no pickle solution is needed. Perform multiple soldering operations without waiting. Coating can be applied and used later. Fluoride-free, odorless, alcohol-free, and non flammable.



ITEM #	CAPACITY
50-1521	30ML
50-1522	125ML



STAMPING

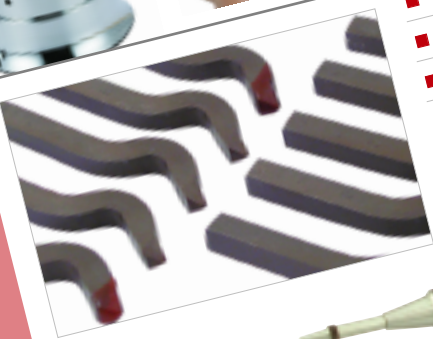

■ Automatic Center Punches	277
■ Hand Stamp Sets	278
■ Marking Plier	278
■ Marking Plier Stamps	276
■ Precision Hand Stamps-USA	277
■ Ring Stamping Device	278
■ Ring Stamping Machine	277
■ Ring Stamps- Imported	277
■ Stamp Sets- Imported	276
■ Stamping Anvil	276



The Complete Metalsmith

by **Tim McCreight**

A handy bench reference that clearly explains shaping, forging, raising, mechanisms, casting and reticulation. This easy-to-use book describes everything from the use of tools to metals and their properties.

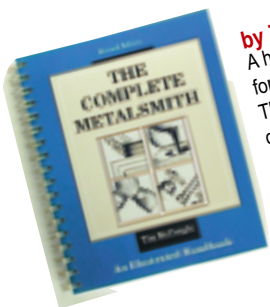

61-1071 (Spiralbound – 150 pages)



1. Precision Hand Stamps-USA

Steel stamps, precision cut, available in two sizes. Stamps are square body.

Size #2=($\frac{1}{32}$ " , 0.8mm), **Size#3**=($\frac{1}{45}$ " , 0.6mm).

These stamps may be used on a stamping machine.

Precision Hand Stamp Sets - Bent

10 pcs set includes numerals 0-9

27 pcs set includes the alphabets A-Z and a period.



ITEM #	DESCRIPTION
51-1381	10 PCS SET #3 (0-9)
51-1382	10 PCS SET #2 (0-9)
51-1383	27 PCS SET #2 (A-Z)
51-1384	27 PCS SET #3 (A-Z)

Precision Hand Stamp Sets - Straight

10 pcs set includes numerals 0-9

27 pcs set includes the alphabets A-Z and a period.



ITEM #	DESCRIPTION
51-1386	10 PCS SET #2 (0-9)
51-1387	10 PCS SET #3 (0-9)
51-1388	27 PCS SET #2 (A-Z)
51-1389	27 PCS SET #3 (A-Z)

For custom orders of stamps and logos please specify the following:

- Type of stamp (straight, bent or plier)
- Letter height and style
- Art work of your logo



Precision Hand Stamp -USA

Steel stamps, precision cut, available in two sizes. **Sold each.**

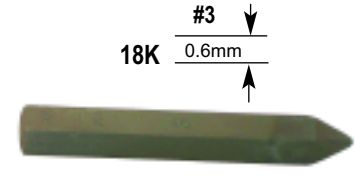
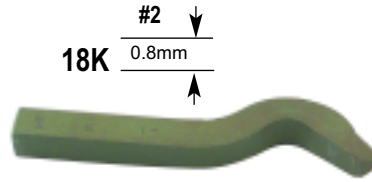

#	BENT	
	#2	#3
9K	51-1009	51-1109
10K	51-1010	51-1110
12K	51-1012	51-1112
14K	51-1014	51-1114
14KP	51-1015	51-1115
18K	51-1018	51-1118
21K	51-1021	51-1121
22K	51-1022	51-1122
24K	51-1024	51-1124
999	51-1025	51-1125
©	51-1026	51-1126
9999	51-1031	51-1131
PLAT	51-1032	51-1132
STER	51-1033	51-1133
STERLING	51-1041	51-1141
PLATINUM	51-1042	51-1142
417	51-1051	51-1151
585	51-1052	51-1152
750	51-1053	51-1153
875	51-1054	51-1154
916	51-1055	51-1155
921	51-1056	51-1156
925	51-1057	51-1157
950	51-1058	51-1158
SS	51-1059	51-1159
SIL	51-1060	51-1160
9CT	51-1061	51-1161
10CT	51-1062	51-1162
14CT	51-1063	51-1163
18CT	51-1064	51-1164
22CT	51-1065	51-1165

#	STRAIGHT	
	#2	#3
9K	51-1209	51-1309
10K	51-1210	51-1310
12K	51-1212	51-1312
14K	51-1214	51-1314
14KP	51-1215	51-1315
18K	51-1218	51-1318
21K	51-1221	51-1321
22K	51-1222	51-1322
24K	51-1224	51-1324
999	51-1225	51-1325
©	51-1226	51-1326
9999	51-1231	51-1331
PLAT	51-1232	51-1332
STER	51-1233	51-1333
STERLING	51-1241	51-1341
PLATINUM	51-1242	51-1342
417	51-1251	51-1351
585	51-1252	51-1352
750	51-1253	51-1353
875	51-1254	51-1354
916	51-1255	51-1355
921	51-1256	51-1356
925	51-1257	51-1357
950	51-1258	51-1358
SS	51-1259	51-1359
SIL	51-1260	51-1360
9CT	51-1261	51-1361
10CT	51-1262	51-1362
14CT	51-1263	51-1363
18CT	51-1264	51-1364
22CT	51-1265	51-1365

2. Stamping Anvil

This brass anvil positions ring bands in the cavity during stamping. Grooves are designed for different ring sizes. On the combo, one side is for ladies rings and the other side is for men's rings.

ITEM #	DESCRIPTION
51-1391	MALE
51-1392	FEMALE
51-1393	COMBO



3. Stamp Sets- Imported

Steel stamp sets for manual marking. Individual sets for alphabets and numerals. In the numeral set #6 is also used as #9.

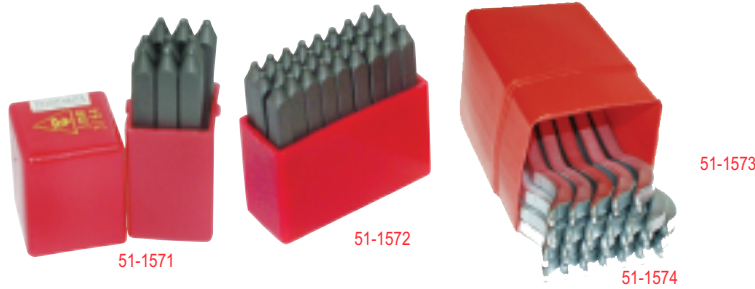

ITEM #	DESCRIPTION
51-1571	SET OF 9 PCS (0-9)-STRAIGHT
51-1572	SET OF 27 PCS (A-Z)-STRAIGHT
51-1573	SET OF 9 PCS (0-9)-BENT
51-1574	SET OF 27 PCS (A-Z)-BENT

4. Hand Stamp Sets

Steel stamp sets for impression marking on metal surfaces. Character height $\frac{1}{16}$ ". Alphabet set has letters A-Z one each, and period. Numeral set has 0-9 - #6 is used as #9. Sets are organized on a hardwood stand.



ITEM #	DESCRIPTION
51-1577	STAMP SET OF 9 PCS(0-9)
51-1578	STAMP SET OF 27 PCS(A-Z)

5. Ring Stamping Device

Standard square body stamps may be used on the machine to eliminate holding of the ring by one hand and stamping with the other. Ring may be positioned in the soft nylon anvil to eliminate mars on the surface. Flat stamping can also be done by use of a flat anvil. Stamps must be ordered separately.

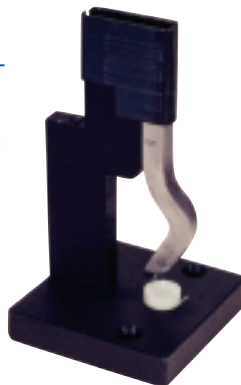

ITEM #	DESCRIPTION
51-1397	RING STAMPING DEVICE

6. Ring Stamps- Imported

High quality steel square body stamps, used to stamp impressions on metal surfaces. Very clear and precise marking on the inside of rings.

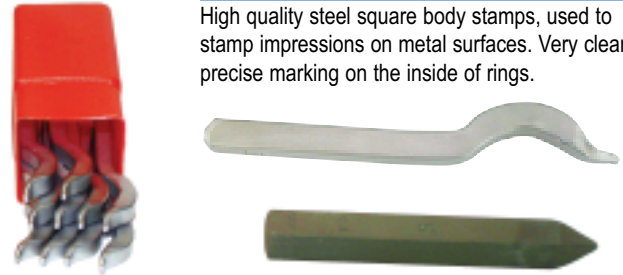

#	1MM
	BENT
9K	51-1709
10K	51-1710
12K	51-1712
14K	51-1714
18K	51-1718
21K	51-1721
22K	51-1722
24K	51-1724
99.99	51-1725
©	51-1726
STERLING	51-1741
PLATINUM	51-1742
PT	51-1751
585	51-1752
750	51-1753
875	51-1754
916	51-1755
921	51-1756
925	51-1757
950	51-1758
SS	51-1759

#	1MM
	STRAIGHT
9K	51-1809
10K	51-1810
12K	51-1812
14K	51-1814
18K	51-1818
21K	51-1821
22K	51-1822
24K	51-1824
99.99	51-1825
©	51-1826
STERLING	51-1841
PLATINUM	51-1842
PT	51-1851
585	51-1852
750	51-1853
875	51-1854
916	51-1855
921	51-1856
925	51-1857
950	51-1858
SS	51-1859

7. Automatic Center Punches

Mark all metals without using a hammer. This compact tool delivers pin point impressions with a simple depression of the hand. The impression depth may be varied by adjusting the knurled screw head.

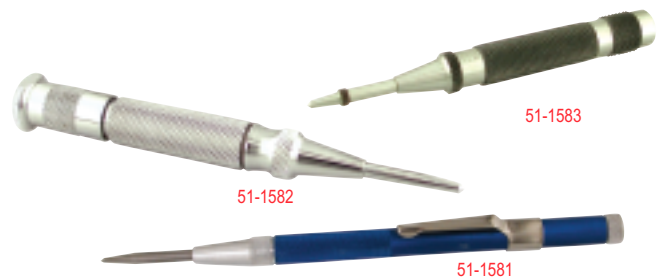

ITEM #	DESCRIPTION
51-1581	CENTER PUNCH & SCRIBER
51-1582	CENTER PUNCH-GERMAN
51-1583	CENTER PUNCH STARRETT®-USA



8. Ring Stamping Device

- Hammer includes both hard and soft head surfaces
- Stable base construction
- Conveniently stamp any style of ring
- Six stamps include (10k, 14k, 18k, PLAT, STER and SS)

ITEM #	DESCRIPTION
51-1401	INSIDE RING STAMPING DEVICE-MANUAL
51-1402	INSIDE RING STAMPING DEVICE GEAR TYPE
51-1405	RING STAMP- 10K
51-1406	RING STAMP- 14K
51-1407	RING STAMP- 18K
51-1408	RING STAMP- PLAT
51-1409	RING STAMP- STER
51-1410	RING STAMP- SS
43-1061	RING MATE- HAMMER

9. Marking Plier

Durable stainless steel ring marking plier to stamp the inside of rings. Different stamps can be locked in position by a set screw. Use on flat or curved surfaces by fitting the respective anvil. Individual stamps are available separately. Overall length 5 1/2" long.

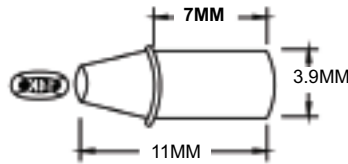

ITEM #	DESCRIPTION
41-1341	MARKING PLIER ONLY
41-1342	MARKING PLIER BOX ONLY
41-1343	FLAT & CURVED ANVIL
41-1344	PLIER WITH 3 STAMPS (10, 14, 18K)

10. Marking Plier Stamps

Quality steel stamps with round shanks. Suitable for use in the marking plier.

Sold each

#	ITEM #
9K	51-1609
10K	51-1610
12K	51-1612
14K	51-1614
14KP	51-1615
18K	51-1618
20K	51-1620
21K	51-1621
22K	51-1622
24K	51-1624
999	51-1631
9999	51-1632
©	51-1633
STERLING	51-1641
PLATINUM	51-1642
PLAT	51-1651
STER	51-1652

#	ITEM #
417	51-1661
585	51-1662
750	51-1663
875	51-1664
916	51-1665
921	51-1666
925	51-1667
950	51-1668
SS	51-1669
9CT	51-1670
10CT	51-1671
22CT	51-1672
SIL	51-1673

For custom orders of stamps and logos please specify the following:

- Type of stamp (straight, bent or plier)
- Letter height and style
- Art work of your logo

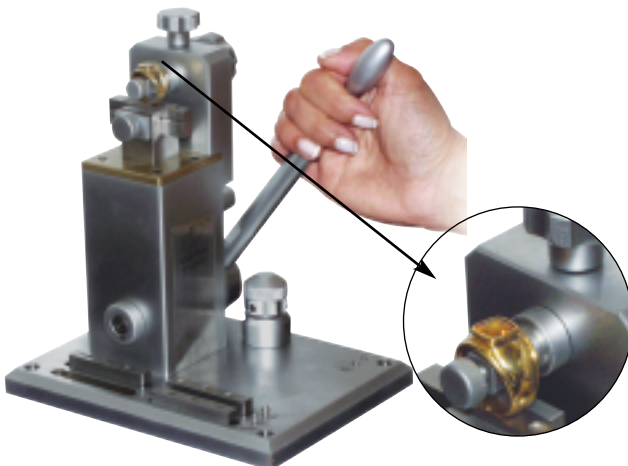

11. Ring Stamping Machine

A new cam operated stamping machine that lets you accomplish precision marking on the inside of all ladies and gents rings. Rings are positioned precisely in non marring jigs and impressions can be controlled with a smooth acting hand lever. Additional jig converts for flat surface marking as well. Clear top view technique allows you to mark with ease and confidence.

ITEM #	DESCRIPTION
51-1675	RING STAMPING MACHINE
51-1677	RING STAMPING ANVIL -4 PC SET



SURFACE FINISHING

750- Compound	287
910- Compound	287
920- Compound	287
Blasting Media	287
Burnishing Compound	285
Ceramic Media	287
Detergent Compounds	286
Dri-Shine	281
Eco-Maxi Disc Finisher	281
Eco-Mini Disc Finisher- "Dry"	281
Eco-Mini Disc Finisher- "Wet"	281
EZ View Sandblasters	288
Flow Thru System	284
Gems Rotary Tumbler	280
Magnetic Finishers	286
Magnetic Separators	283
Mini Magnetic Finishers	288
Mini Sand Blaster	283
Mini Vibratory Tumbler	288
Pen Style Sand Blaster	285
Plastic Media	286
Porcelain Balls	284
Rotary Tumbler	286
S/Steel Magnetic Pins & Balls	286



Sand Blaster	288
Steel Shot & Stainless Steel Shot	285
Steel Shot- Balls	286
Ultra Liquid Burnishing Compound	287
Vibratory Tumbler	283
Vibratory Tumbler TV/AV	282
Walnut Shell	286

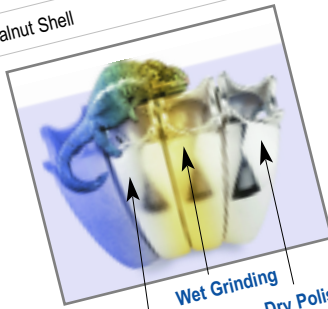

Magnetic Polishing

Wet Grinding

Dry Polishing

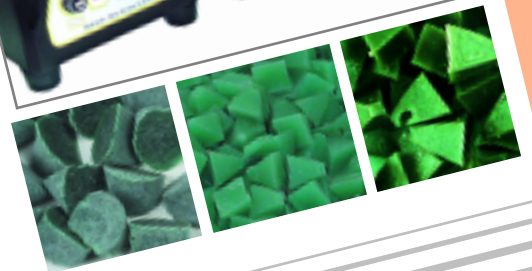

The Complete Metalsmith

by **Tim McCreight**

A handy bench reference that clearly explains shaping, forging, raising, mechanisms, casting and reticulation. This easy-to-use book describes everything from the use of tools to metals and their properties.

61-1071 (Spiralbound – 150 pages)

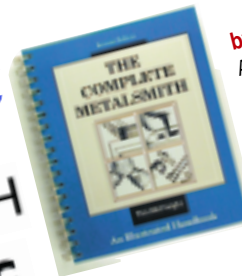



1. Magnetic Finishers

Easily surpasses vibratory or centrifugal systems. Engineered from the finest materials, it is tough, sturdy and dependable. Part, size or shape are not a concern. A choice of different polishing media gives you the option for controlling the surface finish, be it satin or ultra bright. All models have see through bowls with fill line indication and a cover.



Burnishing Additive
Available in 8 oz. bottle
see page 287

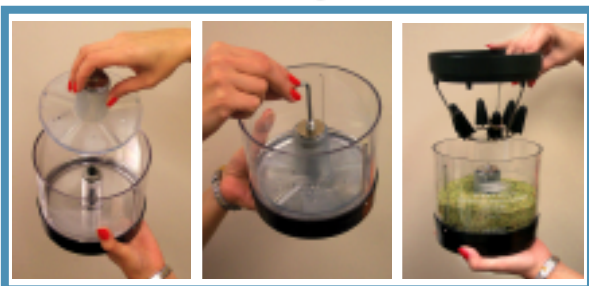

Use wet media for pre-polish and dry media for a luster finish.

Features:

- A direct drive, fan cooled motor for quiet operation
- On/off switch and pilot light
- Programmable models allow you to do multiple runs, plan new parameters, or even make last minute changes
- An end of cycle buzzer alerts you at the pre-set time

4" / 100 mm ø Magnetic Finisher

Manual System. Fixed speed. Mechanical timer. 100g of 0.5mm pins included. Dimensions: 6 $\frac{3}{4}$ " x 6 $\frac{3}{4}$ " x 11" Wt. 17 lbs

12 RING | 100G PIN CAPACITY

52-1011	MANUAL SYSTEM 110V / 60 HZ / 30 W
52-1012	MANUAL SYSTEM 220V / 50 HZ / 30 W
52-1015	4" BOWL REGULAR
52-1016	4" BOWL DRY - OPTIONAL
52-1017	4" BOWL WET - OPTIONAL
52-1018	RING FIXTURE FOR 4" BOWL

6" / 150 mm ø Magnetic Finisher

Digital System. Variable speed. Programmable for forward/reverse motion. 100g of 0.5mm pins included. Dimensions: 10" x 10" x 14" Wt. 20 lbs

30 RING | 200G PIN CAPACITY

52-1021	DIGITAL SYSTEM 110V / 60 HZ / 75W
52-1022	DIGITAL SYSTEM 220V / 50 HZ / 75W
52-1025	6" BOWL REGULAR
52-1026	6" BOWL DRY - OPTIONAL
52-1027	6" BOWL WET - OPTIONAL
52-1028	RING FIXTURE FOR 6" BOWL

9" / 230 mm ø Magnetic Finisher

Digital System. Variable speed. Programmable for forward/reverse motion. Pin capacity 500g (not included). Dimensions: 16" x 14" x 23" Wt. 55 lbs

100 RING | 500G PIN CAPACITY

52-1031	DIGITAL SYSTEM 110V / 60 HZ
52-1032	DIGITAL SYSTEM 220V / 50 HZ
52-1035	9" BOWL REGULAR

12" / 300 mm ø Magnetic Finisher

Digital System. Variable speed. Programmable for forward/reverse motion. Pin capacity 1 kg (not included) Dimensions: 16" x 16" x 26" Wt. 86 lbs

225 RING | 1 KG PIN CAPACITY

52-1041	DIGITAL SYSTEM 110V / 60 HZ
52-1042	DIGITAL SYSTEM 220V / 50 HZ
52-1045	12" BOWL REGULAR

Wet and Dry bowls must not be used with stainless steel pins. See pg# 286

Spare parts and accessories are available



SURFACE FINISHING

2. Eco-Mini Disc Finisher- "Dry"

The Eco Mini Dry finisher is capable of imparting an ultra shine to all precious metals including platinum. May also be used to restore the shine to hand finished or tarnished jewelry. Walnut media impregnated with polishing paste is the processing agent.

Specifications:

- 3L capacity • Power 50 w
- Dimensions: 220 Ø X 330 MM Ht. • Weight 8 lbs.

Unit Includes :

- 12 hour timer
- Walnut media - Coarse (1 kg)
- Walnut media- fine (1 kg)
- Polishing paste P6 - 200g



ITEM #	DESCRIPTION
52-1051	ECO MINI DRY 110V / 60 HZ -3L
52-1052	ECO MINI DRY 220V / 50 HZ -3L
52-1055	WALNUT MEDIA H ₁₀₀ COARSE-1 KG
52-1056	WALNUT MEDIA H ₅₀₀ FINE-1 KG
52-1057	POLISHING PASTE TYPE P6 -110G

3. Eco-Mini Disc Finisher- "Wet"

The Eco Mini Wet finisher is designed for wet grinding of rough unprocessed cast jewelry. Plastic grinding media is used as the processing agent. In addition the continuous through flow of water washes out the loose abrasives to generate a pre-polishing surface capable of imparting an ultra shine to all precious metals including platinum.

Specifications:

- 3L capacity • Power 80 w
- Dimensions: 220 Ø X 350 MM Ht. • Weight 14 lbs.

Unit Includes :

- 12 hour timer
- Plastic media (2.5 kg)
- Burnishing Compound (1 Lt.)
- Pump and Tank



ITEM #	DESCRIPTION
52-1061	ECO MINI WET 110V / 60 HZ -3L
52-1062	ECO MINI WET 220V / 50 HZ -3L
52-1064	PLASTIC MEDIA WHITE PX10-2 KG
52-1065	PLASTIC MEDIA WHITE KX10-2 KG
52-1066	BURNISHING COMPOUND-SC13 1 LT.

4. Eco-Maxi Disc Finisher

The Eco-Maxi disc finishing system is a modular unit that offers maximum flexibility. One fully equipped base powers three different processing bowls, thereby making the machine adaptable to every application- magnetic polishing, wet grinding and dry polishing. Achieve perfect results faster, without time-consuming hand finishing.

BOWL SPECIFICATIONS	UNIT INCLUDES	MEDIA CAPACITY
Dry Bowl- 6 lt. Part cap. 200g	—	2.2kg Walnut media (sold separately)
Wet Bowl- 6 lt. Part cap. 300g	Dosing pump, 200g SS pin, Compound SC4 1Lt.	3 kg Plastic media (sold separately)
Magnetic Bowl-6 lt. Part cap. 300g	160g SS shot	160g SS shot (sold separately)

Note: Eco-Maxi base unit, process bowl and media are sold separately.

ITEM #	DESCRIPTION
52-1071	ECO MAXI BASE UNIT 110V / 60 HZ
52-1072	ECO MAXI BASE UNIT 220V / 50 HZ
52-1075	ECO MAXI -MAGNETIC BOWL - 6 LT.
52-1076	ECO MAXI -WET BOWL -110V - 6 LT.
52-1077	ECO MAXI -WET BOWL - 220V - 6 LT.
52-1078	ECO MAXI -DRY BOWL - 6 LT.

Wet / Dry Unit Features:

- Timer
- Variable speed control
- Quick release
- Includes dosing pump and container
- Inner Ø 9"
- Wt: 11 lbs Wet Bowl
- Wt: 5 lbs Dry Bowl

Magnetic Unit Features:

- Timer
- Variable speed control
- Auto left-right directional change
- Inner Ø 9"
- Wt: 10 lbs

Base Unit Features:

- LC- Display for speed/time
- Variable speed control
- Quick release
- Automatic bowl recognition
- Auto left-right directional change
- Dimensions: 15" X 12" X 20"
- Wt: 55 lbs

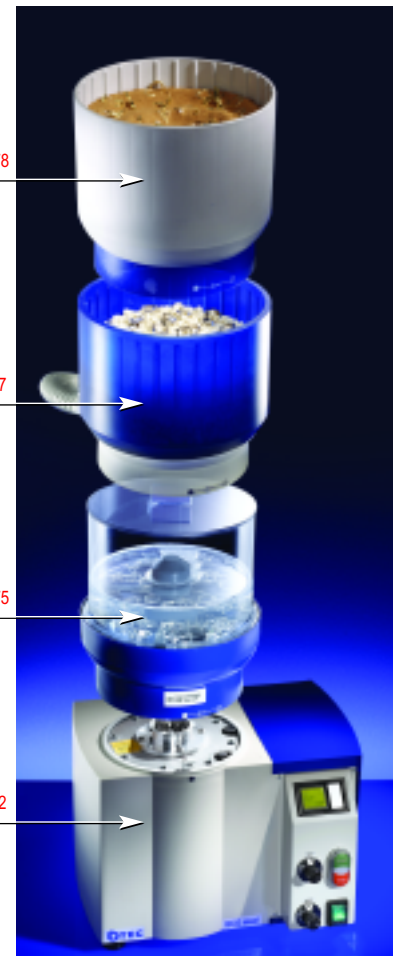



5. Tumble- Vibe 5

- A light duty tumbler, with a pre-set amplitude
- Workpiece capacity 25 rings with media
- Bowl diameter 8" (0.5 cu.ft)
- **Cannot be used with a flow through (FT).**
- Media :
 - » Ceramic 5 lbs
 - » Plastic 3 lbs
 - » Dry Shine 1 lb

Wt. 6 lbs
CE approved.



ITEM #	DESCRIPTION
52-1101	TV-5 110V / 60HZ
52-1102	TV-5 220V / 50HZ
52-1105	SPARE BOWL & LID 23-005

6. Tumble- Vibe 10

- Industrial duty tumbler with a tough polyethylene bowl
- Workpiece capacity 50 rings with media
- Bowl diameter 10" (0.1 cu.ft.)
- **Can be used with a flow through (FT-20)**
- Media :
 - » Ceramic 9 lbs
 - » Plastic 6 lbs
 - » Dry Shine 2 lbs

Do not run steel shot in this machine. Doing so will void the warranty.

Wt. 12 lbs
CE approved.



ITEM #	DESCRIPTION
52-1111	TV-10 110V / 60HZ
52-1112	TV-10 220V / 50HZ
52-1115	SPARE BOWL & LID 23-010

Media capacities shown are approximate. The total media capacity and the actual media amounts will vary in direct proportion to the amount of parts being tumbled.

7. Adjusta- Vibe 18

- Industrial duty tumbler for use with all types of media
- Vibratory amplitude can be adjusted
- Equipped with drain
- Process metal parts for deburring or polishing
- Bowl diameter 12" (0.18 cu.ft.)
- **Can be used with a flow through (FT-20)**
- Media :
 - » Ceramic 32 lbs
 - » Plastic 20 lbs
 - » Dry Shine 11 lbs

Wt. 13 lbs
CE approved.



ITEM #	DESCRIPTION
52-1121	AV-18 110V / 60HZ
52-1122	AV-18 220V / 50HZ
52-1125	SPARE BOWL & LID 23-036

8. Adjusta-Vibe 25SS

- Designed with a heavy duty drive and suspension system
- Specifically for use with steel and stainless steel media
- Bowl has a discharge port for easier unloading
- Workpiece capacity 125 rings with media
- Bowl diameter 14" (0.22 cu.ft.)
- **Can be used with a flow through (FT-20)**
- Media :
 - » Ceramic 20 lbs
 - » Plastic 13 lbs
 - » Dry Shine 7 lbs
 - » **Steel Shot 50 lbs**

Wt. 22 lbs
CE approved.



ITEM #	DESCRIPTION
52-1131	AV-25SS 110V / 60HZ
52-1132	AV-25SS 220V / 50HZ
52-1135	SPARE BOWL & LID 23-018

9. Adjusta-Vibe 40

- Compact unit with adjustable amplitude
- Heavy duty cross-linked polyethylene bowl
- Includes inlet and outlet ports for compound rinsing
- Noise reducing lid is standard with the machine
- Workpiece capacity 125 rings with media
- Bowl diameter 17" (0.35 cu.ft.)
- **Can be used with a flow through (FT-75)**
- Media :
 - » Ceramic 32 lbs
 - » Plastic 20 lbs
 - » Dry Shine 11 lbs

When steel burnishing is required use model 40ss

Wt. 51 lbs
CE approved.



ITEM #	DESCRIPTION
52-1141	AV-40 110V / 60HZ
52-1142	AV-40 220V / 50HZ
52-1145	SPARE BOWL & LID 23-032

10. Adjusta-Vibe 40SS

- Compact unit with adjustable amplitude
- Designed for use with steel or stainless steel media
- Includes inlet and outlet ports for compound rinsing
- Noise reducing lid is standard with the machine
- Workpiece capacity 125 rings with media
- Bowl diameter 17" (0.35 cu.ft.)
- **Can be used with a flow through (FT-75)**
- Media :
 - » Ceramic 32 lbs
 - » Plastic 20 lbs
 - » Dry Shine 11 lbs
 - » **Steel Shot 100 lbs**

Wt. 51 lbs
CE approved.



ITEM #	DESCRIPTION
52-1151	AV-40SS 110V / 60HZ
52-1152	AV-40SS 220V / 50HZ
52-1155	SPARE BOWL & LID 23-045



SURFACE FINISHING

11. Adjusta-Vibe 75

- Machine equipped with a heavy duty drive system
- Vibratory amplitude can be adjusted
- Noise reducing lid is standard with the machine
- Workpiece capacity 350 rings with media
- Bowl diameter 21" (0.75 cu.ft.)
- **Can be used with a flow through (FT-75)**
- Media : » Ceramic 72 lbs
- » Plastic 44 lbs
- » Dry Shine 24 lbs

Wt. 61 lbs
CE approved.



ITEM #	DESCRIPTION
52-1161	AV-75 110V / 60HZ
52-1162	AV-75 220V / 50HZ
52-1165	SPARE BOWL & LID 23-046

Tumble-Dump™ TD-40, TD-75

For fast easy unloading, the best choice would be Tumble-Dump models. Ask for details.

12. Ultra-Vibe Tumbler

- Heavy duty Polyethylene Bowl with lid.
- Vibrates at 3000 VPM
- Ball bearing motor with overload protection

Ultra Vibe 10

- Max. Load 10 lbs (including media)
- Dimensions: 10" Ø x 11" ht.
- Wt. 11 lbs

Ultra Vibe 18

- Max. Load 18 lbs (including media)
- Dimensions: 12" Ø x 13" ht.
- Wt. 11 lbs

Ultra Vibe 45

- Max. Load 52 lbs (including media)
- Dimensions: 17" Ø x 18" ht.
- Wt. 26 lbs



May be used with all type of media except steel shots.

ITEM #	DESCRIPTION
52-1181	ULTRA VIBE 10 110V / 60HZ 3 QT.
52-1182	ULTRA VIBE 10 220V / 50HZ 3 QT.
52-1185	ULTRA VIBE 18 110V / 60HZ 1½ GAL.
52-1186	ULTRA VIBE 18 220V / 50HZ 1½ GAL.
52-1188	ULTRA VIBE 45 110V / 60HZ 4¾ GAL.
52-1189	ULTRA VIBE 45 220V / 50HZ 4¾ GAL.

Ultra Vibe 18- Flow Thru

- Dimensions: 12" Ø x 13" ht. • Capacity 1½ gal. • Wt.18 lbs

Ultra Vibe 45- Flow Thru

- Dimensions: 17" Ø x 18" ht. Capacity 4¾ gal. • Wt.32 lbs

52-1191	ULTRA VIBE 18 110V / 60HZ FT.
52-1192	ULTRA VIBE 18 220V / 50HZ FT.
52-1195	ULTRA VIBE 45 110V / 60HZ FT.

For Tumbling Media see page # 285-286

13. Mini Vibratory Tumbler

A top quality machine with innovative features for finishing small batches of parts. Perfect for deburring, smoothing and pre-polishing of jewelry. Easy to setup and maintain. Best suited for small batches of up to 8 rings. Bowl is an integral unit and has the desired resilience for maximum vibration.

Uses 2 lbs of mix steel shot media (not included).

Features:

- Timer in steps of 15 mins-max. 75min.
- Variable speed control
- Fixed amplitude vibration

Specifications:

- Bowl 4.5"d. x 5.5"ht.
- Dimensions: 5" X 6.5" X 11.5"
- Wt: 7.5 lbs



ITEM #	DESCRIPTION
52-1211	MINI VT- 110V / 60HZ
52-1212	MINI VT- 220V / 50HZ

14. Mini Magnetic Finisher

A compact mini finisher that is ideal for finishing small batches of articles. Use it to burnish and pre-polish intricate designed jewelry.

Simple to operate. Just fill the bowl with media and jewelry items, set the speed and timer. Bowl capacity is for 6 rings.

Use 50g SS pin media (not included).

Features:

- Timer in steps of 15 mins-max. 75min.
- Variable speed control
- End of cycle as audible signal
- Includes two bowls (wet and regular)

Specifications:

- Bowl 4.5"d. x 5.5"ht.
- Dimensions: 5" X 6.5" X 11.5"
- Wt: 6.5 lbs

ITEM #	DESCRIPTION
52-1001	MAGNETIC FINISHER 110V / 60HZ
52-1002	MAGNETIC FINISHER 220V / 50HZ
52-1004	REPLACEMENT BOWL -REGULAR
52-1005	REPLACEMENT BOWL -WET



Flow Thru Systems for Vibratory Tumbler

FT-20 for TV-10 & TV-18 :

- An integrated system for automatic liquid flow
- Keeps the media and parts cool and lubricated
- Control panel has 0-6 hour timer

FT-75 for TD-75, AV-25SS, AV-40SS, AV-40 & AV-75

- A flow thru design for compound rinsing
 - Keeps the media and parts cool and lubricated
 - Allows metering of the solution up to 8 hours
- Please ask for details.





15. Rotary Tumbler- Programmable

Rotary Tumblers are stable well balanced units that are capable of processing larger work pieces with heavier media. Process times are longer than vibratory finishing, but a distinct advantage is that the surface of work pieces get work hardened. Barrels are multi sided, made of tough polycarbonate, are leak proof and will not corrode or rust. Use with all types of media including steel shot. Addition of burnishing compound and detergent keeps parts cool and avoids drag during tumbling. Features include variable speed, a programmable timer, forward/reverse and auto shut off with buzzer.



Recommendation:
For optimum performance fill the bowl to 50% of its capacity (parts and media)

Burnishing Additive
Available in 8 oz. bottle see page 287

Rotary Tumbler- 1 Lt.

Dimensions: 6 $\frac{3}{4}$ " x 6 $\frac{3}{4}$ " x 11" Wt. 17 lbs

5 $\frac{1}{2}$ " X 4" BOWL Ø DIGITAL TIMER 1 L VARIABLE SPEED
52-1221 110V / 60 HZ
52-1222 220V / 50 HZ
52-1225 REPLACEMENT BARREL FOR 1 L

Rotary Tumbler- 2 Lt. - DIRECT DRIVE

Dimensions: 10" x 10" x 14" Wt. 20 lbs

7 $\frac{1}{2}$ " X 5 $\frac{1}{2}$ " BOWL Ø DIGITAL TIMER 2 L VARIABLE SPEED
52-1231 110V / 60 HZ
52-1232 220V / 50 HZ
52-1235 REPLACEMENT BARREL FOR 2 L

Rotary Tumbler- 7 Lt. - DIRECT DRIVE

Dimensions: 10" x 14" x 17" Wt. 28 lbs

11 $\frac{1}{2}$ " X 4 $\frac{1}{2}$ " BOWL Ø DIGITAL TIMER 7 L VARIABLE SPEED
52-1241 110V / 60 HZ
52-1242 220V / 50 HZ
52-1245 REPLACEMENT BARREL FOR 7 L

16. Gems Rotary Tumbler

All steel construction, hexagonal rubber lined barrel with a leak proof cover. Belt driven by a continuous fan cooled motor. All rotating parts have permanently lubricated non-metallic bearings for efficient and quiet operation. Machine is complete with motor overload protection. All types of media including steel shot may be used. Slight wetting of burnishing media with detergent is recommended.

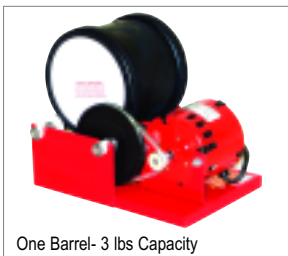

One Barrel- 3 lbs Capacity

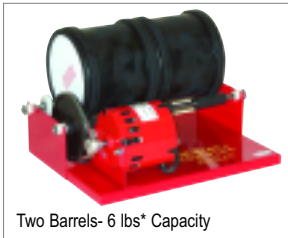

Two Barrels- 6 lbs* Capacity



Heavy-Duty- 15 lbs Capacity

One Barrel- 3 lbs Capacity Dimensions: 8 $\frac{1}{2}$ " X 6" X 9" Wt. 6 lbs

ITEM #	DESCRIPTION
52-1251	ONE BARREL - 110V / 60 HZ
52-1252	ONE BARREL - 220V / 50 HZ
52-1255	REPLACEMENT BARREL FOR 52-1251/1252

Two Barrels- 6 lbs* Capacity Dimensions: 11 $\frac{1}{2}$ " X 9" X 11" Wt. 9 lbs
*Each Barrel is 3 lbs capacity

ITEM #	DESCRIPTION
52-1261	TWO BARRELS -110V / 60 HZ
52-1262	TWO BARRELS -220V / 50 HZ
52-1255	REPLACEMENT BARREL FOR 52-1261/1262

Heavy-Duty- 15 lbs Capacity Dimensions: 14" X 12" X 14 $\frac{1}{2}$ " Wt. 18 lbs

ITEM #	DESCRIPTION
52-1271	HEAVY DUTY-110V / 60 HZ
52-1272	HEAVY DUTY- 220V / 50 HZ
52-1275	REPLACEMENT BARREL FOR 52-1271

* Replacement parts are available on order.



SURFACE FINISHING

17. Steel Shot & Stainless Steel Shot

Steel Shot (C.S): Made of carbon steel in various shapes, but uniform in size. Fine shot is the ideal choice of media for burnishing. It is a proven fact that the addition of tumbling powder, moistened with burnishing compound, helps to prevent rust on the steel shot. The tempered steel shot will impart a uniform, scratch free, work hardened surface on all metals. After use, carbon steel shot must be rinsed clean and stored in a rust preventive solution.

Stainless Steel Shot (S.S): Unlike carbon steel, this media needs no rust protection. Heavier in weight and corrosion resistant, this shot may be safely used with acid soap solutions. Selection of the shape is determined by the form of the work pieces. Pins are the ideal choice for finishing intricate cavities and filigree. This media must be cleansed in water, then dried and stored.

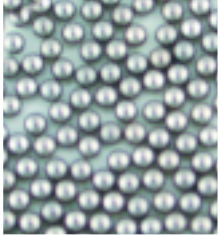

Balls			bx/10 lb
52-1311	Balls - $\frac{1}{16}$ "	C.S	
52-1312	Balls - $\frac{3}{16}$ "	C.S	
52-1351	Balls - $\frac{1}{8}$ "	S.S	
52-1352	Balls - $\frac{3}{16}$ "	S.S	



Pins			bx/10 lb
52-1323	Pins - $\frac{1}{16}$ " X $\frac{9}{32}$ "	C.S	
52-1324	Pins - $\frac{1}{8}$ " X $\frac{3}{8}$ "	C.S	
52-1363	Pins - $\frac{1}{16}$ " X $\frac{9}{32}$ "	S.S	
52-1364	Pins - $\frac{1}{8}$ " X $\frac{3}{8}$ "	S.S	



Ball Cones			bx/10 lb
52-1315	Ball Cones - $\frac{1}{8}$ "	C.S	
52-1316	Ball Cones - $\frac{3}{16}$ "	C.S	
52-1355	Ball Cones - $\frac{1}{8}$ "	S.S	
52-1356	Ball Cones - $\frac{3}{16}$ "	S.S	



Diagonals			bx/10 lb
52-1331	Diagonals - $\frac{1}{8}$ "	C.S	
52-1371	Diagonals - $\frac{1}{8}$ "	S.S	



Eclipse			bx/10 lb
52-1319	Eclipse - $\frac{1}{8}$ "	C.S	
52-1320	Eclipse - $\frac{3}{16}$ "	C.S	
52-1359	Eclipse - $\frac{1}{8}$ "	S.S	
52-1360	Eclipse - $\frac{3}{16}$ "	S.S	



Mixed Shot			bx/10 lb
52-1340	Mixed Shot	C.S	
52-1380	Mixed Shot	S.S	

18. Ceramic Media

Ceramic bonded aluminum oxide is the recommended break-in media for initial rough finishing on raw casting or hard metals. The heavy or medium cut is a reflection of the particle size of the abrasive.

Triangular media eliminates jamming and is designed to reach into grooves, corners or shallow contours.

Cylinder shapes with their gentle rolling motion may be used in a secondary operation to smooth the surface.

Keep the media moist during tumbling by adding a burnishing or a light soapy compound.

Sold bx/50 lb



ITEM #	DESCRIPTION
52-1431	Δ - TRIANGLE - $\frac{3}{16}$ " X $\frac{1}{4}$ " GRAY
52-1433	// - ANGLE CUT CYL - $\frac{3}{16}$ " X $\frac{5}{16}$ " GRAY
52-1435	TRI-STAR- $\frac{5}{16}$ " X $\frac{1}{4}$ "

19. Plastic Media

Plastic bonded abrasive pellets are an excellent choice for providing a uniform finish on medium hard or soft metal. Improve surface finish gradually from coarse to fine.

Blue pyramids (fast cut) are best for the initial stage.

Green pyramids (general purpose) leave a smooth matte finish.

Lt. Green pyramids (smooth finish) will impart a high shine.

Sold bx/50 lb



52-1410 52-1412 52-1414 52-1416 52-1418

ITEM #	DIMENSIONS
52-1410	$\frac{1}{4}$ " - BLUE-PYRAMIDS (XV)
52-1412	$\frac{1}{4}$ " - GREEN-PYRAMIDS (X)
52-1414	$\frac{1}{4}$ " - LT.GREEN-PYRAMIDS (V)
52-1416	$\frac{1}{2}$ " - CYLINDER WEDGE
52-1418	$\frac{9}{16}$ " - CONE- X

Guidelines for Surface Finishing: The acceptable media to part ratio is approximately 70% media to 30% parts. When running conventional media that require a wet process, be sure to have the correct amount of water and compound. Excess water will hamper the vibratory action thus giving less than the desired results. Media and compound should be just wet with no standing water. Use of a compound rinsing system will ensure proper dispensing of water and compound.



20. Porcelain Balls

This micro abrasive media will cut, clean and leave an extremely smooth surface that is bright, but not reflective. Easier to maintain than steel shot, the tumbling action of this media will reach into small cavities without getting entrapped. Use with a soapy liquid detergent to generate improved surfaces.

A mix of ball sizes in a single charge will produce a more refined surface quality.



ITEM #	DESCRIPTION
52-1420	1MM- 5 LBS
52-1422	2MM- 5 LBS
52-1424	3MM- 5 LBS
52-1426	4MM- 5 LBS
52-1428	6MM- 5 LBS

22. Walnut Shell

Granulated walnut shell is a natural carrier for dry tumbling or barrel finishing operations. When charged with polishing oxides, either rouge or chrome, a surface of high luster is achieved.



ITEM #	WEIGHT
52-1471	5 LBS
52-1473	50 LBS

24. Dri- Shine

Dri- Shine I: A ready to use polishing agent made of pulverized walnut shell treated with red rouge.

When run in excess of 5 hours in a vibratory tumbler this media provides excellent coloring characteristics

Dri- Shine III: Formulated from pulverized corn cob and blended with a polishing agent, this media will eliminate rouge stains. Gives a better finish than Dri-shine I.

Dri- Shine VII: A nut based media for final polishing applications. This media will impart a tarnish free, superior bright luster on metals. Normal cycle times will be about 20-45 minutes depending on the application

Note: It is important to alternate the media between cycles. In some cases media can overheat. To prevent condensation, change the media between cycles.

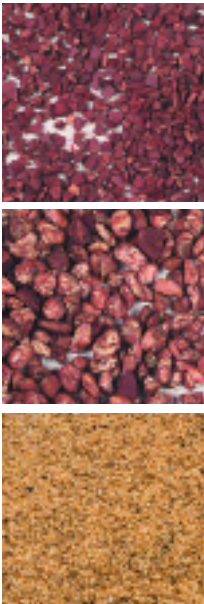

ITEM #	DESCRIPTION	PKG
52-1461	DRI-SHINE I	15 LBS
52-1462	DRI-SHINE I	30 LBS
52-1463	DRI-SHINE III	15 LBS
52-1464	DRI-SHINE III	30 LBS
52-1467	DRI-SHINE VII	5 LBS

21. Steel Shot- Balls

Hardened polished balls may be used for very light deburring. Due to their minute size, a high degree of polish is achieved by a strong peening action. Recommended for use in rotary Tumbler with the addition of burnishing compound. A complement of mixed sizes will generate excellent results on almost all metals.

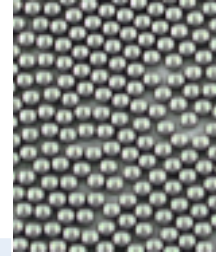

TEM #	DESCRIPTION
52-1451	1.0MM- 200G
52-1452	1.2MM- 200G
52-1453	1.4MM- 200G
52-1454	1.6MM- 200G

23. Corn Cob

Finely ground corn cob is an ideal absorbent for drying articles of jewelry. Additionally, it removes water stains, finger prints, or residue left after tumbling with dry media.



ITEM #	WEIGHT
52-1481	5 LBS
52-1483	50 LBS

25. SS Media Pins & Balls

These quality stainless steel pins and balls are used in magnetic finishers along with a small amount of mild detergent to assist in superior deburring and polishing operations. For delicate jewelry and sharp inside corners, use smaller sized pins. Accelerated finishing can be accomplished by adding up to 10% of balls with the media pins.

ITEM #	DESCRIPTION
52-1490	PIN 0.3 X 5MM 100G
52-1491	PIN 0.3 X 5MM 250G
52-1492	PIN 0.4 X 5MM 250G
52-1493	PIN 0.5 X 5MM 250G
52-1494	PIN 0.6 X 5MM 250G
52-1495	BALL 1.2MM 200G



Note: Do not store pins in the bowl on the machine. Doing so will cause the pins to magnetize, thus lessening their effectiveness. Discoloration of the pins is normal. Pins can be cleaned using tri-phosphate solution. TSP is available at any hardware store.

26. Magnetic Separators

Separate media from parts with this trigger activated accessory. Fast, simple hold and release action, easy to stir in the bowl and discharge the media into the plastic container. Media can then be stored and reused.

ITEM #	DESCRIPTION
52-1501	SMALL
52-1502	LARGE

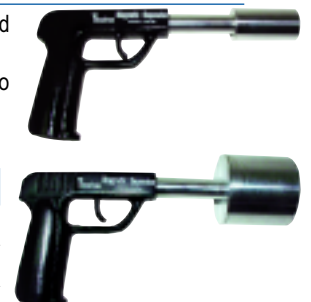



27. Burnishing Compound- Powder

These Burnishing Compounds are non-hazardous and formulated for use with carbon steel shots in Rotary Tumblers. They may also be used with a flow thru system in a vibratory Tumbler.

Mixed 2-4 oz. per gallon of water.

#750: Contains a rust inhibitor to prevent carbon steel shots from oxidation.

#910: May be used during tumbling to enhance the finish of precious metals.

#950: Designed for giving a bright finish to platinum.



ITEM #	DESCRIPTION
52-1511	750 COMPOUND -5 LB
52-1512	750 COMPOUND - 50 LB
52-1515	910 COMPOUND -5 LB
52-1516	910 COMPOUND -50 LB
52-1517	950 COMPOUND -5 LB
52-1518	950 COMPOUND -50 LB

28. Burnishing Additive

Adding just one ounce of this burnishing additive per gallon of cleaning solution in tumbler and finishing machines will result in a substantial improvement in performance. This additive is specifically formulated to advance cleaning and cutting operations. Low Ph makes it ideal for use with steel shot. Safe for usage with all precious metals, brass, and bronze.



ITEM #	DESCRIPTION
52-1535	BURNISHING ADDITIVE 8 OZ

32. Blasting Media

Surface preparation is of vital importance before polishing, burnishing and plating. Surface roughness may be improved by blasting with media, either abrasives or glass beads. Different surface finishes may be generated by varying the parameters of the micron size of abrasives and air pressure.

The degree of matte to satin finish depends on the hardness of the material being finished.

Wt. 5 Lbs



ITEM #	DESCRIPTION	GRADE	MICRON
52-1541	GLASS BEADS	COARSE	240
52-1542	GLASS BEADS	MEDIUM	100
52-1543	GLASS BEADS	FINE	60
52-1544	GLASS BEADS	EX-FINE	20
52-1546	ALUMINUM OXIDE	COARSE	180
52-1547	ALUMINUM OXIDE	MEDIUM	100
52-1548	ALUMINUM OXIDE	FINE	80
52-1553	RUBY	FINE	60

29. Magic® Ultra Liquid Burnishing Compound

- Can be used for Magnetic Tumblers or vibratory finishers
- Excellent results on gold, silver, platinum and other soft metals
- Mix 2-3 ozs. per 1 gallon of water.



ITEM #	CAPACITY
52-1522	1 GAL.

30. Burnishing Compound-D

- Use for vibratory and tumbling operation
- Low level ph, best for use with steel shot
- Cleans all precious metals
- Mix 1 fluid oz. to 1 gallon of water



ITEM #	CAPACITY
52-1524	1 QT.
52-1525	1 GALLON

31. Liquid Compound-B

- For cleaning and fast cutting in tumbling operation
- Use for all metals including white metal
- Works with ceramic, plastic and synthetic media
- Mix 1 fluid oz. to 1 gallon of water



ITEM #	CAPACITY
52-1531	1 QT.
52-1532	1 GALLON

33. Screens

Made of high impact polymer, these screens are approx 14" in diameter, one piece molded and stackable for storage. Various screen sizes are available for manual separation of parts from media.

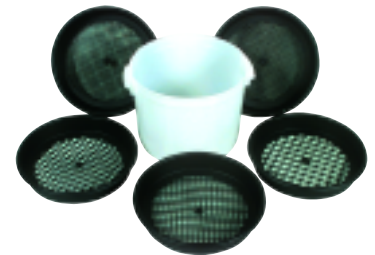

ITEM #	DESCRIPTION
52-1561	SCREEN 1"
52-1562	SCREEN 3/4"
52-1563	SCREEN 1/2"
52-1564	SCREEN 3/8"
52-1565	SCREEN 1/4"
52-1567	BUCKET WITH 5 SCREENS



34. Sand Blaster

A sturdy stainless steel sand blaster with a sealed enclosure to eliminate leakage. Illuminated viewing area with mylar (peelable) protected viewing glass. Pencil style steel nozzle operates at 40-90 PSI. air pressure. Nozzle may be used in a fixed mount or free hand. Media is recyclable. **Compressor not included.**

Unit includes: Regulator, Pressure Gauge, Dust Filter, Blasting Nozzle, Latex Gloves and PL light. A front loading and discharge port for media. Control panel with fuse 3A power switch and pilot lamp.

Dual voltage 110/220V. Dimensions: 20" L X 14" W X 17" Ht. Wt.: 27 lbs

ITEM #	DESCRIPTION
--------	-------------

52-1711	SAND BLASTER
---------	--------------

35. Pen Style Sand Blaster

Features one piece molded construction for a clear work area view. Light weight and portable, this unit is designed for etching and texturing applications. Side openings with heavy duty latex gloves. Fixed or free hand pencil style nozzle. Operates at 42-70 PSI. Media is recyclable.

Unit includes: Regulator, Pressure Gauge, Dust Filter, Blasting Nozzle and Latex Gloves. front loading and discharge port for media.

Dimensions: 20" L X 17" W X 17" Ht. Wt.: 12 lbs

ITEM #	DESCRIPTION
--------	-------------

52-1721	PEN STYLE SAND BLASTER
---------	------------------------

52-1722	PEN STYLE SAND BLASTER WITH COMPRESSOR
---------	--

36. EZ Sandblaster

The sand blaster uses an air jet that forces blasting media, either glass beads or aluminum oxide, onto the article to remove hardened investment or to generate a smooth surface. The cabinet is a molded one-piece polymer body, resistant to rust or leakage. Blasting media is automatically recirculated. Wt. 18 Lbs. **Compressor not included.**

Unit includes: a convenient easy viewing glass with an internal light. A double filter system, an adjustable air pressure regulator and a self cleaning ceramic nozzle. Media quartz abrasive (5 lbs)

ITEM #	DESCRIPTION
--------	-------------

52-1731	EZ VIEWER 110V / 60 HZ ONE HANDED
---------	-----------------------------------

52-1732	EZ VIEWER 220V / 50 HZ ONE HANDED
---------	-----------------------------------

52-1735	EZ VIEWER 110V / 60 HZ TWO HANDED
---------	-----------------------------------

52-1736	EZ VIEWER 220V / 50 HZ TWO HANDED
---------	-----------------------------------

37. Mini Sand Blaster

A handy light weight unit that is ideal for preparing work for final polishing. Use it for removing oxide heat marks and smoothing surfaces of casting. A lighted interior and a clear viewing window help visibility. Lever control air gun provides a pin point jet. **Compressor not included.**

Unit Includes: Air gun, Neoprene Glove, Light bulb, and 5 lb. blasting media.

ITEM #	DESCRIPTION	DIMENSIONS
--------	-------------	------------

52-1741	110V / 60 HZ ONE HAND	11" X 11" X 11"
---------	-----------------------	-----------------

52-1742	220 V / 50 HZ ONE HAND	11" X 11" X 11"
---------	------------------------	-----------------

Sand blasters operate on 40-90 PSI.
For Air Compressor See page # 146.



TAGS

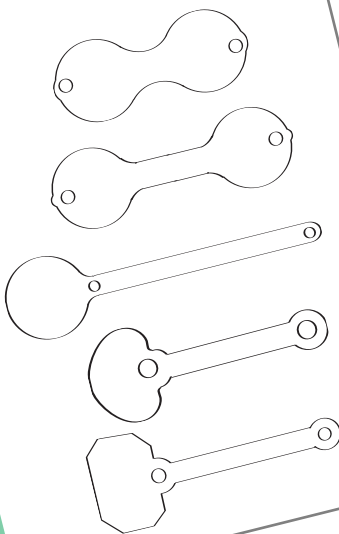

■ Anti-Tarnish Tissue	292
■ Button Jewelry Tags	292
■ Gift Bags	292
■ Jewelry Pins	292
■ Paper Cutter	292
■ PVC Reclosable Bags	292
■ Repair Envelopes with Lay Away	290
■ Ring Tags	291
■ Ring Tags for Dot Matrix Printer	290
■ String Tags	291
■ String Tags for Dot Matrix Printer	292
■ Turn Table	292
■ Zip Lock Bags	291



 **Ikohe**



The Design and Creation of Jewelry by Robert Von Neumann

A complete reference guide showing traditional and contemporary methods and materials of jewelry making. Learn basic and specialized metalworking, shaping and decorative techniques. Covers cutting, stamping, pickling, coloring, polishing and design transfer methods.

61-1011 (Softcover – 321 pages)



1. String Tags- Paper

- Use for organizing, labeling or pricing
- Made of heavyweight white quality paper
- Box of 1000 approx.

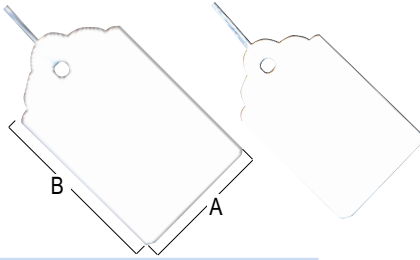

SIZE (AXB)	ITEM #
8 X 16 MM	53-1011
8 X 20 MM	53-1012
10 X 22 MM	53-1013
13 X 25 MM	53-1014
16 X 25 MM	53-1015
19 X 28 MM	53-1016

2. String Tags- PVC

- Ideal for use in organizing, labeling or pricing
- Made of tear resistant PVC with rounded edges and strung with attractive gold string
- Tags will accept marking with indelible pen
- Box of 1000 approx.

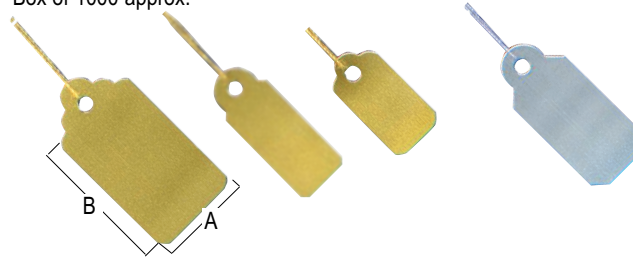

SIZE (AXB)	WHITE	GOLD	SILVER
8 X 16 MM	53-1021	53-1031	53-1041
8 X 20 MM	53-1022	53-1032	53-1042
10 X 22 MM	53-1023	53-1033	53-1043
13 X 25 MM	53-1024	53-1034	53-1044
16 X 25 MM	53-1025	53-1035	53-1045
19 X 28 MM	53-1026	53-1036	53-1046

3. Ring Tags

Attractive and functional, these ring tags are made in super strong Tyvek material. Solution resistant to withstand repeated ultrasonic or steam cleaning. Tags have pressure sensitive backing with an adhesive free center for easy application. Choose from a wide selection of five colors and shapes. Comes in packs with an indelible ink marker.

<p>PK/1000</p> <table border="1"> <thead> <tr> <th>COLOR</th> <th>ITEM #</th> </tr> </thead> <tbody> <tr> <td>WHITE</td> <td>53-1051</td> </tr> <tr> <td>GOLD</td> <td>53-1052</td> </tr> <tr> <td>SILVER</td> <td>53-1053</td> </tr> <tr> <td>BLUE</td> <td>53-1054</td> </tr> <tr> <td>YELLOW</td> <td>53-1055</td> </tr> </tbody> </table>	COLOR	ITEM #	WHITE	53-1051	GOLD	53-1052	SILVER	53-1053	BLUE	53-1054	YELLOW	53-1055	<p>PK/500</p> <table border="1"> <thead> <tr> <th>COLOR</th> <th>ITEM #</th> </tr> </thead> <tbody> <tr> <td>WHITE</td> <td>53-1061</td> </tr> <tr> <td>BLUE</td> <td>53-1064</td> </tr> <tr> <td>YELLOW</td> <td>53-1065</td> </tr> </tbody> </table>	COLOR	ITEM #	WHITE	53-1061	BLUE	53-1064	YELLOW	53-1065	<p>PK/1000</p> <table border="1"> <thead> <tr> <th>COLOR</th> <th>ITEM #</th> </tr> </thead> <tbody> <tr> <td>WHITE</td> <td>53-1071</td> </tr> <tr> <td>BLUE</td> <td>53-1074</td> </tr> <tr> <td>YELLOW</td> <td>53-1075</td> </tr> </tbody> </table>	COLOR	ITEM #	WHITE	53-1071	BLUE	53-1074	YELLOW	53-1075	<p>PK/500</p> <table border="1"> <thead> <tr> <th>COLOR</th> <th>ITEM #</th> </tr> </thead> <tbody> <tr> <td>WHITE</td> <td>53-1081</td> </tr> <tr> <td>BLUE</td> <td>53-1084</td> </tr> <tr> <td>YELLOW</td> <td>53-1085</td> </tr> </tbody> </table>	COLOR	ITEM #	WHITE	53-1081	BLUE	53-1084	YELLOW	53-1085	<p>PK/500</p> <table border="1"> <thead> <tr> <th>COLOR</th> <th>ITEM #</th> </tr> </thead> <tbody> <tr> <td>WHITE</td> <td>53-1091</td> </tr> <tr> <td>YELLOW</td> <td>53-1095</td> </tr> </tbody> </table>	COLOR	ITEM #	WHITE	53-1091	YELLOW	53-1095
COLOR	ITEM #																																													
WHITE	53-1051																																													
GOLD	53-1052																																													
SILVER	53-1053																																													
BLUE	53-1054																																													
YELLOW	53-1055																																													
COLOR	ITEM #																																													
WHITE	53-1061																																													
BLUE	53-1064																																													
YELLOW	53-1065																																													
COLOR	ITEM #																																													
WHITE	53-1071																																													
BLUE	53-1074																																													
YELLOW	53-1075																																													
COLOR	ITEM #																																													
WHITE	53-1081																																													
BLUE	53-1084																																													
YELLOW	53-1085																																													
COLOR	ITEM #																																													
WHITE	53-1091																																													
YELLOW	53-1095																																													

4. Button Jewelry Tags

A complete range of elegant jewelry tags in different shapes to suit all applications. Made in ultrasonic compatible PVC, tags are available in frosted white, gold and silver, with transparent press on buttons. Write or mark with an indelible pen. Box of 1000 approx.

<p>SMALL ROUND PK/1000</p> <table border="1"> <thead> <tr> <th>COLOR</th> <th>ITEM #</th> </tr> </thead> <tbody> <tr> <td>WHITE</td> <td>53-1111</td> </tr> <tr> <td>GOLD</td> <td>53-1112</td> </tr> <tr> <td>SILVER</td> <td>53-1113</td> </tr> </tbody> </table>	COLOR	ITEM #	WHITE	53-1111	GOLD	53-1112	SILVER	53-1113	<p>LARGE ROUND PK/1000</p> <table border="1"> <thead> <tr> <th>COLOR</th> <th>ITEM #</th> </tr> </thead> <tbody> <tr> <td>WHITE</td> <td>53-1121</td> </tr> <tr> <td>GOLD</td> <td>53-1122</td> </tr> <tr> <td>SILVER</td> <td>53-1123</td> </tr> </tbody> </table>	COLOR	ITEM #	WHITE	53-1121	GOLD	53-1122	SILVER	53-1123	<p>SINGLE END ROUND PK/1000</p> <table border="1"> <thead> <tr> <th>COLOR</th> <th>ITEM #</th> </tr> </thead> <tbody> <tr> <td>WHITE</td> <td>53-1131</td> </tr> <tr> <td>GOLD</td> <td>53-1132</td> </tr> <tr> <td>SILVER</td> <td>53-1133</td> </tr> </tbody> </table>	COLOR	ITEM #	WHITE	53-1131	GOLD	53-1132	SILVER	53-1133	<p>SINGLE END OVAL PK/1000</p> <table border="1"> <thead> <tr> <th>COLOR</th> <th>ITEM #</th> </tr> </thead> <tbody> <tr> <td>WHITE</td> <td>53-1141</td> </tr> <tr> <td>GOLD</td> <td>53-1142</td> </tr> <tr> <td>SILVER</td> <td>53-1143</td> </tr> </tbody> </table>	COLOR	ITEM #	WHITE	53-1141	GOLD	53-1142	SILVER	53-1143	<p>SINGLE END RECT. PK/1000</p> <table border="1"> <thead> <tr> <th>COLOR</th> <th>ITEM #</th> </tr> </thead> <tbody> <tr> <td>WHITE</td> <td>53-1151</td> </tr> <tr> <td>GOLD</td> <td>53-1152</td> </tr> <tr> <td>SILVER</td> <td>53-1153</td> </tr> </tbody> </table>	COLOR	ITEM #	WHITE	53-1151	GOLD	53-1152	SILVER	53-1153
COLOR	ITEM #																																											
WHITE	53-1111																																											
GOLD	53-1112																																											
SILVER	53-1113																																											
COLOR	ITEM #																																											
WHITE	53-1121																																											
GOLD	53-1122																																											
SILVER	53-1123																																											
COLOR	ITEM #																																											
WHITE	53-1131																																											
GOLD	53-1132																																											
SILVER	53-1133																																											
COLOR	ITEM #																																											
WHITE	53-1141																																											
GOLD	53-1142																																											
SILVER	53-1143																																											
COLOR	ITEM #																																											
WHITE	53-1151																																											
GOLD	53-1152																																											
SILVER	53-1153																																											



5. Ring Tags for Dot Matrix Printer

Durable, rip proof tags in five colors that will withstand ultrasonic or steam cleaning. Print professional quality details using indelible ink ribbon on your dot matrix printer or typewriter.

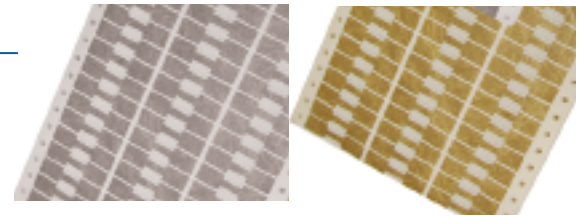
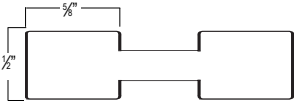
REGULAR BX/1000	
COLOR	ITEM #
WHITE	53-1211
GOLD	53-1212
SILVER	53-1213
BLUE	53-1214
YELLOW	53-1215



REGULAR BX/10000	
COLOR	ITEM #
WHITE	53-1221
GOLD	53-1222
SILVER	53-1223
BLUE	53-1224
YELLOW	53-1225



MYLAR® BX/1000	
COLOR	ITEM #
WHITE	53-1231
GOLD	53-1232
SILVER	53-1233
BLUE	53-1234
YELLOW	53-1235

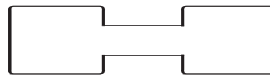

MYLAR® BX/10000	
COLOR	ITEM #
WHITE	53-1241
GOLD	53-1242
SILVER	53-1243
BLUE	53-1244
YELLOW	53-1245

6. String Tags for Dot Matrix Printer

Ready to use tear resistant tags, for instant identification. Ultrasonic and steam cleaner safe. Available in white, gold or silver.

PACKAGE	WHITE	GOLD	SILVER
BX / 500	53-1251	53-1253	53-1255
BX / 5000	53-1252	53-1254	53-1256

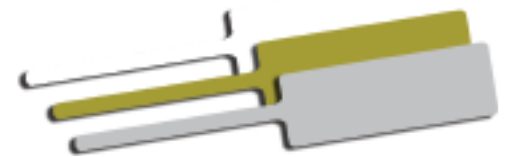
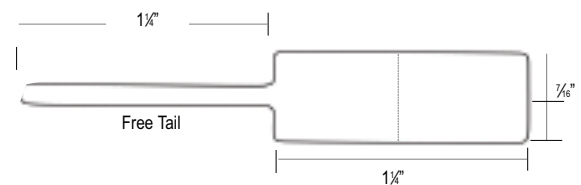

7. Zip Lock Bags

Clear, transparent, tough poly bags for instant identification of items in every shop or store. Long lasting reinforced zip for added security and strength for use and reuse. In addition, the interlock seal protects the contents from moisture and grime. **Bx/1000**

SIZE	QTY		
	CASE	BLOCK	PLAIN
1 1/2" X 2"	20K	53-1261	53-1281
1 1/2" X 1 1/2"	20K	53-1262	53-1282
2" X 2"	20K	53-1266	53-1286
2" X 3"	20K	53-1267	53-1287
2" X 8"	4K	—	53-1288
3" X 3"	12K	53-1269	53-1289
3" X 4"	10K	53-1270	53-1290
3" X 5"	10K	53-1271	53-1291
4" X 6"	4K	53-1273	53-1293
5" X 6"	4K	53-1275	53-1295
6" X 9"	2K	53-1277	53-1297
8" X 10"	2K	53-1279	53-1299
9" X 12"	2K	53-1280	53-1300

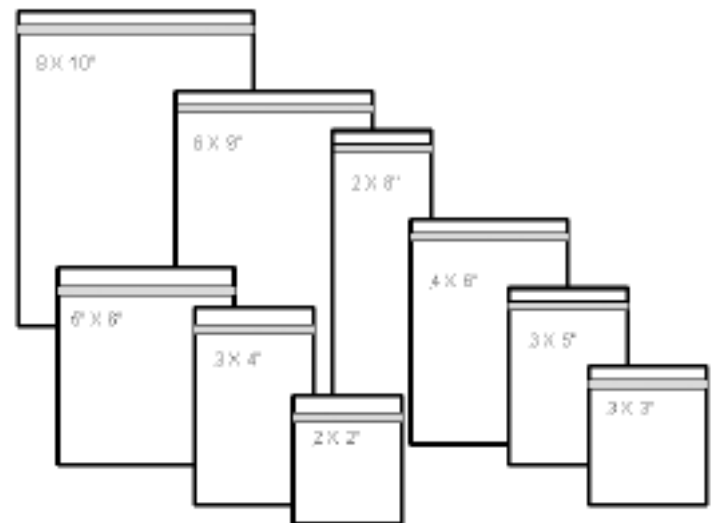



8. PVC Reclosable Bags

Completely clear, thick poly bags in popular sizes, for multiple uses around the store or shop.

Simply press to seal. Very useful for storing customer parts, samples, findings, and other items.

Bx/100.

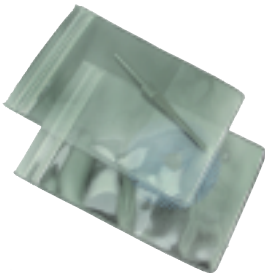

ITEM #	SIZE
53-1311	3" X 2"
53-1312	4" X 3"
53-1313	5" X 3"
53-1314	6" X 4"

9. Jewelry Pins

Silver or Gold jewelry pins with sharp points for pinning all types of jewelry to pads, trays, and easels.

Bx/1000



ITEM #	DESCRIPTION
53-1361	SILVER
53-1362	GOLD

10. Coin Envelope- Brown Kraft

Small open end envelopes made to the quality standards of dependability and durability. Economical for storing small parts, coins or jewelry. Easy to write on or affix labels.

Bx/500



ITEM #	STYLE
53-1333	#3- 3/4" X 2 1/2"
53-1334	#4- 4 1/2" X 3"
53-1335	#5 1/2- 5 1/4" X 7 1/8"
53-1336	#6- 6" X 3 3/8"

11. Repair Envelopes with Lay Away

Triple duty printed envelopes let you organize repair jobs efficiently. Three detachable parts preprinted and progressively numbered.

Printed with Lay Away for easy processing. Holder to be ordered separately.

Bx/1000.



ITEM #	DESCRIPTION
53-1321	1-1000
53-1322	1001-2000
53-1323	2001-3000
53-1324	3001-4000
53-1325	4001-5000
53-1330	HOLDER

12. Anti-Tarnish Roll & Paper Cutter

Anti-Tarnish Tissue

Made of the finest quality white bleached tissue. Ideal for wrapping silverware, jewelry and other gift articles. Provides excellent protection from tarnish. Available in rolls of 7 1/8" width X 1000'. **Bx/16.**

Paper Cutter

A stand for dispensing tissue paper rolls. Comes with a drop leaf steel blade that allows clean tear away of any required length.



ITEM #	DESCRIPTION
53-1365	ANTI-TARNISH ROLL
53-1366	PAPER CUTTER

13. Gift Bags

Gift bag in an exquisite rose design. Available in two background colors: silver and gold. Four different sizes in case lots. **Bx/1000**



SIZE	QTY CASE	SILVER	GOLD
		53-1341	53-1351
4" X 6"	5K	53-1342	53-1352
5" X 7"	5K	53-1343	53-1353
6" X 9"	6K	53-1344	53-1354
8 1/2" X 11"	2K		

14. Turn Table

An attractive, low level, platform top display table that adds splendor to jewelry creations. Quiet smooth movement provides all around viewing. Comes in two colors, silver and gold.



SIZE	SILVER	GOLD
5" X 2 1/2"	53-1371	53-1381
7" X 2 1/2"	53-1372	53-1382
12" X 2 1/2"	53-1374	53-1384

15. Counter top Mirror

An elegant oval counter top frameless mirror on a polished chrome stand. Rotates and adjusts to any angle. Size : 15" X 10 1/2".



ITEM #	DESCRIPTION
53-1391	MIRROR - 15" X 10 1/2"



TESTING



■ Diamond Pencil	296
■ Diamond Testers	296
■ Garrett® Metal Detectors	295
■ Gem Testers Presidium®	296
■ Gold Testing Kits & Needle	294
■ Precious Metal Tester	295
■ Test Acids	294
■ Test Stones	294





PRESIDIUM

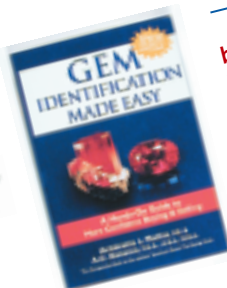

Gem Identification Made Easy

by **Antoinette L. Matlins & A. C. Bonanno**
 Easy-to-read book that explains how to use pocket, portable and laboratory instruments to identify diamonds and colored gems. Learn how to recognize real gems from imitations. Provides the latest information on treatments to improve a gem's appearance.

61-1237 (Hardcover – 270 pages)



1. Test Stones- Jet Black

Best quality natural jet black hard Arkansas gold testing stone. Use for determining the carat content of jewelry. Available with or without durable wood box.

Boxed

ITEM #	DIMENSION
54-1012	3" X 1½" X ½"
54-1015	6" X 2" X ½"
54-1017	8" X 2" X ½"

Natural

54-1011	2" X 1½" X ½"
---------	---------------

Natural

ITEM #	DIMENSION
54-1021	40 X 35 X 6MM
54-1025	3" X 1½" X ½"
54-1029	6" X 2" X ½"
54-1030	6" X 2½" X ½"
54-1031	6" X 3" X ½"
54-1035	8" X 3" X ½"



2. Gold Testing Kits

Traditional kits used worldwide for testing gold, silver and platinum.

ITEM #	DESCRIPTION
54-1042	KIT (BOX WITH ACID AND STONE)
54-1043	KIT WITH 5 NEEDLE POINTS
54-1046	5 COMPARTMENT BOX
54-1047	8 COMPARTMENT BOX
54-1049	GOLD TEST GLASS STONE 2" X 2"

Needle Points

3 points (10, 14, 18) Karat; **4 points** (10, 14, 18, 0.999 & silver; **5 points** (8, 10, 12, 14,18) Karat; **9 points** (4, 6, 8, 10, 12, 14,18, 20k) Karat; **H.K** (14, 18, 21, 22k) Karat

ITEM #	DESCRIPTION	ITEM #	DESCRIPTION
54-1051	3 POINTS	54-1057	9 POINTS
54-1052	4 POINTS	54-1058	HK
54-1053	5 POINTS		

3. Test Acids

This solution helps test silver and the carat value of gold. Comes in plastic bottles with secure color coded caps. Contents ½ oz. **Bx/12**



ITEM #	DESCRIPTION
54-1061	TEST ACID -10K GOLD
54-1062	TEST ACID -14K GOLD
54-1063	TEST ACID -18K GOLD
54-1064	TEST ACID -22K GOLD
54-1068	TEST ACID -PLATINUM
54-1071	TEST ACID -SILVER

4. Culti Diamond Testers - Japan

Improved positive sensing distinguishes the look alike from the genuine. A very reliable tester that identifies natural diamond from white corundum, Y.A.G. and other simulant. Advanced electronic display. Supported by manufacturer's warranty.



54-1121

*IC chip built-in for pin point accuracy
Genuine diamond indicated by a red light and beep.
Moissanite cannot be distinguished by these testers.
Two AAA alkaline batteries(included), loose stone
holder and case.*

ITEM #	DESCRIPTION
54-1121	DIAMOND TESTER CULTI 111



5. Garrett® Hand Held Metal Detector

A world renowned hand held metal detector to identify even the smallest metal object. Operates on a low frequency range. Completely safe and reliable.

Features:

- Ultimate sensitivity, one switch operation
- Rugged, high impact ABS case with coil compartment
- Detects medium to very tiny foil wrapped articles
- Large 10" scan surface for thorough scanning
- Sharp audible alarm and bright red LED light indicator
- Operates on 9V battery or rechargeable 7.2V (Ni-Mh)



ITEM #	DESCRIPTION
54-1092	HAND-HELD METAL DETECTOR

6. Garrett® GTP 1350 Metal Detector

An affordable high performance mid range detector with microprocessor graphics target analyzer. Easy to operate by beginners and professionals. Includes continuous instant display system with (DSP) Digital Signal Processor. Target with pin point accuracy to a 20% greater depth than most other detectors. Features different modes, search aids, and settings.

Features:

- Touchpad controls
- Sensitivity/ Depth adjustment
- Scantrack
- Adjustable frequency and volume
- Graphic Target Analyzer
- Graphic Target Profiling
- Supported by manufacturer's warranty
- Detection Frequency: 7.2 kHz
- The GTP 1350 comes with the 7" X10" PROformance searchcoil and video
- Length 40-51" Wt. 4.0 lbs



Optional Searchcoils available

ITEM #	DESCRIPTION
54-1091	GTP 1350 METAL DETECTOR

7. Precious Metal Tester

GK-300 is a high precision tester that easily determines the purity of all precious metals: gold, silver and platinum. A computer with installed software calculates the caratage and percentage based on the specific gravity of the sample.

GK-2000 is an advanced version of the GK300 with a capacity up to 2,100g. This is useful for measuring larger objects like ingots, etc. The GK -2000 calculates the purity of both gold, silver and platinum.

Unit Includes:

- Senser • Water Tank • Holder • Support
- Machine Body • AC Adapter • Tweezers
- Thermometer • Calibration weight

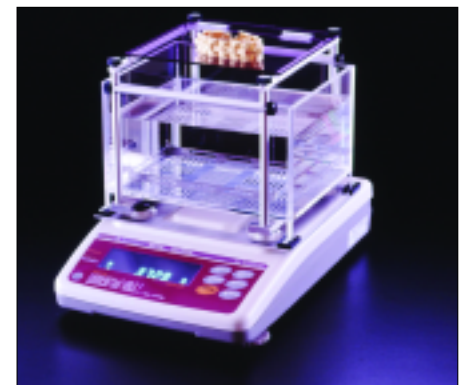

Model	GK-300	54-1111	GK-2000	54-1114
Measuring Range	0.01-300g		0.01-2,100g	
Measurable Range	5-300g		10- 2,100g (Gold and Platinum)	
Display	Gold (lo, k9, 10, 12, 14, 16, 18, 20, 21, 23, 24) Purity (%), density		Gold (lo, k9, 10, 11, 12, 13, 14, 15, 16, 17, 18, 19, 20, 21, 22, 23, 24) Platinum (lo, Pt600, 650, 700, 750, 800, 850, 900, 950, 1000) Purity (%), density	
Dimensions / Weight	218 x 190 x 170 MM / 1.54 kg		317 x 210 x 235 MM / 5.50 kg	
Option	Printer AD-8121B, Airtight Windshield, AC adapter (110-240V)		Printer AD-8121B, 2 kg calibration weight	
Measuring Mode	Gold, alloyed metals, % & density, calibration		Gold, Pt, alloyed metals, calibration	



8. PRESIDIUM Diamond Testers

Professional, compact, sleek penlike instrument. Digital electronic circuitry consistently and reliably distinguishes between diamonds and simulant. Gives an audible continuous beep when diamond is tested. Comes in a vinyl pouch.



Diamond Mate-A: Operates on alkaline AAA batteries (not included). May be used with AC adapter.



Diamond Mate-C: Operates on rechargeable NICAD batteries (not included). May be used with AC adapter.



Moissanite Tester: *Distinguishes diamond from moissanite.* This tester is recommended for use after a positive testing result for diamond with a conductivity tester. Operates on 3 (AAA) alkaline batteries (not included).

ITEM #	DIMENSIONS
54-1131	160 X 30 X 20.5MM

ITEM #	DIMENSIONS
54-1132	160 X 30 X 20.5MM

ITEM #	DIMENSIONS
54-1133	160 X 21 X 30MM

for more diamond testers see page #124

Multi Tester: *The multi-tester distinguishes diamond from CZ and moissanite* by the combined principle of thermal and electrical conductivity from patented technology. Features include a retractable probe that ensures accurate and consistent pressure, LED display and low battery indicator. Operates on 3 (AAA) alkaline batteries (not included).

Diamond Fact: A professional top of the line tester. Instantly separates simulant from the genuine. Small compact pocket model has needle tip testing point for stones as small as 0.02 carat. Operates on two AA batteries (not included).

Gem Tester: The gem tester instantly separates diamond from all known simulants. A probe measures the rate of heat being conducted away from the stone. The gem tester can be used on mounted and unmounted stones as small as 0.02 carat. Comes complete with an AC adapter in a velvet lined box. Also operates on two AA batteries (not included).



Distinguishes Diamond from simulated stones.



ITEM #	DIMENSIONS
54-1134	160 X 30 X 20.5MM

ITEM #	DIMENSIONS
54-1135	92 X 22 X 68MM

ITEM #	DIMENSIONS
54-1136	180 X 96 X 72MM

9. IKOHE Moissanite Tester

The revolutionary new tester that outsmarts and even detects moissanite, which is a simulant for diamond. Ultra sensitive, can check stones of 0.01 carat or less. Readings displayed on both sides allowing use in either hand. Backed by manufacturer's warranty.



Separates synthetic moissanite from diamonds after testing with a conventional diamond tester. Flashing green light indicates that stone is moissanite or synthetic. Operates on one 9V alkaline battery (included)

ITEM #	DESCRIPTION
54-1137	MOISSANITE TESTER - (Battery included)

10. Diamond Scribe

An easy to use tool to determine if a stone is a diamond. Use the fine point to make a scratch across the stone. If a streak appears it is not a diamond. Retractable point for protection. Clips on to your pocket.



Retractable point

ITEM #	DESCRIPTION
54-1141	DIAMOND SCRIBE



TORCHES

■ Acetylene Air Kit	302
■ Air Acetylene Tips	302
■ Bench Torch Holders	305
■ Butane Torches	305
■ Caddy Kits	299
■ Combustible Gas Alarm	303
■ Dual Hose	303
■ Empty Cylinders and Tanks	301
■ Flashback Arrestors	301
■ Gasaver	303
■ Harris Melting Kits	304
■ Heating Tips	300
■ HOKE Type-Jewel Torch & Adapter Kits	304
■ Hose Connector	301
■ Hose & Connection	300
■ HydroGem	304
■ Kits with Regulator - Disposable Tanks	298
■ Little Torch Kits	298
■ Magnetic Torch Stand	305
■ Preset Regulators for Disposable Tank	300
■ Regulator Check Valves	301
■ Safety Goggles for Platinum	305
■ Single Stage Regulators	300
■ Smith Casting Melting Torch	303



■ Smoothy Flamless Finisher	305
■ The EZ Torch	306
■ The Swiss Torch	306
■ Tips	299
■ Torch Holder-Deluxe	305
■ Torch Lighter & Flint	305
■ Torch Mate Lighter	304
■ Two Hose Manifolds	301
■ Two Stage Regulators	300
■ Valve Assemblies	305

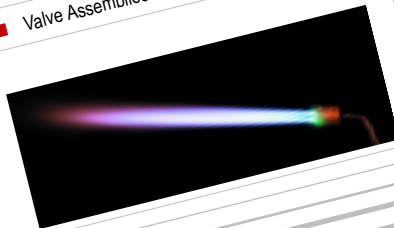
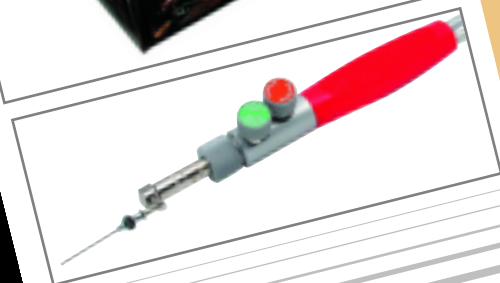

ikohe

SMITH

The Little Torch™



Ring Repair

by Alan Revere

Documents the repair, alteration and restoration of rings in gold, silver and platinum. This book is full of trade secrets and tips and is indispensable to anyone who works with rings. A combination of text and photography presents every step of each project in a clear, concise manner. Includes 140 color photos and 90 sketches.

61-1222 (Softcover - 128 pages)



The Little Torch™ 1. Kits

Designed for jewelry repair and manufacture, hobby, crafts and metal sculpture. Supplied in a display box, the Little Torch is engineered for light brazing and soldering.



SMITH

ITEM #	DESCRIPTION
ACETYLENE KIT:	
55-1011	23-1001D Includes torch, size #3-7 curved tips, 8' hoses and complete instruction manual. Encased in display box as shown ("B" hose connections fuel 3/8"-18-LH, Oxygen 1/2"-18-RH)
55-1013	239-047B Includes torch, size #2-6 curved tips, 8' hoses and complete instruction manual with BRITISH hose connections (Fuel 1/4"-19 BSPF-LH, Oxygen 1/4"-19 BSPF-RH)
55-1015	249-048A Includes torch, size #2-6 curved tips, 8' hoses and complete instruction manual with EUROPEAN hose connections (Fuel 1/4"-19 BSPF-RH, Oxygen 1/4"-19 BSPF-RH)
55-1017	23-1013A Includes torch, size #2-6 curved tips, 8' hoses and complete instruction manual with AUSTRALIAN hose connections (Oxygen 1/2"-18-RH, Fuel 3/8"-18-LH)



55-1021



The Little Torch™

2. Kits with Regulator - For Disposable Tanks

Unmatched flexibility - these kits can be used with several fuels including acetylene, propane, MAPP®, or natural gas. It produces a perfectly controlled stable hot flame to melt weldable metals, glass and even ceramics.

* Kit shown may be used with disposable MAPP® or propane and oxygen cylinders (Cylinders not included).
Note: Disposable oxygen and fuel tanks may be purchased at hardware stores. Not to be used with LP multiflame (rosebud tip)

ITEM #	DESCRIPTION
55-1021	23-1014 Includes pre-set oxygen regulator, preset propane regulator, cylinder holder, torch, size 5 tip, 8 ft. hoses and complete instruction manual. Allows maximum portability. (Tanks not included)
55-1022	23-1003B Includes torch, #2-6 tips, acetylene regulator (for "B" tank), oxygen regulator, reverse flow check valves, 8' covered hoses and instruction manual.
55-1023	23-1003P Kit with regulator for propane or industrial acetylene cylinders Includes torch, tips #3-7, fuel regulator, oxygen regulator, reverse flow check valve, 8' covered hoses and instruction manual.
55-1024	23-1003 Kit with regulator for "MC" tank small acetylene (10 Cu. Ft. cylinder). Includes torch, tips #2-6, fuel regulator, oxygen regulator, check valves, 8' covered hoses and instruction manual.

Disposable LP tanks are not included





3. Caddy Kits

Acetylene Caddy

Includes torch, #2-6 tips, acetylene regulator, oxygen regulator, and reverse flow check valves, 8' covered hoses, (20 cu. ft.) oxygen cylinder (empty), (10 cu. ft.) acetylene cylinder (empty), caddy carrier, tank wrench and instruction manual.

Oxygen and Acetylene cylinders can be filled at most welding supply stores.

Propane Caddy

Includes refillable propane tank (empty), (20 cu. ft.) oxygen tank (empty), torch with 8' (2.4m) covered hoses, #3-7 tips, oxygen regulator, propane regulator, reverse flow check valves, plated metal carrier and instruction manual.

ITEM #	DESCRIPTION
55-1031	23-1004A ACET. / OXYGEN CADDY KIT COMPLETE
55-1032	23-1015P PROPANE CADDY KIT COMPLETE
55-1033	13493 PLASTIC CADDY ONLY
55-1034	13787A METAL CADDY ONLY (NOT SHOWN)



The Little Torch™

4. Tips

Tips #2-3 sizes, have orifices in synthetic sapphire. Guaranteed needle point flame to do intricate work.

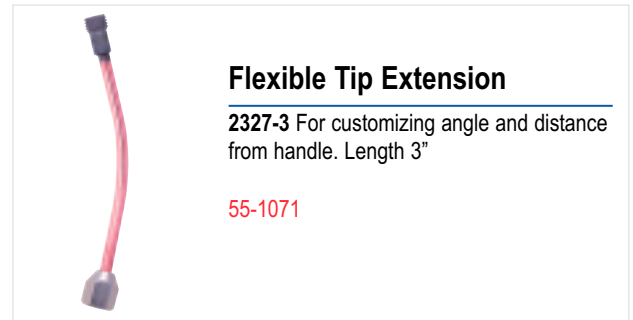

Flexible Tip Extension

2327-3 For customizing angle and distance from handle. Length 3"

55-1071

TIP SIZE	CURVED	STRAIGHT	TWIN FLAME	Use with Oxygen and	Gas Pressures (PSI)	
					oxy	fuel
#2	12-1401-02 55-1042	—	—	Acetylene / Hydrogen	2	2
#3	12-1401-03 55-1043	—	12-1402-03 55-1063	Any Fuel Gas	4	4
#4	12-1401-04 55-1044	129-124-04 55-1054	12-1402-04 55-1064		5	5
#5	12-1401-05 55-1045	—	12-1402-05 55-1065		6	6
#6	12-1401-06 55-1046	—	12-1402-06 55-1066		6	6
#7	12-1401-07 55-1047	—	—		8	8



Tip size #2 is for use with oxygen/acetylene or oxygen/hydrogen only

Approx. Flame size at neutral mixture (Oxy/Acet)

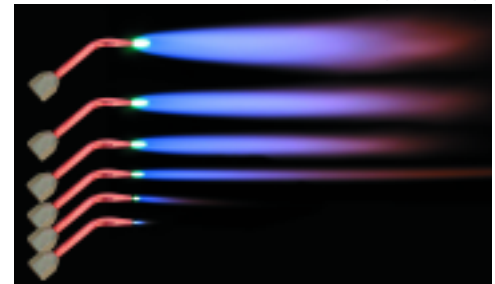

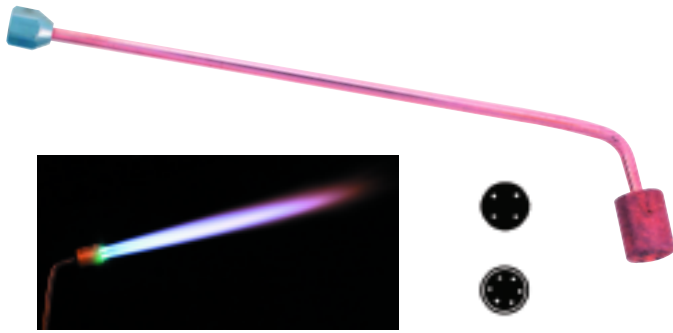

Must Use Accessories



High flow capacity flashback arrestors must be attached to the torch before operating

9. The Little Torch™ Hoses & Connection

Replacement hoses with B (1/16) fittings.
Color coded for easy identification.
Complete with instructions.



ITEM #	DESCRIPTION
55-1135	NUT LH 1/8" HOSE CONNECTION OXY 1/16" 18THD
55-1136	NUT RH 1/8" HOSE CONNECTION FUEL 1/16" 18THD
55-1137	HOSE TAILPIECE FOR OXY/FUEL
55-1138	FERRULE 3/16" - OXY/FUEL
55-1139	CRIMP TOOL FOR FERRULE ASSLY.
55-1141	13254-3-8 8' FUEL GAS HOSE - RED
55-1142	13254-1-8 8' OXY HOSE - GREEN

5. The Little Torch™ Heating Tips

Special purpose multiple orifice 6" in length designed to form a larger heating zone. May be used for melting up to 3 oz. of gold or silver.
Maximum temperature 5400°F for propane and 6000°F for acetylene.

ITEM #	DESCRIPTION
55-1081	13-662 ACETYLENE / HYDROGEN /MAPP®
55-1082	13-717 PROPANE / NATURAL GAS

6. Single Stage Regulators

Economical compact single stage design for dependable control of gas for torches requiring low gas flow and outlet pressure.
Gas connection designation:

- 520- "B" tank 40 cu. ft.
- 200- "MC" tank 10 cu. ft.
- 540- "Oxygen" all tank sizes
- 510- "Large" 60-400 cu. ft. internal threads

ITEM #	DESCRIPTION	CYL. TYPE
55-1111	30-20-540 OXYGEN	CGA540 (B) RH
55-1112	30-15-520 ACETYLENE	CGA520 (B) LH
55-1113	30-15-200 ACETYLENE	CGA200 (B) LH
55-1114	30-15-510 LP & ACETYLENE	CGA510 (B) LH

"B"- 1/16" - 18 THREADS

7. Two Stage Regulators

Control cylinder pressure in two stages for a more accurate pressure and flow regardless of inlet pressure. Recommended when flow must be maintained without variation.

- Gas connection designation
- 540- "Oxygen" all tank sizes
 - 300- "Large" 60-400 cu. ft
 - 350- Hydrogen
 - 510- "Large" 60-400 cu. ft. internal threads

ITEM #	DESCRIPTION	CYL. TYPE
55-1121	35-125-540 OXYGEN	CGA540 (B) RH
55-1122	35-15-300 ACETYLENE	CGA300 (B) LH
55-1123	35-15-510 ACETYLENE	CGA510 (B) LH
55-1124	H1432B-350 HYDROGEN	CGA350 (B) LH

"B"- 1/16" - 18 THREADS

8. Preset Regulators for Disposable Tank

These regulators are with "B" fitting for use on disposable tanks. Designed to provide dependable control for fuel and oxygen delivery. Do not use these regulators on full size tanks.



ITEM #	DESCRIPTION
55-1131	249-499 OXYGEN / "B" FITTING
55-1132	249-500 PROPANE / "B" FITTING



10. Regulator Check Valves

A device that primarily controls the flow direction of fuel or oxygen. In line connection is recommended for increased safety. These check valves should be installed between the regulator and the hose. Both have $\frac{9}{16}$ " connections.



ITEM #	GAS
55-1161	OXYGEN $\frac{9}{16}$ " -RH
55-1162	FUEL $\frac{9}{16}$ " - LH

12. Flashback Arrestors

- Built-in check valve helps prevents the reverse flow of gas
- Requires no manual reset
- Attaches to standard "B" fittings
- High quality brass construction
- Sintered stainless steel filter help stops flashback fire
- UL listed



ITEM #	DESCRIPTION
55-1165	H753 REGULATOR MOUNT (OXYGEN AND FUEL GAS PAIR)
55-1166	H743 TORCH MOUNT (OXYGEN AND FUEL GAS PAIR)

11. Two Hose Manifolds

Allows you to operate one or two torches from a single tank. Separate manifolds must be used for fuel and oxygen. Gas flow is controlled by individual needle valves.



ITEM #	DESCRIPTION
55-1171	FOR OXYGEN $\frac{9}{16}$ " RH
55-1172	FOR FUEL $\frac{9}{16}$ " LH

13. Hose Connectors

Solid, one piece brass connections with nozzle to fit the respective hose size. Thread connections for fuel and oxygen.



ITEM #	DESCRIPTION
55-1176	OXY RH - $\frac{9}{16}$ " FOR $\frac{1}{4}$ " ID. HOSE
55-1178	FUEL LH - $\frac{9}{16}$ " FOR $\frac{1}{4}$ " ID. HOSE

Cylinder Connection Information

(CGA Number Designations)

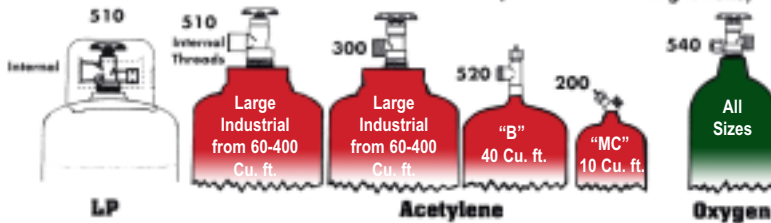

The user is cautioned to shut off gas first at the torch and then at the regulator

Important Note for Gas Safety

- Consult your gas supplier before setting up the tank and torch system
- Ensure that the installation conforms to state and local regulations
- Secure fuel tanks to reduce risk of damage from falling or explosion
- Get professional help for all gas fittings and maintenance
- Purge fuel and oxygen lines and shut off main tanks daily after use
- Always use eye protection and work in a well ventilated area

14. Empty Cylinders and Tanks

These tanks are standard for most jewelry manufacturers. All tanks are tested, but sold empty due to federal regulations. Tanks may be filled by your local gas or welding supply company.

ITEM #	DESCRIPTION	DIMENSIONS	WT.
55-1151	OXYGEN CYLINDER 20 CF	17 $\frac{1}{2}$ " HT. X 5" Ø	12 LBS
55-1152	ACETYLENE- "MC" 10 CF	15" HT. X 4" Ø	8 LBS
55-1153	PROPANE 5 LB	9" HT. X 8" Ø	6 LBS





15. Acetylene Air Kit

A mid sized kit for all jewelry soldering, brazing, annealing and small melting jobs. No oxygen needed. Produces 1500°C flame temperature. Tank is not included, but is available separately.

55-1181 Kit includes torch handle, super fine tip **NE180-00**, 12 $\frac{1}{2}$ ' of covered hose, regulator with gauge and lighter. (Tank not included)

55-1182 Silver Smith torch handle is for air/fuel use. Crafted in all metal construction with long wearing precision brass parts that are nickel plated for heat resistance and durability.



55-1181

ITEM #	DESCRIPTION
55-1181	239-193 SILVERSMITH ACETYLENE KIT - B TANK
55-1182	NE180A SILVERSMITH ACETYLENE TORCH HANDLE
55-1184	RL121 12 $\frac{1}{2}$ ' HOSE



#4 for heavy soldering and heating

#3 for light brazing and silver soldering

#2 for all types of soft soldering

#1 for fine instrument work

#0 for jewelry and small tube soldering

#00 for jewelry and electronic soldering

16. Air Acetylene Tips

- Reliable, precision threaded, interchangeable tips for torch
- No wrench needed. Tips are hand tightened
- 360° tip turning radius
- Different orifices for fine soldering or brazing
- Tips are 100% flame tested and UL listed

Spare brass nozzle for tips available on order.

ITEM #	SIZE	FLAME OPENING
55-1191	NE180-4 #4- EX-LARGE	$\frac{3}{8}$ " / 10MM
55-1192	NE180-3 #3- LARGE	$\frac{1}{4}$ " / 6MM
55-1193	NE180-2 #2- MEDIUM	$\frac{3}{16}$ " / 5MM
55-1194	NE180-1 #1- SMALL	$\frac{9}{64}$ " / 3.6MM
55-1195	NE180-0 #0- FINE	$\frac{15}{16}$ " / 2.4MM
55-1196	NE180-00 #00 - SUPER FINE	$\frac{21}{32}$ " / 1.7MM

Maximum Fuel Temperatures

ACETYLENE: 5900-6300 °F	NATURAL GAS: 4600 °F
BUTANE: 4995° F	PROPANE: 4870 °F
MAPP®: 5300° F	HYDROGEN: 4850 °F

Characteristics of Fuel Gas

- *High Pressure (HP) Gases: Acetylene and Hydrogen*
- *Low Pressure (LP) Gases : Propane, MAPP®, Natural gas and Butane*

GENERIC NAME	TRADE NAME
Acetylene	—
Methylacetylene-Propadiene (MPS)	MAPP®
Propane, Propane-Based Mixtures	Propane-butane, Flamx, Acetogen, Florida Industrial Gas, Hy-Temp, Fuel Gas, I.G. Gas, Chem-Gas
Propylene	HPG, Apachi, B-Plus, Chem-O-Lene, Gulf HP gas, HEF, B.T.U., Liquifuel
Natural Gas (Methane)	Natural Gas, City Gas



17. Smith Casting Melting Torch

Medium duty torches have silver brazed joints to provide overall strength and rigidity for safe performance under rugged conditions. UL listed. The torch body is made of nickel plated solid brass, with stainless steel ball valves for positive sealing and precision control. Torch handle WH100 is suitable for all heating and melting tips. Tip heads are made of solid copper. Multi flame rose bud tips are designed from heavy wall copper. It is recommended to use a flashback arrestor on the welding system. All items are to be ordered separately.

ITEM #	DESCRIPTION
55-1201	WH100 Smith casting torch handle with stainless steel ball valves for positive shut off, Teflon seals for smooth adjustment
55-1204	MT603 Medium duty Acetylene multi flame heating tip - 6 orifice Overall length 10"
55-1205	MT605 Medium duty Acetylene multi flame heating tip - 6 orifice Overall length 16"
55-1206	MW210 Single flame Oxygen / Acetylene Casting Tip
55-1207	MW411 Single flame Oxygen / Propane/ Natural gas Casting Tip
55-1166	H743 Flashback Arrestor (oxygen and fuel gas pair)

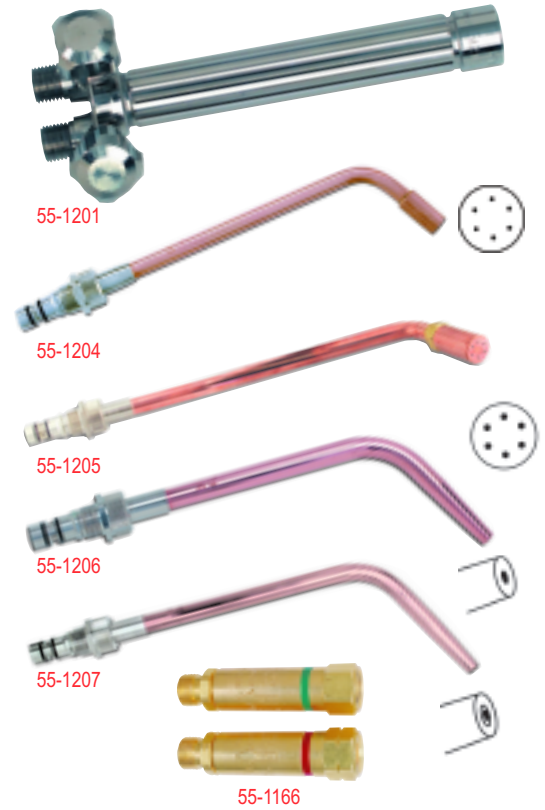

18. Dual Hose

Maximum working pressure
 Oxygen.....150 PSIG maximum Acetylene.....15 PSIG maximum
 Propane, MAPP® and all other fuel gases40 PSIG maximum

ITEM #	DESCRIPTION
55-1145	RL921 12½' length 3/8" ø "B-B" fitting 3/8"-18" wt. 6½ lbs Red-Acetylene, Green-Oxygen, -conn. both ends "B-B"
55-1146	RA921 12½' length 3/8" ø "B-A" fitting 3/8"-18" wt. 2½ lbs Red-Acetylene, Green-Oxygen, -conn. one end "B" & other end "A"
55-1147	TRL921 12½' length 3/8" ø "B-B" fitting 3/8"-18" wt. 2¾ lbs Red- Propane, Green- Oxygen, -conn. both ends "B-B"



Oxygen / Fuel Fittings

- "A" Type Fitting are 3/8"
- "B" Type Fitting are 1/2"
- Fuel fittings are LH threads • Oxy fittings are RH threads

19. Combustible Gas Alarm

Small compact electronic sensor that needs to be placed near the source of a potential gas leak. Helps detect combustible gases, natural, LP, propane and butane. Audible alarm similar to smoke buzzer.



ITEM #	DESCRIPTION
55-1274	GAS ALARM 110V

20. Gasaver

Eliminates gas wastage during torch start up/shut down and between flame applications. Ideal for brazing, welding and production applications. UL listed.

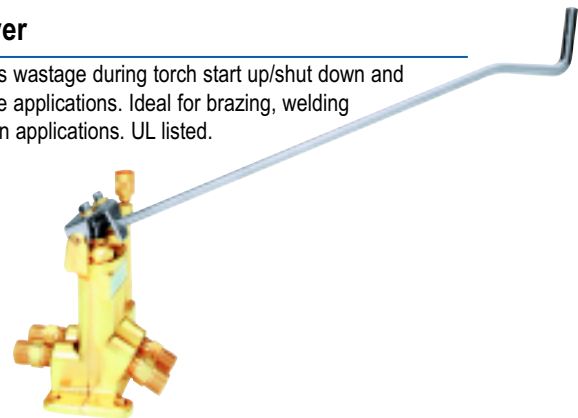

ITEM #	DESCRIPTION
55-1275	WDW101 ACETY / OXY
55-1276	WDW104 PROPANE



21. Harris Melting Kits

An ideal melting torch for large amounts of gold, silver and metal alloys but only small amounts of platinum. Heavy duty, all brass body, with a check valve safety feature to help prevent the reverse flow of gases. Leak proof valves for improved safety and reliability. Supplied with one large single orifice melting tip, tested and inspected. All torches are UL listed.



ITEM #	DESCRIPTION
55-1211	HARRIS MELTING TORCH
55-1212	REPLACEMENT TIP #30N

22. HOKE Type-Jewel Torch & Adapter Kits

A professional jeweler's torch for all soldering, brazing, welding and melting tasks. Each torch is made for a specific oxy-fuel combination. Forged solid brass body with seamless tubing, all nickel plated for long lasting service. Conveniently positioned finger tip control of valves for precision mixing of gases. Models with a pilot lamp allow a continuous flow of gas for instant ignition.

Adapter Tips: Tips are of special design to give a non-oxidizing flame for cleaner soldering and brazing. Excellent for intricate work on chains, rings, pendants and delicate jewelry. Not recommended for use with acetylene.



ITEM #	DESCRIPTION	PILOT	TIPS
55-1221	OXYGEN & ACETYLENE	NO	4
55-1222	OXYGEN & ARTIFICIAL GAS	YES	4
55-1223	OXYGEN & BUTANE OR PROPANE	NO	4
55-1224	OXYGEN & NATURAL GAS	NO	3
55-1225	ADAPTER TIPS- SET OF 6		6



23. HydroGem

A state-of-the-art system. The HydroGem provides increased safety, as there is no stored gas. These machines use electricity to break down distilled water to create a clean fuel source. HydroGem comes complete with one torch and tip set, flexible hose, atomizer and necessary gauges. The needle tip torch flame may be used for soldering, brazing, welding or melting. Flame temperatures from 1500-3300°C. Working delivery pressure is low and the built-in flashback arrestor is designed to help stop any accidental burning of the gas back down the tube to the machine. Manufactured from the finest materials to stringent standards for long lasting service. Operating instructions are included. Meets all current CE requirements. Wt. 110 lbs.

ITEM #	DESCRIPTION
55-1251	HYDROGEM COMPLETE SET

24. Torch Mate Lighters

A convenient table top model widely used by professional jewelers. Battery (included). Add a torch mate holder for convenience.

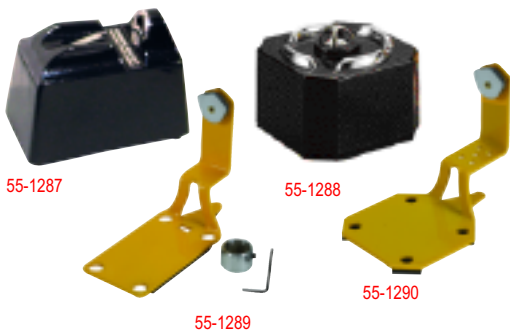

ITEM #	DESCRIPTION
55-1287	TORCH MATE LIGHTER
55-1288	TORCH MATE II BLACK
55-1289	TORCH MATE HOLDER FOR 55-1287
55-1290	TORCH MATE HOLDER FOR 55-1288



25. Torch Lighter & Flint

A safer means to produce a quick spark, to ignite gas torches, without the hazard of an open flame.



ITEM #	DESCRIPTION
55-1261	LIGHTER & FLINT
55-1262	FLINT BOX OF 12

26. Torch Holder-Deluxe

A universal positioning free standing torch holder to assist soldering operations.

ITEM #	DESCRIPTION
50-1023	TORCH HOLDER ONLY

Torch holder is to be used with third hand base
50-1021 see page #45



(Torch is not included)

27. Bench Torch Holders

Two types of torch holders, one clamps and the other screws on to the jeweler's workbench.



55-1293

ITEM #	DESCRIPTION
55-1292	CLAMP TYPE
55-1293	SCREW TYPE



55-1292

28. Safety Goggles for Platinum

Light plastic wrap-around frames with safety colored lenses help protect eyes when melting metal, soldering or brazing.



ITEM #	DESCRIPTION	SHADE
45-1021	SAFETY GOGGLES	3A
45-1022	SAFETY GOGGLES	4A
45-1023	SAFETY GOGGLES	5A
45-1024	SAFETY GOGGLES	7A
45-1025	SAFETY GOGGLES	10A

29. Valve Assemblies

Replacement valve assemblies for the Little Torch. The green is for the oxygen port and the red is for the fuel port.

Do not interchange these assemblies.



ITEM #	DESCRIPTION
55-1027	OXYGEN VALVE - GREEN 7345
55-1028	GAS VALVE - RED 7346

30. Magnetic Torch Stand

A metal weighted base with storage for tips # (2-7) and a magnetic mount to securely hold the Little Torch. (Torch and tips are not included)



ITEM #	DESCRIPTION
55-1291	MAGNETIC TORCH STAND

31. Butane Torches

Solid state, trigger ignition melter uses clean burning fuel for on-the-spot work. Adjustable flame temperature up to 2500°F. Ideal for heating wax working tools and smoothing wax models. Unit may be refilled.



55-1281



55-1282



55-1283

ITEM #	DESCRIPTION
55-1281	26 G FUEL
55-1282	14 G FUEL
55-1283	BUTANE REFILL- 9 OZ

32. Smoothy Flameless Wax Finisher

Pencil point torch of heated air. Ideal for blending uneven surfaces without actually touching the wax. Uses butane fuel. When the tip is removed it may be used as a mini torch for light soldering and repair work.

Temp. 2300°F/1260°C.
UL listed.



ITEM #	DESCRIPTION
59-1625	FLAMELESS WAX FINISHER



33. The EZ Torch

The EZ Torch is a simple inexpensive torch for craftwork, general repair, soldering and annealing. The torch uses propane as fuel from a disposable or refillable tank and atmospheric oxygen. An adjustable valve replaces the more expensive gas regulator and delivers a perfectly controlled stable flame.

55-1231: Includes torch body and hose, three tips(55-1233/1234/1235) with valve for disposable propane tank. Tank to be ordered separately.

55-1232: Includes torch body and hose, three tips (55-1233/1234/1235) with valve for small refillable propane tank. Tank to be ordered separately.



ITEM #	DESCRIPTION
55-1231	EZ-TORCH KIT FOR DISPOSABLE PROPANE TANK
55-1232	EZ-TORCH KIT FOR SMALL REFILLABLE PROPANE TAKS
55-1233	SMALL TIP
55-1234	MEDIUM TIP
55-1235	LARGE TIP
55-1238	VALVE ASSEMBLY FOR DISPOSABLE PROPANE TANKS
55-1239	VALVE ASSEMBLY FOR SMALL REFILLABLE PROPANE TANKS
55-1241	EZ TORCH BODY ONLY
55-1242	REPLACEMENT HOSE
55-1243	REPLACEMENT KNOB

34. The Swiss Torch

Manufactured in Switzerland. This torch similar to the hoke style is most popular with jewelers for its precision and versatility. The torch may be used for repair, microwelding and precise soldering. It is also a platinum torch, when used with a special tip it produces a hot flame for melting or casting small amounts of platinum.

Brazing Tips: Provide excellent flame stability even with natural gases (except acetylene). Small pointed flame 4900°F-5160°F.

Microflame Welding & Brazing Tips: Extremely maneuverable flame, unlimited flame position. Adjustable pointed flame 4900°F-5160°F.

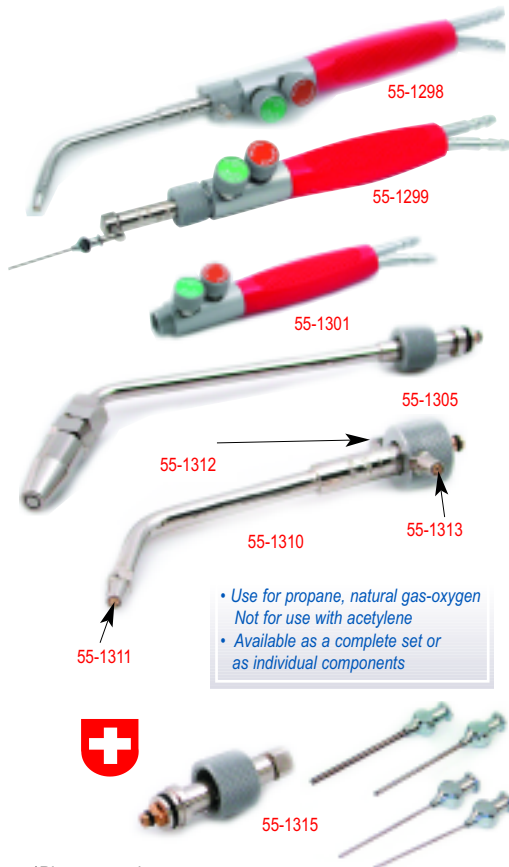

55-1298: Swiss Torch Set
(Torch body 55-1301 Hoke style head three tips 55-1310)

55-1299: Swiss Torch Set
(Torch body 55-1301 Microhead with four needle heads 55-1315)

ITEM #	DESCRIPTION
55-1301	TORCH HANDLE
55-1302	WELDING AND BRAZING TIP*
55-1303	BRAZING, HEATING AND MELTING TIP*
55-1304	HEATING AND MELTING - BUSHY FLAME TIP*
55-1305	HEATING AND MELTING - PLATINUM HEAD
55-1310	HOKE STYLE HEAD WITH 3 TIPS
55-1311	HOKE STYLE TIP #1- FINE
55-1312	HOKE STYLE TIP #2- MEDIUM
55-1313	HOKE STYLE TIP #3- LARGE
55-1315	MICROFLAME WELDING AND BRAZING TIP WITH 4 NEEDLES
55-1316	MICROFLAME- SET OF NEEDLES #1-#4
55-1317	MICROFLAME- NEEDLE #1
55-1318	MICROFLAME- NEEDLE #2
55-1319	MICROFLAME- NEEDLE #3
55-1320	MICROFLAME- NEEDLE #4

• Use for propane, natural gas-oxygen
Not for use with acetylene
• Available as a complete set or
as individual components

*Picture not shown



TWEEZERS

■ Boley Style Tweezers	311
■ Ceramic Tweezers	310
■ Cross Lock Tweezers	312
■ Cyber-therm Tweezers	311
■ Diamond Tweezers- Swiss	308
■ Diamond Tweezers- Value	312
■ General Purpose Tweezers-Swiss	310
■ General Purpose Tweezers-Value	311
■ Head & Shank Tweezers	310
■ Pearl Holding Tweezers	309
■ Ring Holding Tweezers	311
■ Solder Free Tweezers	310
■ Soldering Tweezers	312
■ Spring Grip Tweezers	311
■ Starlight- Diamond Tweezers	309
■ Teflon Grip Tweezers- Swiss	309
■ Titanium Diamond Tweezers	309

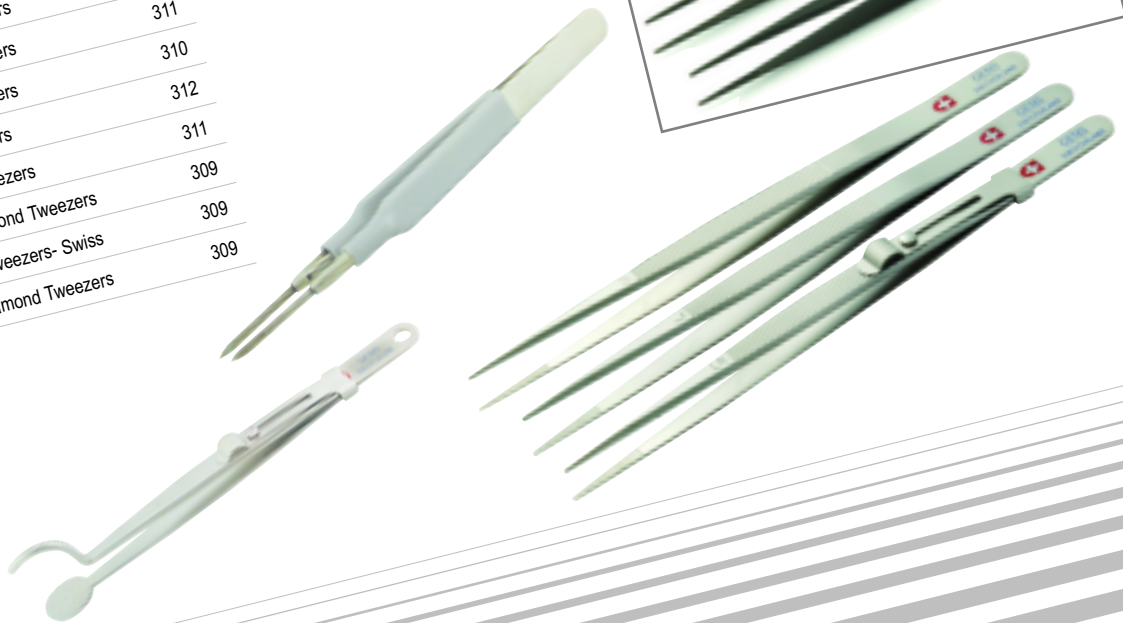
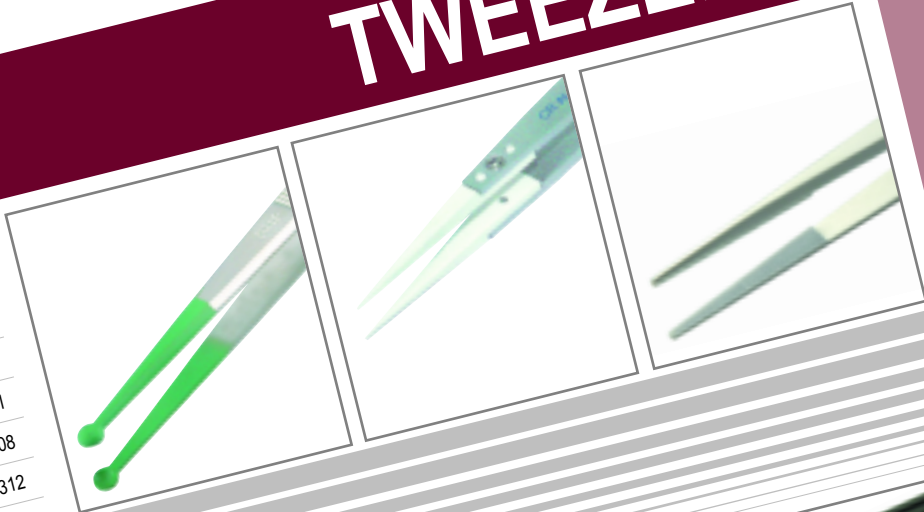

Techniques of Jewelry Illustration and Color Rendering

by **Adolfo Mattiello**

Beautifully illustrated guide to jewelry rendering. Some of the best jewelry designers in the field explain and demonstrate the illustration process.

61-1013 (Hardcover – 152 pages)

TWEEZERS



1. Diamond Tweezers

Absolutely the best and the finest made tweezers specifically for the professional jeweler. Select from a wide range of stainless matte or black finish. Inside grooved or serrated tips, with or without a locking mechanism. Overall length 160mm.

			ITEM #	TYPE
	MATTE FINISH	REGULAR	56-1011	XF
			56-1012	F
			56-1013	M
			56-1014	L
			56-1015	XL
	BLACK	REGULAR	56-1021	XF
			56-1022	F
			56-1023	M
			56-1024	L
			56-1025	XL
	MATTE FINISH	LOCK	56-1032	FR
			56-1033	MR
			56-1034	LR
			56-1035	XLR
	BLACK	LOCK	56-1042	FR
			56-1043	MR
			56-1044	LR
			56-1045	XLR
	MATTE FINISH	GROOVED	56-1053	M1
			56-1054	L1
			56-1055	XL1
			56-1056	XXL1
	BLACK	GROOVED	56-1063	M1
			56-1064	L1
			56-1065	XL1
			56-1066	XXL1
	MATTE FINISH	LOCK - GROOVED	56-1073	MR1
			56-1074	LR1
			56-1075	XLR1
	BLACK	LOCK - GROOVED	56-1083	MR1
			56-1084	LR1



TWEEZERS

2. Starlight- Diamond Tweezers



Starlight tweezers have a fine granulated coating which firmly holds small or large stones at any angle. Starlight titanium tweezers are lighter than Starlight diamond tweezers, yet twice as strong. Overall length 160mm.

XF	EXTRA FINE	0.4	FR	FINE LOCK	0.6	M1	MEDIUM GROOVED	0.9
F	FINE	0.6	MR	MEDIUM LOCK	0.9	L1	LARGE GROOVED	1.2
M	MEDIUM	0.9	LR	LARGE LOCK	1.2	XL1	X-LARGE GROOVED	1.8
L	LARGE	1.2	XLR	EXTRA LARGE	1.8	XXL1	XX-LARGE GROOVED	2.4
XL	EXTRA LARGE	1.8	MR1	MEDIUM GRVED. LOCK	0.9			
			LR1	LARGE GRVED. LOCK	1.2			
			XLR1	X-LARGE GRVED. LOCK	1.8			



STARLIGHT

REGULAR



STARLIGHT

LOCK



ITEM #	TYPE
56-1111	XF
56-1112	F
56-1113	M
56-1114	L
56-1115	XL
56-1122	FR
56-1123	MR
56-1124	LR

3. Titanium Tweezers



Super lightweight rust resistant tweezers, excellent for sorting and inspecting stones. 100% non-magnetic. Overall length 160mm.

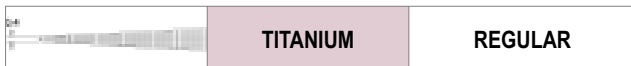

TITANIUM

REGULAR



STARLIGHT		REGULAR	
ITEM #	TYPE	ITEM #	TYPE
56-1141	XF	56-1131	XF
56-1142	F	56-1132	F
56-1143	M	56-1133	M
56-1144	L	56-1134	L
56-1145	XL		

4. Teflon Tweezers- Swiss



Top quality Swiss tweezers with teflon coated tips, particularly good for showing diamonds and handling precious gems. Length 6 1/2".

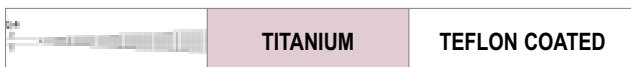

TITANIUM

TEFLON COATED



ITEM #	TYPE
56-1181	TEFLON

5. Pearl Holding Tweezers



Made of carbon steel, nickel plated, with special shaped cup ends coated with teflon for protection while handling precious pearls. Length 6 1/2".



PEARL HOLDING

REGULAR



ITEM #	TYPE
56-1183	PEARL



6. Ceramic Tweezers

High quality, non-magnetic, anti-static, light weight aluminum body tweezers. Indispensable when soldering or working with platinum jewelry.

	CERAMIC	TIP
--	---------	-----



ITEM #	TYPE
56-1146	CERAMIC
56-1147	TIP



7. Head & Shank Tweezers

Made of stainless steel with a serrated base and slide lock. Ideal for holding shanks and settings in position while soldering.

	HEAD & SHANK	LOCK
--	--------------	------



ITEM #	TYPE
56-1151	DELUXE



8. Solder Free Tweezers

Swiss made, anti-magnetic, acid resistant tweezers that can be dipped in flux. Solder will not adhere to the ends.

	SOLDER FREE	REGULAR
--	-------------	---------



ITEM #	SIZE
56-1158	6 1/2"



9. General Purpose Tweezers

Stainless steel, non magnetic, satin finish tweezers for handling all miniature parts. They have tapered shanks, beveled edges and matched points that have been honed.

	TITANIUM	REGULAR
--	----------	---------



ITEM #	STYLE
56-1153	#3

	SPECIAL POINTS	STAINLESS STEEL
--	----------------	-----------------



56-1161



56-1163



56-1167



56-1165

ITEM #	STYLE
56-1161	#1
56-1163	#3
56-1165	#5
56-1167	#7



10. Boley Style Tweezers



Premium quality tweezers. Made of stainless steel. Useful for handling very fine parts.

AA - tapered and sharp point.
MM -Tapered beveled fine point

**BOLEY
STYLE- SWISS**

**STAINLESS STEEL OR
NICKEL PLATED**



ITEM # STYLE

56-1171 AA(SS)

56-1172 AA(NI)

56-1173 MM(SS)

56-1174 MM(NI)

11. Cyber-therm Tweezers- Japan

Unique tungsten steel alloy withstands temperature up to 3000°C for 5-10 minutes. Handles protected by heat resistant rubber insulating sleeves.

CYBER -THERM

REGULAR



ITEM # SIZE

56-1148 145MM

12. General Purpose Tweezers- Value

Stainless steel, non magnetic, satin finish tweezers for handling all miniature parts. They have tapered shanks, beveled edges and matched points that have been honed.

**GENERAL
PURPOSE-VALUE**

STAINLESS STEEL



56-1211



56-1215



56-1217



56-1213

56-1211 #1

56-1213 #3

56-1215 #5

56-1217 #7

AA - tapered and sharp point.
MM -Tapered beveled fine point
GG - pointed indented shank.
RR -heavy duty with wide shank.

**BOLEY
STYLE-VALUE**

**STAINLESS STEEL OR
NICKEL PLATED**



56-1221 AA(SS)

56-1222 AA(NI)

56-1223 MM(SS)

56-1224 MM(NI)

56-1225 RR(SS)

56-1226 RR(NI)

56-1227 GG(SS)

56-1228 GG(NI)

*For Steam Tweezers
see page #105*

13. Ring Holding Tweezers- Value

Secures rings from the inside to enable soldering of the shank ends. Also useful for holding two rings to solder.



ITEM # DESCRIPTION LENGTH

56-1231 RING HOLDING TWEEZER 5³/₁₆"

14. Spring Grip Tweezers- Value

Spring grip brass tweezers are useful for sand blasting, pen plating and inspection. Made of solid brass with rubber coating. Points are bent to secure work.







ITEM # DESCRIPTION LENGTH

56-1234 SPRING GRIP 9¹/₂"







15. Soldering Tweezers- Value

Cross locking stainless steel tweezers with serrated tips and fiber handles, to protect hands from heat when soldering. Overall length 6³/₄".

	TIP	STYLE	ITEM #
		STRAIGHT	56-1241
		BENT	56-1242

16. Cross Lock Tweezers- Value

Self locking tweezers that are ideal for use in the Third Hand for soldering. Different types of jaws to suit special applications.

	TYPE	SIZE	ITEM #
	POINTED	4 ³ / ₄ "	56-1251
	POINTED	6 ¹ / ₂ "	56-1252
	BLUNT	6 ¹ / ₂ "	56-1253
	FREE STANDING	6 ¹ / ₄ "	56-1254

17. Diamond Tweezers- Value

Made of the finest materials. Suitable for sorting, inspecting, and handling of diamonds. Features locking and non-locking, various types of points, fine to large, finished matte or black.

	TYPE	STYLE	ITEM #
	FINE	MATTE	56-1261
	MEDIUM	MATTE	56-1262
	LARGE	MATTE	56-1263
	EX-LONG	MATTE	56-1266
	FINE	BLACK	56-1271
		MEDIUM	BLACK
	LARGE	BLACK	56-1273
	MEDIUM-LOCK	MATTE	56-1281
	MEDIUM-LOCK	BLACK	56-1282
	GROOVED	MATTE	56-1291
	SHOVEL	MATTE	56-1292
	HEAD & SHANK	S.S	56-1295



VICES

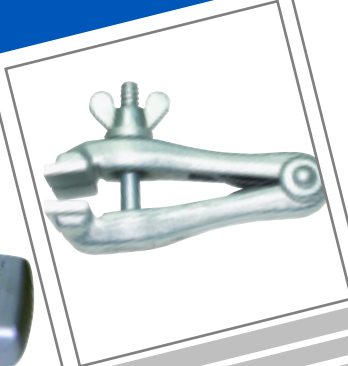

- Double-Ended Pin Vise with Collets 314
- Hand Vise Plier 314
- Hand Vise with Wing Nut 314
- Lowell Pattern Hand Vise 314
- Sliding Pin Vise 314
- Square Chuck Pin Vise 314
- Steel Hand Vise 314
- Swivel Head Pin Vise 314
- Wood handle Pin Vise 314



 **ikohe**



Jewelry: Fundamentals of Metalsmithing by **Tim McCreight**

Clear and insightful instruction on jewelry making methods for the beginner or intermediate metalsmith. Features various techniques including fabricating, surface treatments, joining, finishing, stone setting, chain making, mechanisms and casting. Color photos of finished pieces are used to demonstrate each technique.

BK-416 (Hardcover – 143 pages)



1. Swivel Head Pin Vise

Reversible collet in one pin vise with a screw chuck.
0-1/8" capacity -3 1/2" long



ITEM #	SIZE
57-1011	0-1/8"

2. Wood Handle Pin Vise

Economical steel pin vise chuck with hardwood fluted handle. Overall length 102MM.



57-1012	0-1.19MM
---------	----------

3. Double-Ended Pin Vise with Collets

Pin vise with steel collets of different sizes mounted at both ends.



57-1013	0-2.5MM
---------	---------

4. Square Chuck Pin Vise

Vise with two steel chucks and a spare chuck held in hollow brass handle.



57-1021	70MM
57-1022	80MM
57-1023	90MM
57-1024	100MM
57-1025	110MM

5. Sliding Pin Vise

Slide lock pin vise is easy to operate with one hand.



57-1031	0-1.5MM
---------	---------

6. Double Ended Pin Vise -France

Hexagon head vise with reversible steel collets at each end.



57-1041	0 - 0.125"
---------	------------

7. Hand Vise with Wing Nut

57-1051: 5/8" wide jaw hollow handle jaws open max. 1/4".
57-1052: Pointed nose hollow handle jaws open max. 1/4".



57-1051	0-2.5MM
57-1052	0-2.5MM

8. Lowell Pattern Hand Vise

Hollow handle and grooved corrugated jaws that open and close by turning the handle. Holds long wire pieces. Width of jaws 1/2".



44-1028	120MM
---------	-------

9. Steel Hand Vise -German

Spring action vise with serrated jaws.
57-1061: Jaw measures 1 1/8" wide overall length 4".
57-1062: Jaw measures 1 1/2" wide overall length 5".



57-1061	1"
57-1062	1.5"

10. Hand Vise Plier -German

Hardened steel, serrated jaw vise with a quick lock system. Jaw size 1" X 5/8". Max. Opening 5/8".



57-1071	70MM
---------	------



WATCH TOOLS

■ B & L® Watch Makers - Loupes	321
■ Ball Pein Hammers	320
■ Band Vise	317
■ Bergeon® Case Opener-Rolex Watches	316
■ Bergeon® Crystal Press-5500-C	316
■ Bergeon® Jaxa Case Wrench-2819-4	316
■ Bergeon® Key for Opening Watches	316
■ Bergeon® Micro-Shock Case Opener	319
■ Bergeon® Plier Type Pin Remover	316
■ Bergeon® Watchmakers Screwdrivers	316
■ Bergeon® Waterproof Tester	316
■ Bracelet Holder / Plier	317
■ Bracelet Shear	318
■ Case / Movement Holder	318
■ Case Closing Plier	319
■ Case Holder Bench Type	319
■ Case Knife Opener	320
■ Case Opener - Crab Type	319
■ Case Press	320
■ Case Wrench	318
■ Crystal Cement	321
■ Crystal Remover	320
■ Deluxe Spring Bar Remover	317
■ Deluxe Link Pin Remover	317
■ Economy Eye Loupe	321
■ Elma Leak Controller	322

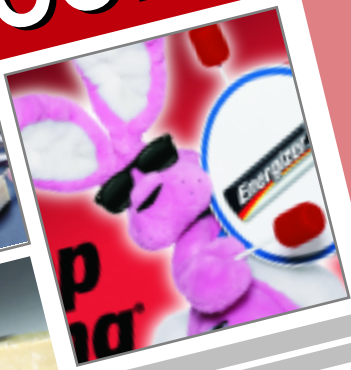

■ Elma® Watch Cleaning Machine	322
■ Elma® Watch Servicing Unit	322
■ Elma® Watch Winder- Box Type	322
■ Energizer® Batteries	323-324
■ Hand Remover- Plunger Type	320
■ Lever Type Case Press- France	319
■ L-G "OpenAll" Case Wrench	319
■ L-G Master Case Opener	318
■ MKS Battery Charge Tool Set- Japan	322
■ MKS Case Opener V-type- Japan	318
■ MKS Dust Blower -Japan	321
■ MKS Pocket Size Case Opener	319
■ MKS Special Watch Vise- Japan	322
■ Multi Purpose Pin Press	318
■ Polywatch Scratch Remover	321

■ Quartz Movement Cleaner	321
■ Rolex Case Opener	318
■ Screw Type Link Pin Remover	317
■ Screwdriver Sets	320
■ Spring Bar Tools	317
■ Spring Bars - Assorted Sets	322
■ Strap Notchers	317
■ Vise for Waterproof Watches	320
■ Watch Cleaning Machine	321
■ Watch Hand Remover- Presto	320
■ Watch Maker Hammers	321
■ Watch Tissue Paper	321
■ Watch Winders	322
■ Western Products	321

ikohe



Energizer



BERGEON

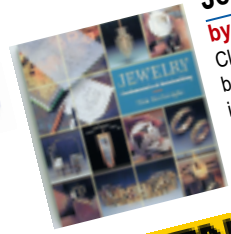

Jewelry: Fundamentals of Metalsmithing by Tim McCreight

Clear and insightful instruction on jewelry making methods for the beginner or intermediate metalsmith. Features various techniques including fabricating, surface treatments, joining, finishing, stone setting, chain making, mechanisms and casting. Color photos of finished pieces are used to demonstrate each technique.

61-1076 (Hardcover - 143 pages)



BERGEON 1. Crystal Press

- Compact die cast alloy press
- Relief to allow the insertion of watches with bracelets
- Crystals may be fitted with or without a tension ring

*5500A set includes:

Press, 9 lower stakes-bakelite, 9 lower stakes-duraluminum15-33mm, 12 reversible stakes 15-45mm, one universal lower stake and one lower support. (picture not shown)

5500C set includes:

Press, 9 lower stakes-bakelite, 9 lower stakes-duraluminum18-34mm, one universal lower stake.



58-1005

ITEM #	DESCRIPTION
58-1004	WATCH CRYSTAL PRESS- 5500A*
58-1005	WATCH CRYSTAL PRESS- 5500C

BERGEON 2. Case Opener-Water Proof Cases-5700Z

- High quality die-cast alloy construction
- Precision vise with set of dies

5700Z Set Includes:

- 12 Chucks for cases
- Four pairs of case holding jaws
- Nine round suction heads
- One superior vise and four screws
- Dimensions 250 x 95 x 300mm ht.
- Wt. 2.95 kg

5700-RO Set Includes:

- Case vise with non-mar plastic posts
- Set of six rings with adapters
- Sizes 18.5, 20.2, 22.5, 26.5, 28.3, 29.5mm
- One pair of set screws with wing nuts
- Movement holder
- Dimensions 140 x 160 x 300mm ht. • Wt. 3 kg



58-1009

58-1013

ITEM #	DESCRIPTION
58-1009	UNIVERSAL CASE OPENER -5700Z
58-1012	ASSORTED SET-SIX DIES FOR ROLEX 5538
58-1013	WISE WITH FOUR PINS - 5674
58-1011	ROLEX CASE OPENER -5700-RO*

(*picture not shown)

BERGEON 3. Watchmakers Screwdrivers-3044-A

- Swiss made premium quality
- Precision chrome plated screwdrivers
- Very stable base on non-slip rubber
- Rotating base 90mm dia.
- 10 Screwdrivers (0.50, 0.60, 0.80, 1.00, 1.20, 1.40, 1.60, 2.00, 2.50, 3.0 mm)
- Replaceable blades in gray plastic tube
- Wt. 0.93 kg



ITEM #	DESCRIPTION
48-1076	SET OF 10 PCS WITH STAND

BERGEON 4. Jaxa Case Wrench-2819-4

- Precision tool for professional use
- Chrome plated handle and body
- Includes four sets of pins that may be removed and replaced
- Ideal for fitting unbreakable crystals
- Comes with a plastic case
- Wt. 0.26 kg



ITEM #	DESCRIPTION
58-1017	JAXA CASE WRENCH

BERGEON 5. Waterproof Tester-5555/98

- A testing device for watches without letting water into the case
- This guarantees the customer the water resistance of the watch
- Stable cast metal base
- Plexiglass chamber with double seals
- Test up to 6 ATM max.
- Capacity- 2 watches
- Dimensions 245 x 115 x 310 mm
- Wt. 3.5 kg



ITEM #	DESCRIPTION
58-1021	WATERPROOF TESTER

BERGEON 6. Key for Opening Watches-5537

- Swiss made case wrench
- Six precision chucks to fit Oyster case backs
- Sizes 18.5, 20.2, 22.5, 26.5, 28.3 and 29.5 mm



ITEM #	DESCRIPTION
58-1016	KEY FOR OPENING WATCHES

BERGEON 7. Plier Type Pin Remover- 6819

- The most effective tool for inserting and removing pins
- Plastic support prevents damage to the band
- Pliers may be adjusted to fit different size bands
- Set includes two pin plungers 0.75 and 0.85mm
- Wt. 0.3 kg



ITEM #	DESCRIPTION
58-1024	PIN REMOVER



WATCH TOOLS & SUPPLIES

8. Spring Bar Tools

Three different tools for spring bar insertion and removal. Precision made in tempered steel.



ITEM #	DESCRIPTION
58-1041	SPRING BAR-POINT
58-1042	SPRING BAR-VEE
58-1043	SPRING BAR-VALUE

9. Notching Plier-Strap/Solder

Ideal tool for notching leather straps. Box joint, spring loaded with a comfortable grip. Overall length 5"/130mm.



ITEM #	DESCRIPTION
41-1252	NOTCHING PLIER

10. Deluxe Link Pin Remover

Easy pin extraction by fine controlled screw knob. The base adjusts to suit bands of different thickness. Includes three spare steel pins.



ITEM #	DESCRIPTION
58-1066	LINK PIN REMOVER
58-1068	REPLACEMENT PIN

11. Spring Bar Tool- Reversible Points

Made in tool steel hardened and tempered. One straight end and one forked. Millimeter gauge for measurement between lugs.



ITEM #	DESCRIPTION
58-1051	SPRING BAR TOOL
58-1052	POINTED TIP
58-1053	FORKED TIP

12. Band Vise

Convenient one piece molded vise. Adjustable to fit any size of bracelet or watch band. Non-mar jaws for a firm grip.



ITEM #	DESCRIPTION
58-1064	BAND VICE

13. Bracelet Holder with Pins

Made of high impact plastic, the bracelet holder has grooves of different widths. The base provides ample support for removing screws or pins. Includes a set of pins of varying diameters.

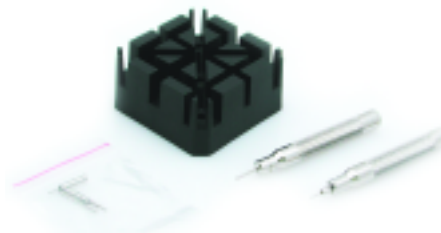

ITEM #	DESCRIPTION
58-1071	BRACELET HOLDER
58-1072	SPARE PIN 0.80MM
58-1073	SPARE PIN 1.00MM

14. Deluxe Spring Bar Remover

Fine finished stainless steel body with reversible tips. Ideal for removing and inserting all types of spring bars. Comes with two tips. One forked and the other pointed.



ITEM #	DESCRIPTION
58-1057	SPRING BAR REMOVER
58-1058	FORKED - POINTED TIP
58-1059	FORKED - LARGE TIP

15. Screw Type Link Pin Remover

An essential tool for removal of pins from metal bands. Adjustable for different band widths and has a guided plunger for accurate extraction.



ITEM #	DESCRIPTION
58-1065	BRACELET PIN REMOVER
58-1067	REPLACEMENT PIN

16. Bracelet Pin Plier- Value

Remove and insert pins easily with this well crafted tool. Extended support prevents damage to the band during operation. Includes two pin removal plungers.



ITEM #	DESCRIPTION
58-1077	BRACELET PIN PLIER
58-1078	SPARE PIN 0.60MM
58-1079	SPARE PIN 0.80MM



58-1211



58-1212



58-1216

Watch Winders Box & Cylinder Types

58-1211 / 58-1212: Elegant watch winders in silver and black. Automatically winds watches every day. Powered by one LR1.4 battery (included).

58-1216: Select from three different programmes-clockwise, alternating or anti-clockwise. The winder starts automatically everyday. Rotates at 4.5 turns a minute. Runs on three batteries "C" or AC power source.



17. Multi Purpose Pin Press

Indispensable tool for removal and replacement of friction pins, bracelet screws and Gucci-type bracelet screws. Solid steel body. Non-mar bracelet holder.

Accurately aligned punch pin.
Six pins 0.4, 0.6, 0.8, 1.0, 1.5, & 2.0mm.
Screwdriver 2.50mm.

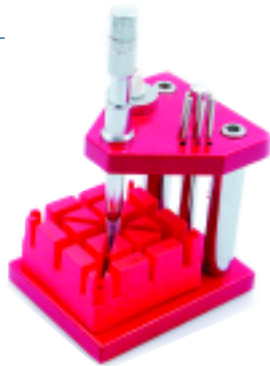

ITEM #	DESCRIPTION
58-1081	MULTI PURPOSE PRESS
58-1082	REPLACEMENT BRACELET HOLDER

18. Case Wrench-Jaxa Type

A well finished wrench with a comfortable grip. Comes complete with a full set of pins to fit all watch case backs.

Wrench and spare pins are neatly organized in a hardwood box.



ITEM #	DESCRIPTION
58-1084	CASE WRENCH- COMPLETE
58-1085	CASE WRENCH WITHOUT BOX
58-1086	CASE WRENCH BOX ONLY

19. L-G Master Case Opener

Comfortable knurled handle with fine adjustment for accurate setting.

Open or close all sizes and shapes of waterproof watches. Includes four sets of inserts for notches, holes, pins or polygons.



ITEM #	DESCRIPTION
58-1087	MASTER CASE OPENER

20. Case Wrench- Rolex Type

Opens all types of watch cases including Rolex Oyster.

Set includes handle with six milled chucks.

Sizes 18.5, 20.2, 22.5, 26.5, 28.3 and 29.5mm.



ITEM #	DESCRIPTION
58-1089	CASE WRENCH WITH CHUCKS

21. MKS Rolex Case Opener- Japan

Precision case opener for Rolex Oyster. Five tempered rings dia. 20.2, 22.5, 26.5, 28.3, and 29.5mm to fit Oyster case backs. Includes adapter with torque bar to open stubborn case backs.

Comes organized in a polished wooden box.

Dimensions: 230 x 85 x 45mm



ITEM #	DESCRIPTION
58-1090	MKS ROLEX CASE OPENER-47200

22. MKS Case Opener V-type- Japan

Ingenious tool that enables opening and closing all sizes of screw backs. Extended handles for a firm grasp. Claws adjust and lock in position for different sizes of case backs.



ITEM #	DESCRIPTION
58-1091	CASE OPENER V-TYPE -JAPAN

23. Bracelet Shear

Sturdy cast body with tempered steel rotary shear. Accurate positioning for a 90 degree cut. Designed to cut metal or mesh watch bands with ease. Unit can be clamped to the workbench for stability.

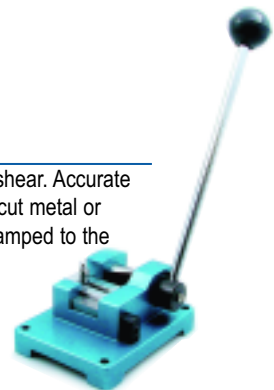

ITEM #	DESCRIPTION
58-1094	WATCH BRACELET SHEAR

24. Case / Movement Holder with Adjustable Posts

Well made holder for all sizes of screw back watch cases. Hard plastic posts are adjustable and contoured to hold the watch securely without damaging the surface.



ITEM #	DESCRIPTION
58-1098	MOVEMENT HOLDER



WATCH TOOLS & SUPPLIES

25. Micro-Shock Case Opener-6929

Use to open cases with pressure backs. Introduce the blade between the lip and the bezel, then move with a downward motion. Turn red screw head clockwise to increase and anti-clockwise to decrease micro shock.



BERGEON



ITEM #	DESCRIPTION
58-1018	MICRO-SHOCK OPENER

28. MKS Watch Case Opener

Watch case openers in two sizes with ergonomic handles.



ITEM #	DESCRIPTION
58-1101	CASE OPENER -9MM
58-1102	CASE OPENER -4MM

26. Case Knife Opener- German

A handy adjustable case opener. Comfortable PVC hand grip. Single edge tempered steel blade.



ITEM #	DESCRIPTION
58-1108	CASE KNIFE OPENER

29. MKS Pocket Size Case Opener

Pocket type case openers.



ITEM #	DESCRIPTION
58-1103	CASE OPENER -19MM
58-1104	CASE OPENER -9MM

27. Case Opener - Crab Type

A compact opener with a knurled screw to adjust the pins to fit different watch case backs. Pins are tempered and fine finished.

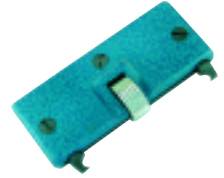

ITEM #	DESCRIPTION
58-1106	CASE OPENER

30. Case Closing Plier- France

Plier style tool with three dies. Parallel action jaws with rubber padded hinged discs for alignment.



ITEM #	DESCRIPTION
58-1112	CASE CLOSING PLIER

31. Case Press -Nylon Dies

A lightweight, inexpensive case press for snap back watch cases. Watch cases are set face down in mar resistant nylon dies. Comes with an assortment of 12 nylon dies.



ITEM #	DESCRIPTION
58-1113	CASE PRESS WITH NYLON DIES

32. Case Press -Aluminum Dies

Securely installs snap back watch cases. Plier grip extension for pressure control. Spring return. Comes with a set of hollow and flat dies.

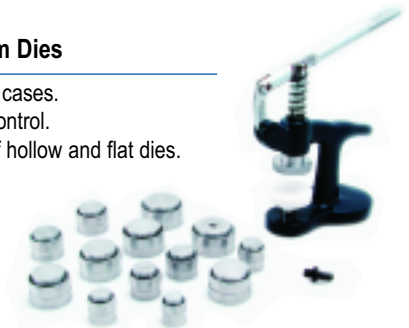

ITEM #	DESCRIPTION
58-1116	CASE PRESS WITH ALUMINUM DIES

33. Lever Type Case Press- France

Well engineered lever operated hand press to close watches with snap backs. Comes with five nylon dies and two additional spindles.



ITEM #	DESCRIPTION
58-1114	LEVER TYPE CASE PRESS

34. L-G "OpenAll" Case Wrench

This sturdy cast frame press clamp fits in your bench vise. Precision screw for fine control. Designed to open Rolex Oyster cases. Set of six rings. Sizes 18.5, 20.2, 22.5, 26.5, 28.3, and 29.5mm. Spare inserts available on order.

Replacement rings are available.



ITEM #	DESCRIPTION
58-1117	OPENALL CASE WRENCH -COMPLETE
58-1118	OPENALL CASE WRENCH
58-1119	OPENALL BASE ONLY



35. Watch Hand Remover- Presto

For easy removal of delicate watch or instrument hands. The center post acts as a support for removing the hands without touching the dial.



ITEM #	DESCRIPTION
58-1131	HAND REMOVER-PRESTO

36. Vise for Waterproof Watches

An ingenious hand held vise with an instant locking system. Plastic surface to protect cases. Adjustable 48 to 75 mm. Wt.: 0.65kg.



ITEM #	DESCRIPTION
58-1133	WATCH VISE

37. Crystal Remover

Replace watch crystals without dismantling the watch. Single knob opens and closes the claws which grip the crystal. Supplied complete with baseplate. For crystals 15-45mm.



ITEM #	DESCRIPTION
58-1136	CRYSTAL REMOVER

38. Case Holder

Clamps to your work bench. Specially shaped non-mar sliding jaws to hold all watch sizes.



ITEM #	DESCRIPTION
58-1141	BENCH TYPE HOLDER

39. Watch Hand Remover- Plunger

Simply push down on plunger to extract hands. The center post is a guide for removing the hands.



ITEM #	DESCRIPTION
58-1132	HAND REMOVER-PLUNGER

40. Watch Maker Hammers

Swiss style hammers, with finely polished forged steel heads fitted with hardwood handle.



ITEM #	DESCRIPTION
38-1341	HAMMER 50MM
38-1342	HAMMER 60MM

41. Spring Bars - Assorted Sets

Stainless steel straight double flange spring bars in a clear compartment box. Increments in one mm.

- 58-1191: 17 sizes-assorted 25 ea (8-24mm) thick
- 58-1192: 20 sizes-assorted 25 ea (5-22mm) medium
- 58-1193: 20 sizes-assorted 25 ea (5-22mm) thin



ITEM #	DESCRIPTION
58-1191	425 PCS S/BAR -1.8 MM
58-1192	500 PCS S/BAR- 1.5 MM
58-1193	500 PCS S/BAR- 1.3 MM

42. Case Press

Mini bench press that may be held in a vise. Includes a set of interchangeable non mar nylon dies.



ITEM #	DESCRIPTION
58-1144	HAND PRESS /DIES

43. Screwdriver Set -Value

Precision chrome plated screwdrivers with Elastomer heads for comfort.

Tempered steel blades. Set consists of 0.50, 0.60, 0.80, 1.00, 1.20, 1.40, 1.60, 2.0, 2.5, 3mm. Includes replaceable blades.



ITEM #	DESCRIPTION
48-1088	SET 10 PCS-STAND

For more screwdrivers see pg #258

44. Screwdriver Sets- France

Premium quality precision chrome plated screwdrivers with replacement blades. Anodized brass head freely rotates on ball bearings. Color coded to indicate size.



ITEM #	DESCRIPTION
48-1071	SET 9 PCS- IN BOX
48-1072	SET 9 PCS- STAND

45. Screwdriver Sets

Fixed blades are made in quality tool steel heat treated and tempered. Color coded for identification. Sizes #0.8-2.00



ITEM #	DESCRIPTION
48-1085	SET OF 6 PCS



WATCH TOOLS & SUPPLIES

46. B & L® Eye Loupes

Optical precision ground lightweight lens for a clear field of view. Magnifier has a lens diameter of 1".



39-2068

ITEM #	POWER	FOCAL
39-2061	4X	2½"
39-2062	5X	2"
39-2063	7X	1½"
39-2064	10X	1"
39-2068	4X & 7X	1½" X 2½"

47. Economy Eye Loupes

An economical lightweight loupe with ground and polished lens set in a black plastic holder. Provides distortion free viewing. Available in different focal lengths.



ITEM #	POWER	FOCAL
39-2051	10X	1"
39-2052	7X	1½"
39-2053	5X	2"
39-2054	4X	2½"
39-2055	3.3X	3"
39-2056	3X	3½"
39-2057	2.5X	4"
39-2058	2X	5"

48. Polywatch Scratch Remover

Polish paste for removing scratches on plastic watch crystal. Restores shine in minutes. Use Polywatch paste with a soft cloth. Sold bx/24



ITEM #	DESCRIPTION
58-1221	SCRATCH REMOVER-5G

49. MKS Dust Blower -Japan

Compact high quality PVC nozzle dust blower. Also available with integral dusting brush.



ITEM #	DESCRIPTION
58-1151	DUST BLOWER
58-1152	DUST BLOWER-BRUSH

50. Western Klear -Buffing Compound

Removes scratches and blemishes from watch crystals. A buffing wheel is charged with compound and the crystal is gently buffed.



ITEM #	DESCRIPTION
58-1181	CRYSTAL KLEAR -5 OZ.

51. Western Silcon-7® Sealant

A high vacuum pressure waterproof watch case sealant. Will not evaporate, vaporize, harden or breakdown. Unaffected by salts, acids or sweat.

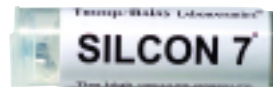

ITEM #	DESCRIPTION
58-1182	STEM SETTING LUBE

52. Western - "One-Dip"

An effective degreaser for watch parts. Protects as it cleans. Gentle and thorough cleaning action. Use as a dip or spray.



ITEM #	DESCRIPTION
58-1183	ONE DIP 8 OZ.

53. Crystal Cement

A crystal clear adhesive for setting watch crystals. Fine tip control for accurate application.



ITEM #	DESCRIPTION
49-1227	CRYSTAL CEMENT

54. Quartz Movement Cleaner

High purity solvent for cleaning metal and plastic quartz movements. Dries rapidly and leaves no residue. Quickly flushes away grease, oil or dirt. Contents 13 oz.



ITEM #	DESCRIPTION
58-1186	MOVEMENT CLEANER

55. Watch Tissue Paper

Lint-free, anti-tarnish tissue squares for wrapping or cleaning watch parts. Size 4" x 4" Box-1000 sheets.



ITEM #	DESCRIPTION
58-1188	WATCH TISSUE

56. Watch Cleaning Machine

An efficient and economic machine for cleaning watches. Powered by a self lubricating motor with a five speed regulator. Stainless steel basket with a compartment for four watches. Built-in 100w heater to speed the drying process.

Size: 12½" base X 20" ht. Wt. 19.5 lbs.



ITEM #	DESCRIPTION
58-1201	CLEANING MACHINE



Elma 57. Elma Watch Cleaning Machine- Germany

Super elite watch parts cleaning machine. Loading of the three chambers is done manually. One chamber is dedicated to spotless drying of the cleaned parts.

Dimensions 330 dia.x 500mm ht.
Wt. 19.5 lbs.



ITEM #	DESCRIPTION
58-1170	WATCH CLEANING MACHINE-110V
58-1171	WATCH CLEANING MACHINE-220V

Elma 58. Elma Watch Servicing Unit-Antimag

Electronic de-magnetizing unit. Large support base for watches and fine mechanical parts. Easy one button operation.
Dimensions: 160 x 130 x 60mm.
Wt: 2.2 lbs



ITEM #	DESCRIPTION
58-1175	ELMA WATCH SERVICE UNIT

Elma 59. Elma Watch Winder

May be used on a table top or wall mounted. This "artificial wrist"

controls and winds automatic watches. When clamped on the unit, the watch is put into every conceivable position of the wrist.

Dimensions: 380 x 155 x 450mm.



ITEM #	DESCRIPTION
58-1177	ELMA CYCLOMAT- SIX- WITHOUT STAND
58-1178	ELMA CYCLOMAT- TWELVE- WITH STAND
58-1179	ELMA CYCLOMAT- STAND

For export only

60. MKS Battery Change Tool Kit- Japan

Top of the line battery change kit. Set includes case vise, case opener, stainless steel AA tweezers, screwdriver and loupe.



ITEM #	DESCRIPTION
58-1161	BATTERY CHANGE KIT

Elma 61. Elma Leak Controller 2000

Check your watch for leaks after a battery change. By an integrated vacuum pump the device creates a pressure difference between the interior and the exterior of the watch. The test records any changes with a precision of 1/1000mm. If the differential pressure is steady the watch is watertight.



ITEM #	DESCRIPTION
58-1180	LEAK CONTROLLER

Elma 62. Elma Watch Winder- Motion Pure

Hand crafted, exquisite watch winder for two watches. Specifically designed for watches with lunar phases and eternal calendar.



ITEM #	DESCRIPTION
58-1164	WATCH WINDER -PEAR WOOD/ PEAR WOOD
58-1165	WATCH WINDER -PEAR WOOD/ LACQUER
58-1166	WATCH WINDER -PEAR WOOD/ LEATHER

Elma 63. Elma Watch Winder - Motion Corona

The Elma Corona series (includes batteries). Features an adjustable sleep mode and direction of winding. Power adapter (optional).

Dimensions: 250 x 210 x 190mm



ITEM #	DESCRIPTION
58-1167	CORONA 2 BURLWOOD
58-1168	CORONA 2 BURLWOOD/ GLASS DOORS
58-1169	CORONA 2 PIANO/BLACK

64. MKS Special Watch Vise- Japan

Well finished watch vise made in delrin for long lasting service. Will not mar the surface of watch. Includes screws to attach vise to the work bench.

Dimensions: 100 x 100 x 30mm.
Wt: 0.25 kg.

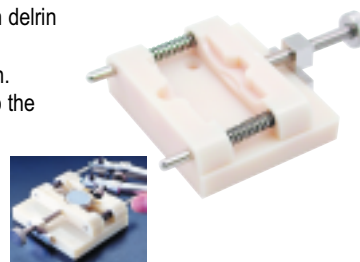

ITEM #	DESCRIPTION
58-1162	WATCH VISE



WATCH TOOLS & SUPPLIES

Energizer 65. Watch Battery Kits

Energizer Watch Battery kits are the ideal way to start your replacement sales. Two assortment kits contain the most popular batteries together with a set of assorted tools.

Basic Starter Kit:

60 Drawer Cabinet, Battery Tester, Cross Reference Guide, Battery Size Checker, Store Counter Sign, Training Booklet

Battery Types (130 Total):

20 Each: 377SP, 364SP 5 Each: 379, 371, 376, 395, 357, 321, 317, 370, 319, 392, 362, 397, 399, 337, 373, ECR2016, ECR1216, ECR2032



ITEM #	DESCRIPTION
58-1502	BASIC STARTER KIT
58-1507	W/BATTERY CABINET

Deluxe Kit :

60 Drawer Cabinet, Watch Battery Analyzer, Cross Reference Guide, Battery Size Checker, Store Counter Sign, Training Booklet and Video, Watch Tool Kit

Battery Types (200 Total):

20 Each: 377SP, 362SP, 379SP
5 Each: 371, 376, 370, 392, 397, 337, 394, 315, 303, 384, 391, 395, 357, 321, 317, 319, 362, 399, 373, 396, 389, 344, 390, ECR1216, ECR2025, ECR2016, ECR2032, ECR1025



ITEM #	DESCRIPTION
58-1504	DELUXE KIT

66. Watch Battery Analyzer

Easy to use tester, designed to check a watch or if the battery needs replacement without opening the watch. Sleek design with complete instructions.

ITEM #	DESCRIPTION
58-1510	BATTERY ANALYZER



70. Watch Repair Tool Kit

Contains all the tools needed to change batteries. Items are neatly organized in a leather pouch.

Set Contains:

- Telescopic loupe 10x
- Case opener for pressed in cases
- Case opener for screw type cases
- Plastic tweezer for batteries
- Screwdrivers 1.00 & 1.60mm
- Deluxe spring bar tool



ITEM #	DESCRIPTION
58-1523	WATCH REPAIR TOOL KIT

71. Watchmaker Service Set-Mini

Well organized plastic box contains all the tools needed to service watches.

Set Contains:

- Key for opening waterproof cases
- Case opener and knife (Victorinox)
- Plastic tweezer for batteries
- Screwdrivers 1.00 & 1.60mm
- Spring bar tool



ITEM #	DESCRIPTION
58-1521	WATCHMAKER SERVICE SET-MINI

67. Battery Reference Guide

A complete cross reference to identify the most used batteries in watches, electronic and medical devices.

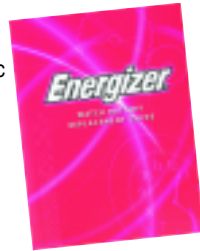

ITEM #	DESCRIPTION
58-1506	REFERENCE GUIDE

68. Battery Size Checker

Use this handy template to check the battery size. The size is indicated by the slot which fits the diameter of the battery.



ITEM #	DESCRIPTION
58-1508	SIZE CHECKER

69. Watch Battery Tester

Tests the full range of silver oxide, mercury, lithium and electronic batteries. Instructions included.



ITEM #	DESCRIPTION
58-1512	BATTERY TESTER



Energizer

- A complete line of premium watch batteries to provide dependable, long lasting power
 - Cutting edge technology delivers world class capacity, shelf life and leakage resist.
- Engineered for an unbeatable performance

72. Silver Oxide Watch Batteries

- Silver Oxide 1.55 Volts
- Convenient packs in tear strips of five cells
- Sold per cell

Available in
space pack

ITEM #	TYPE
58-1357	#364/363*
58-1362	#377/376*
58-1363	#379

ITEM #	TYPE	ITEM #	TYPE
58-1309	#309	58-1344	#344
58-1315	#315	58-1346	#346
58-1317	#317	58-1365	#365
58-1319	#319	58-1366	#366
58-1321	#321	58-1373	#373
58-1329	#329	58-1379	#379
58-1335	#335	58-1381	#381
58-1337	#337	58-1387	#387
58-1339	#339	58-1391	#391
58-1341	#341	58-1393	#393

ITEM #	MULTI DRAIN
58-1357	#357/303*
58-1362	#362/361*
58-1364	#364/363*
58-1371	#371/370*
58-1377	#377/376*
58-1386	#386/301*

ITEM #	MULTI DRAIN
58-1390	#390/389*
58-1392	#392/384*
58-1394	#394/380*
58-1395	#395/399*
58-1397	#397/396*

* **Multi Drain** Increased shelf life up to seven years!!! With the new Energizer Multi Drain watch battery you will be able to replace any silver oxide battery. Multi Drain batteries utilize an innovative cell chemistry to bring you the best characteristics of both high drain and low drain systems in one battery type. Multi Drain batteries will work in any watch (high drain or low drain.)



Energizer

73. Lithium Batteries

- Lithium batteries are perfect for high tech devices
- Convenient packs in tear strips of five batteries
- Lithium Oxide 3.0 Volts



ITEM #	TYPE	ITEM #	TYPE
58-1401	ECR1025	58-1408	ECR2012
58-1402	ECR1216	58-1409	ECR2016
58-1403	ECR1220	58-1410	ECR2025
58-1404	ECR1225	58-1412	ECR2032
58-1405	ECR1616	58-1413	ECR2320
58-1406	ECR1620	58-1414	ECR2430
58-1407	ECR1632	58-1415	ECR2450

74. Battery Tool Kits

- Well organized compact pouch contains all the tools needed to change a battery
- The deluxe kit contains a spring bar tool and a watch case holder



ITEM #	DESCRIPTION
58-1514	BATTERY BASIC TOOL KIT
58-1515	BATTERY DELUXE TOOL KIT

Keep Going

We proudly stock **Energizer**,
the only watch battery manufactured in the USA.





WAXES

- Alcohol Lamps 342
- Bouron® Wax Tools 343
- Castaldo Injection Waxes 331
- Debubbler 333
- Deluxe Wax Mandrel Set 342
- Designer Templates-Japan 344
- Disclosing Wax 333
- Double-End Vulcanite Files 344
- Ferris Cowdery Profiles 331
- Ferris File-A-Wax® Shapes 328
- Ferris File-A-Wax® Sets 327
- Ferris File-A-Wax® ASL / BSL 327
- Ferris Flexible Wax Sheets 330
- Ferris Injection Waxes 330
- Ferris Inlay Wax 330
- Ferris Mold-A-Wax® 333
- Ferris Red Utility Wax Sheets 332
- Ferris Sprue Wax Rods 326
- Ferris Wax Ring Tubes 330
- Ferris Yellow Sticky Wax 332
- Kerr Injection Waxes 341
- Kerr Mastertouch™ 342
- Kerr Smoothy Flamless Finisher 341
- Kerr Ultra Waxer 344
- Mandrel Tapered / Stepped 339
- Matt® Bracelet Template 339
- Matt® Creative Setting Kit 338
- Matt® Gold Collector 337
- Matt® Mini Lathe with Gauge 336
- Matt® Miter Box Set 338
- Matt® Reamer 339
- Matt® Ring Template 339

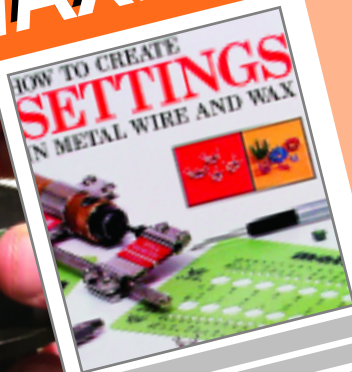

- Matt® Ring Tube Sizer 336
- Matt® Shaper 337
- Matt® Techniques of Design 339
- Matt® Trimmer 337
- Matt® Wax Bars & Slices 335
- Matt® Wax Gun Kit 338
- Matt® Wax Pellets for Matt Gun 338
- Matt® Wax Ring Tubes 334
- Matt® Wax Rods 338
- Matt® Wax Routing Bur 336
- Matt® Wax Tablets 336
- Micro Film 333
- Plasti-O-Wax 332
- Precision Waxer 343
- Solitone 333
- Speedy Wax Pen 342
- Vacuifilm 333
- Wax Carver's Tools Set 342

- Wax Detailer 344
- Wax Kleen 336
- Wax Heating Tray 343
- Wax-A-Sizer 344
- Wax Rasps 344
- Wax Wire Spool 333
- Wax Worker 343
- Wolf Build Up / Repair Wax 329
- Wolf Gold/Silver C/Wax Tubes 329
- Wolf Positioning Wax 329
- Wolf Relief Wax 329
- Wolf Touch-Up Wax 329
- Wolf's Precision Wax Carvers 340

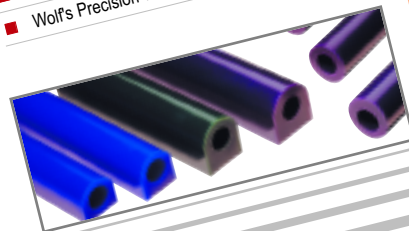

Jewelry Wax Modeling

by Adolfo Mattiello

Learn how to effectively use carving wax to express your ideas and create harmonious designs. Jewelry modeling techniques are presented with progressive step-by-step instructions and drawings of each model. Contains practical information on tools and stone setting, as well as creating your own templates. Provides answers to frequently asked questions.

61-1051 (Hardcover – 161 pages)





1. File-A-Wax® Wax Ring Tubes

The preferred wax for jewelry casters because clean burn out from molds is guaranteed. Convenient easy to use shapes to make models reproduced by the lost wax process. Ideal for creating designs as it can be routed, sawn or shaped by hand or machine. Available in three hardness grades. Can not be injected or steam dewaxed. Bars are 6" long.

Sold each

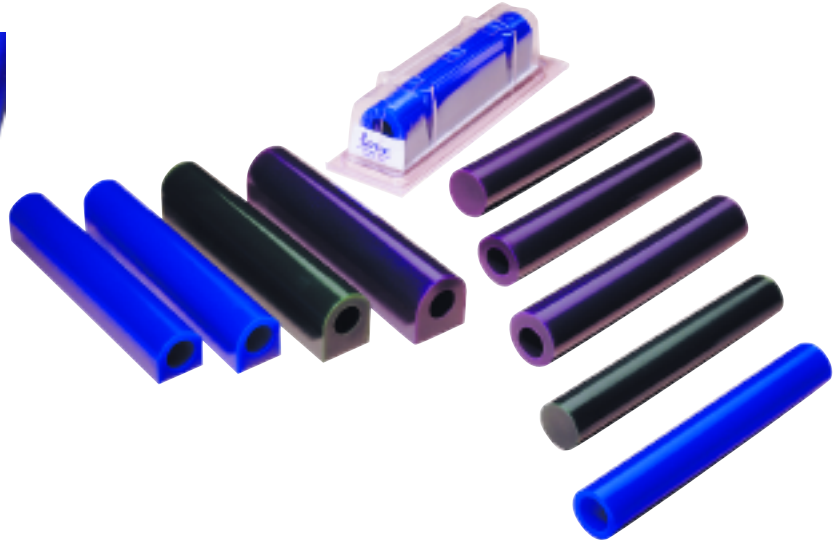
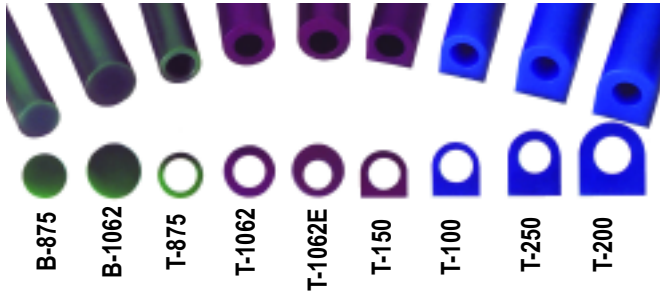

COLOR	CHARACTERISTICS	TEMP
■ BLUE	Flexible with regular hardness	240°F
■ PURPLE	Medium hard, with limited flexibility	240°F
■ GREEN	Hard, with no flexibility	240°F

ECC: Eccentric Center



FLAT SIDED TUBES (T100)

1 1/8" X 1" 5/8" Ø HOLE/ECC

ITEM #	COLOR
59-1011	■ BLUE
59-1012	■ PURPLE
59-1013	■ GREEN

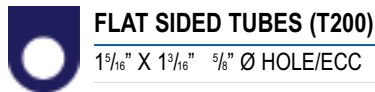

FLAT SIDED TUBES (T200)

1 5/16" X 1 3/16" 5/8" Ø HOLE/ECC

ITEM #	COLOR
59-1014	■ BLUE
59-1015	■ PURPLE
59-1016	■ GREEN



FLAT SIDED TUBES (T250)

1 1/8" X 1 1/8" 5/8" Ø HOLE/ECC

ITEM #	COLOR
59-1017	■ BLUE
59-1018	■ PURPLE
59-1019	■ GREEN



FLAT SIDED TUBES (T150)

1 X 1" 5/8" Ø HOLE

ITEM #	COLOR
59-1021	■ BLUE
59-1022	■ PURPLE
59-1023	■ GREEN

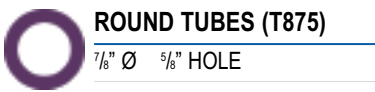

ROUND TUBES (T875)

7/8" Ø 5/8" HOLE

ITEM #	COLOR
59-1024	■ BLUE
59-1025	■ PURPLE
59-1026	■ GREEN

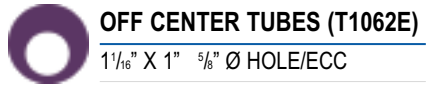

OFF CENTER TUBES (T1062E)

1 1/8" X 1" 5/8" Ø HOLE/ECC

ITEM #	COLOR
59-1027	■ BLUE
59-1028	■ PURPLE
59-1029	■ GREEN

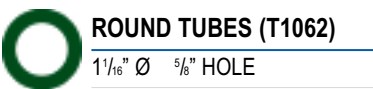

ROUND TUBES (T1062)

1 1/16" Ø 5/8" HOLE

ITEM #	COLOR
59-1031	■ BLUE
59-1032	■ PURPLE
59-1033	■ GREEN

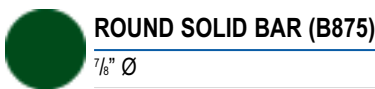

ROUND SOLID BAR (B875)

7/8" Ø

ITEM #	COLOR
59-1034	■ BLUE
59-1035	■ PURPLE
59-1036	■ GREEN



ROUND S/ BAR (B1062)

1 1/16" Ø

ITEM #	COLOR
59-1037	■ BLUE
59-1038	■ PURPLE
59-1039	■ GREEN



File-A-Wax® Kits

These File-A-Wax kits are convenient and ready to use for a multitude of jewelry pieces and designs. All three hardness grades can be shaped, filed or carved. Experienced jewelers worldwide prefer to keep a selection of different shapes on hand. This affords them the ability to respond quickly to design assignments or use for their own creative inspirations.

2. File-A-Wax® Slice Assortment- ASL

Includes pieces 1⁷/₁₆" X 3⁵/₈" sliced in thicknesses from 1¹/₈" to 1¹/₄" thick. Available in 1/2 lb.

Assortment Contains:

Six pieces, 0.280" thick

Six pieces, 0.200" thick

Six pieces, 0.135" thick

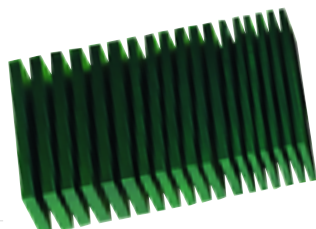

ITEM #	COLOR	WT
59-1041	■ BLUE	1/2 LB
59-1042	■ PURPLE	1/2 LB
59-1043	■ GREEN	1/2 LB

3. File-A-Wax® Slice Assortment- BSL

Includes pieces 1⁷/₁₆" X 3⁵/₈" sliced in thicknesses from 3¹/₈" to 1" thick. Available in 1lb.

Assortment Contains:

One piece, 1.00" thick

Three pieces, 0.700" thick

Four pieces, 0.280" thick

Four pieces, 0.190" thick

Four pieces, 0.140" thick

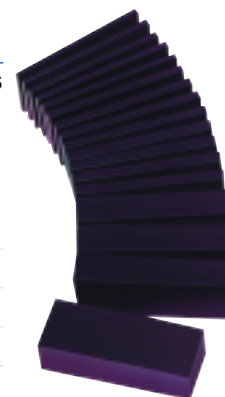

ITEM #	COLOR	WT
59-1046	■ BLUE	1 LB
59-1047	■ PURPLE	1 LB
59-1048	■ GREEN	1 LB

4. File-A-Wax® Blocks

Jewelry craftsmen find them invaluable for free form designing and all types of modelling. Conveniently available in blue, purple and green.

1/2 lb : 3¹/₂" X 3¹/₂" X 1¹/₈" thick block

1 lb : 3⁵/₈" X 6" X 1¹/₂" thick block



COLOR	1/2 LB	\$/ EA	1 LB
■ BLUE	59-1051	7.00	59-1054
■ PURPLE	59-1052	7.00	59-1055
■ GREEN	59-1053	7.00	59-1056

5. File-A-Wax® Bars

Perfect for free form design work. Conveniently available in blue, purple and green.

Bar size 1³/₁₆" sq. X 3³/₄" long

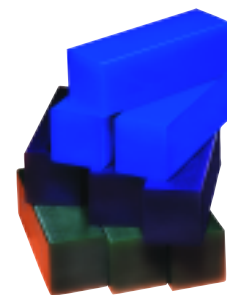

ITEM #	COLOR	1 LB
59-1057	■ BLUE	3 BARS
59-1058	■ PURPLE	3 BARS
59-1059	■ GREEN	3 BARS

6. File-A-Wax® Basic Kit

Convenient and ready to use for all your design needs. The kit contains one bar each of blue, purple, green.

Size 1³/₁₆" sq. X 3¹/₂" long

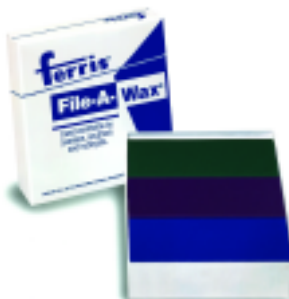

ITEM #	DESCRIPTION
59-1061	BLUE/PURPLE/GREEN 1 EA

7. File-A-Wax® Assortment Sets

The junior kit features a special assortment of 11 pieces in a variety of shapes and sizes. The professional kit contains 14 pieces. Both kits have a combination of all three hardness grades.

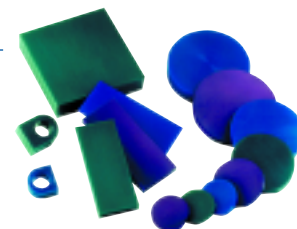

ITEM #	DESCRIPTION	CONTENTS
59-1064	PROFESSIONAL	14 PCS
59-1065	JUNIOR	11 PCS



8. File-A-Wax® Designer Shapes

Designer shapes provide a selection of basic pieces that reduce both carving time and waste. Perfect for large custom and design work. May be worked both by hand or machine.

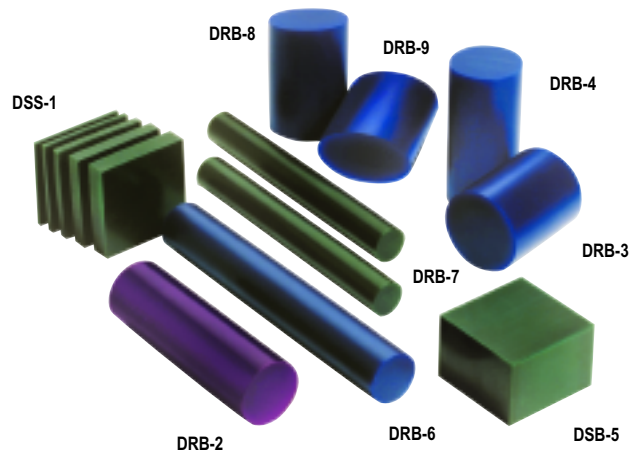

COLOR	CHARACTERISTICS	TEMP
■ BLUE	Flexible with regular hardness	240°F
■ PURPLE	Medium hard, with limited flexibility	240°F
■ GREEN	Hard, with no flexibility	240°F

ECC: Eccentric Center

ROUND DRB-7
 $1\frac{5}{16}" \text{ } \varnothing \times 11\frac{1}{4}" \text{ LONG} - 2 \text{ PCS}$

ROUND DRB-6
 $1\frac{3}{4}" \text{ } \varnothing \times 12\frac{1}{8}" \text{ LONG} - 1 \text{ PC}$

ROUND DRB-2
 $2\frac{1}{4}" \text{ } \varnothing \times 7\frac{1}{2}" \text{ LONG} - 1 \text{ PC}$

ITEM #	COLOR
59-1071	■ BLUE
59-1072	■ PURPLE
59-1073	■ GREEN

ITEM #	COLOR
59-1074	■ BLUE
59-1075	■ PURPLE
59-1076	■ GREEN

ITEM #	COLOR
59-1077	■ BLUE
59-1078	■ PURPLE
59-1079	■ GREEN

ROUND DRB-4
 $2\frac{5}{8}" \text{ } \varnothing \times 5\frac{1}{2}" \text{ LONG} - 1 \text{ PC}$

ROUND DRB-3
 $3\frac{1}{16}" \text{ } \varnothing \times 4\frac{1}{16}" \text{ LONG} - 1 \text{ PC}$

OVAL DRB-8
 $3\frac{1}{4}" \times 2\frac{1}{4}" \times 4\frac{5}{8}" \text{ HT.} - 1 \text{ PC}$

ITEM #	COLOR
59-1081	■ BLUE
59-1082	■ PURPLE
59-1083	■ GREEN

ITEM #	COLOR
59-1084	■ BLUE
59-1085	■ PURPLE
59-1086	■ GREEN

ITEM #	COLOR
59-1087	■ BLUE
59-1088	■ PURPLE
59-1089	■ GREEN

OVAL DRB-9
 $3\frac{5}{8}" \times 2\frac{3}{4}" \times 3\frac{5}{8}" \text{ HT.} - 1 \text{ PC}$

SQUARE DSB-5
 $3\frac{3}{16}" \times 2\frac{3}{8}" \text{ THICK} - 1 \text{ PC}$

SQUARE DSS-1 (5 PCS)
 $3\frac{3}{8}" \text{ SQ.} - \frac{7}{16}" , \frac{11}{16}" , \frac{3}{8}" \text{ \& } \frac{3}{16}" (2 \text{ PCS})$

ITEM #	COLOR
59-1091	■ BLUE
59-1092	■ PURPLE
59-1093	■ GREEN

ITEM #	COLOR
59-1094	■ BLUE
59-1095	■ PURPLE
59-1096	■ GREEN

ITEM #	COLOR
59-1097	■ BLUE
59-1098	■ PURPLE
59-1099	■ GREEN



9. Flexible Wax Sheets

High grade wax sheets are used for a variety of applications, drawings, layout and tracings. Sheets can be cut with scissors and formed into shapes as desired. Two grades Green- Firm. Pink- Soft
Sold 32 sheets/bx.

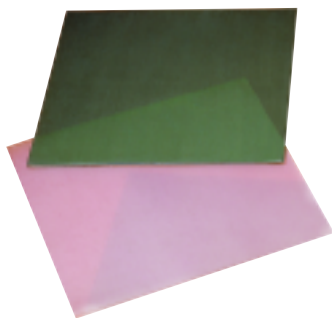

Gauge	inch/ mm	Green 4" X 4"	Pink 4" X 4"	Green 3" X 6"	Pink 3" X 6"
14	0.064" /1.6mm	59-1101	59-1111	59-1121	59-1131
16	0.051" / 1.3mm	59-1102	59-1112	59-1122	59-1132
18	0.040" / 1.0mm	59-1103	59-1113	59-1123	59-1133
20	0.032" / 0.8mm	59-1104	59-1114	59-1124	59-1134
22	0.025" / 0.6mm	59-1105	59-1115	59-1125	59-1135
24	0.020" / 0.5mm	59-1106	59-1116	59-1126	59-1136
26	0.015" / 0.4mm	59-1107	59-1117	59-1127	59-1137

Wax Sheets-Assortment

Size 4" sq x 32 sheets. 4 sheets 16G & 18G and 6 sheets of 20G, 22G, 24G, 26G each

ITEM #	COLOR
59-1141	PINK
59-1142	GREEN



Wolf's Precision Wax Carvers -Book

by **Kate Wolf**
 Discover the techniques of wax carving using the "wicked sharp" tools by Kate Wolf.



10. Wolf Gold & Silver Carving Wax Tubes & Bars

Gold and silver color carving waxes allow designers the ability to create a model in the same color the article will be when finished. Slightly flexible with medium hardness. Burns out cleanly from the mold. Melts at approx. 240°F (115°C).

Sold each.

ECC: Eccentric Center

SOLID ROUND (B1062)
1 1/16" X 6" LONG

ITEM #	COLOR
59-1441	GOLD
59-1442	SILVER

ROUND TUBE (T1062)
1 1/16" X 6" LONG

ITEM #	COLOR
59-1443	GOLD
59-1444	SILVER

OFF CENTER TUBES (T1062E)
1 1/16" X 6" LONG HOLE /ECC

ITEM #	COLOR
59-1445	GOLD
59-1446	SILVER

SOLID BLOCK DSB-5 1 LB
3 3/16" SQ X 2 3/8" THICK

ITEM #	COLOR
59-1451	GOLD
59-1452	SILVER

FLAT SIDED TUBES (T200)
1 3/16" X 1 5/16" X 6" LONG ECC HOLE

ITEM #	COLOR
59-1447	GOLD
59-1448	SILVER

SOLID ROUND DRB-7 - 1/2 LB
1 5/16" Ø X 1 1/4" LONG -2 PCS

ITEM #	COLOR
59-1453	GOLD
59-1454	SILVER

FLAT SIDED TUBES (T100)
1" X 1 1/8" X 6" LONG ECC HOLE

ITEM #	COLOR
59-1449	GOLD
59-1450	SILVER

SLICE SET DSS-3 1 LB
5 SQUARE SLICES 3 9/16" ASSORTED

ITEM #	COLOR
59-1455	GOLD
59-1456	SILVER

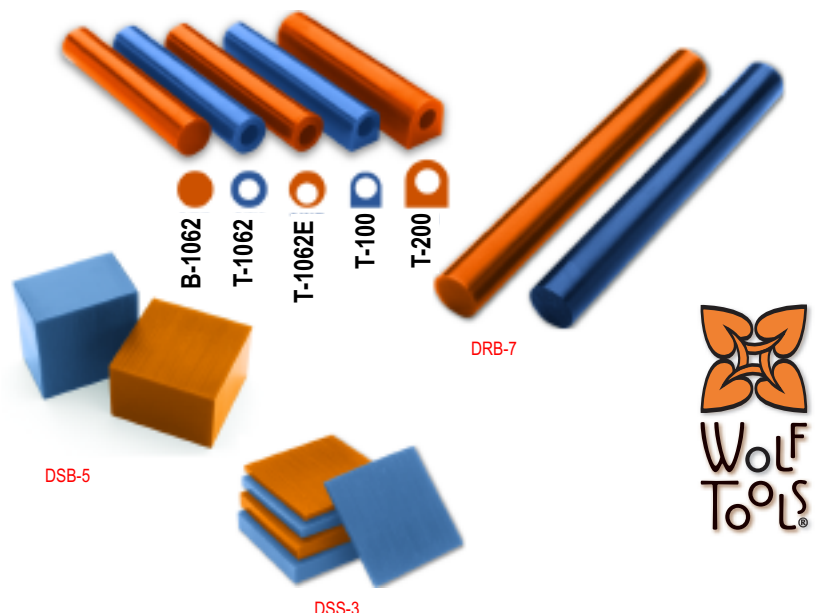

11. Positioning Wax

Ideal for securing stones for accurate tracing. 3 oz. (85g)
Melts at approx. 173°F (78°C).



ITEM #	SIZE
59-1461	3/16" SQ. X 5" L

12. Touch-Up Wax

Ideal for final touch-up of surface imperfections.
Melts at approx. 163°F (73°C).



ITEM #	WT.
59-1462	2 OZ.

13. Relief Wax

Use for creating raised detail on carving wax.
Melts at approx. 163°F (73°C).



ITEM #	WT.
59-1463	2 OZ. BURGUNDY

14. Build Up / Repair Wax

Easy for build up of repaired sections.
3 oz (85g)
SIZE : 1 1/16" SQ. X 3 5/16" LONG



ITEM #	COLOR
59-1464	GOLD
59-1465	SILVER



15. Injection Waxes

These fine injection waxes are suitable for special applications according to their properties. All wax types have built-in release agents that are helpful for easy extraction.



Turquoise

A general purpose, tough, medium hard wax suitable for thin or thick sections. Self releasing from the mold. Injection Temp. 155°/68°C.

59-1151 50 LBS

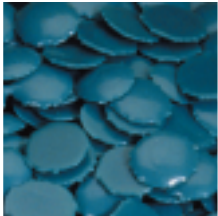

Blue

A tough, hard wax that is ideally suited for molds with difficult draws. Easy clean extraction for intricate patterns. Injection Temp. 155°/68°C.

59-1152 50 LBS



Aqua

An all purpose medium hard tough wax that is well suited for small to large molds. Inherent properties are good for fine details. Injection Temp. 160°/71°C.

59-1153 50 LBS



Red

A special feature of this medium hard wax is its fluidity that contributes towards excellent memory and readability. Injection Temp. 160°/71°C.

59-1154 50 LBS

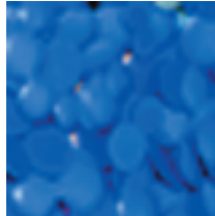

Magna-Blue

Similar characteristics as the turquoise, but the brighter hue allows for more clear definition. Tough with regular hardness. Injection Temp. 155°/68°C.

59-1155 50 LBS



Magna-Pink

A fast melting fluid specialty wax that combines hardness and toughness. Minimal shrinkage reproduces fine detail work. Injection Temp. 155°/68°C.

59-1156 50 LBS



Platinum- Lavendra

A low temperature injection wax of outstanding durability and strength. Good flow characteristics give crisp details. Formulated for extended shelf life. Minimal shrinkage with flexibility. Injection Temp. 160°/71°C.

59-1161 50 LBS

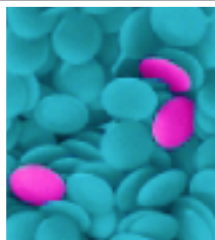

Magna Stone Set - *New*

A highly fluid wax useful to meet the demands of cast-in-place stone set manufacture. Can be injected at pressures as low as 2 lbs. Fills the most intricate details and virtually eliminates mold lines.

Injection Temp. 158°/70°C
59-1165 50 LBS



Platinum- Light Green

Good fluidity and excellent reproduction. Injection Temp. 155°/68°C.

59-1162 50 LBS



Practical Wax Modeling

Advanced Techniques for Wax Modelers

by Hiroshi Tsuyuki and Yoko Ohba

The companion text to "Basic Wax Modeling" with detailed instructions and photos of each technique.

61-1053 (Hardcover – 34 pages)

16. Mold-A-Wax®

Use for blending with other waxes. Black- Medium pliability; Red- Soft



ITEM #	DESCRIPTION
59-1171	BLACK 1 LB
59-1172	RED 1 LB

17. Inlay Wax

A wax for filling voids, building and repairing wax patterns. Can be carved without chipping or breaking. Melts at approx. 163°F (73°C).

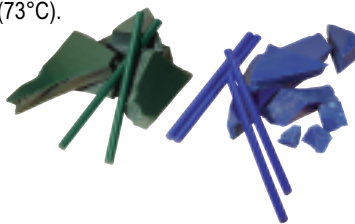

ITEM #	DESCRIPTION	COLOR
59-1174	STICK 1/4" Ø X 5" L 3 OZ	■ BLUE
59-1175	STICK 1/4" Ø X 5" L 3 OZ	■ GREEN
59-1178	CHUNK -BROKEN 1 LB	■ BLUE
59-1179	CHUNK -BROKEN 1 LB	■ GREEN

18. Yellow Sticky Wax

A fast sticky wax for joining different waxes together. Melts at approx. (250-275°F /122-135°C).



ITEM #	DESCRIPTION
59-1181	STICKY 1/4" Ø X 4"
59-1182	CHUNKS- 1 LB
59-1183	BEADS- 1 LB



19. Cowdery Profiles

Cowdery Profiles were developed to help jewelry designers reduce time and effort in creating prong settings, clasps, hinges or other complex shapes. Precision-formed extrusion can be used individually or in combinations. Select from 14 styles in 10 sizes. Available in blue (soft) and purple (hard). Sold in 5" length. Packaged in convenient plastic tubes (one size, style and color per tube).

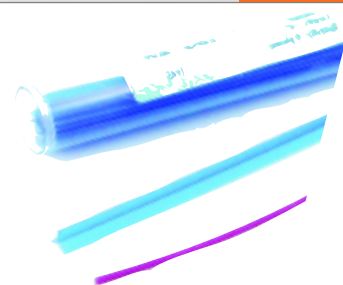

	Shapes														
	Style	Round Rod	Square Rod	Round Tube	Square Tube	Flat Ribbon	Hinge Tube 1.00mm	Channel	90° Corner	60° Corner	3-Prong	4-Prong	5-Prong	90° Corner	Ball & Socket
1.00MM	Blue	59-1201	59-1221					59-1321							
	Purple	59-1202	59-1222					59-1322							
1.50MM	Blue	59-1203	59-1223					59-1323	59-1333	59-1343					
	Purple	59-1204	59-1224					59-1324	59-1334	59-1344					
2.00MM	Blue	59-1205	59-1225	59-1245	59-1265	59-1285	59-1305	59-1325							
	Purple	59-1206	59-1226	59-1246	59-1266	59-1286	59-1306	59-1326							
2.50MM	Blue	59-1207	59-1227	59-1247	59-1267		59-1307	59-1327							
	Purple	59-1208	59-1228	59-1248	59-1268		59-1308	59-1328							
3.00MM	Blue	59-1209	59-1229	59-1249	59-1269	59-1289	59-1309							59-1411	
	Purple	59-1210	59-1230	59-1250	59-1270	59-1290	59-1310							59-1412	
3.50MM	Blue	59-1211	59-1231	59-1251	59-1271										59-1425
	Purple	59-1212	59-1232	59-1252	59-1272										59-1426
4.00MM	Blue	59-1213	59-1233	59-1253	59-1273	59-1293									
	Purple	59-1214	59-1234	59-1254	59-1274	59-1294									
5.00MM	Blue			59-1255	59-1275	59-1295									
	Purple			59-1256	59-1276	59-1296									
6.00MM	Blue			59-1257	59-1277										
	Purple			59-1258	59-1278										
8.00MM	Blue									59-1359	59-1369	59-1389			
	Purple									59-1360	59-1370	59-1390			



Supercera Injection Wax

Specially formulated waxes made from non-toxic natural ingredients. Positively clean burn out is assured without any ash residue. Built-in release agent allows easy extraction from the mold. Select from various types to suit your application. Sold in block form pk/-50lb.

ITEM #	COLOR	CHARACTERISTICS	TEMP.
59-1471	AQUA	VERY FLEXIBLE	140°F/60°C
59-1472	ORANGE	FLEXIBLE	155°F/68°C
59-1473	RED	GENERAL PURPOSE	165°F/74°C
59-1474	GOLD	HARD	170°F/76°C
59-1475	GREEN	MIN. SHRINKAGE	150°F/65°C

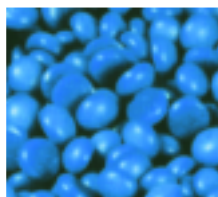

Blue Plastic Wax

Castaldo® Blue Plastic™ wax is made of a combination of high quality wax compounds and special plastics blended to offer all the best qualities of both materials.

59-1481 50 LBS



Golden River- Wax Additive

Golden River™ wax additive makes jewelry injection waxes flow like water. And there is no need to change waxes or clean out your wax pot with all the work, mess and delay that it causes.

59-1482 4.4 LB / 2 KG BAG

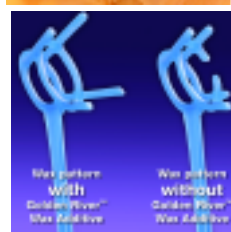



KerrLab 20. Precision Injection Waxes- AccuBeads™

Improved formula: High density micro-crystalline structure delivers precise, smooth, shiny patterns. **Multi Use:** Designed for platinum, gold, silver as well as other industrial alloys. **Quick melting:** Easy pouring micro-beads designed for fast melting. **Low ash content:** Cleanest burnout possible.

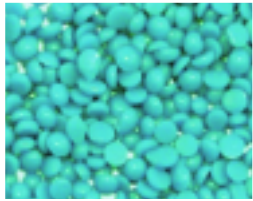

Aqua- Green

All purpose, best detail, highest flow and lowest shrinkage. Injection Temp. 150°F/65°C.

59-1497 33497 50 LBS

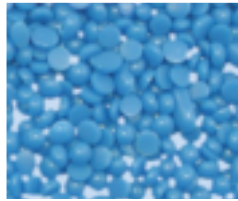

Flex Plast- Blue

Longest shelf life, highest flexibility, metal molds and stone in place. Injection Temp. 155°F/68°C.

59-1501 33501 50 LBS



Ruby Red

All purpose, best detail, highest flow and lowest shrinkage. Injection Temp. 150°F/65°C.

59-1498 33498 50 LBS

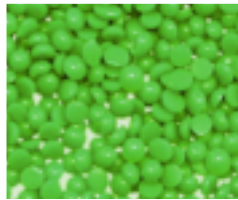

Tuffy Green

Large pieces, toughest, eliminates bowing on flat surfaces. Injection Temp. 165°F/73°C.

59-1502 33502 50 LBS

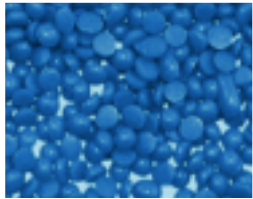

Turquoise Blue

All purpose, best detail, highest flow and lowest shrinkage. Injection Temp. 150°F/65°C.

59-1499 33499 50 LBS



Super Pink

Bezel settings, quickest solidification, will not give. Injection Temp. 150°F/65°C.

59-1503 33503 50 LBS

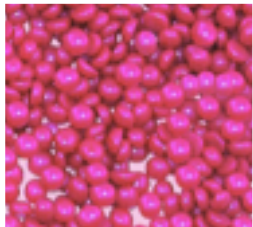

NYC-Pink

Highest detail, filigree, easy removal without breakage. Injection Temp. 155°F/68°C.

59-1500 33500 50 LBS



ACCU® Carve

Highly carvable, minimal gumming on files and tools. Injection Temp. 174°F/79°C.

59-1504 33504 50 LBS



Plast-O-Wax - Dark Blue

A frequently used plastic wax in darker shades for easy readability. Renders a good smooth surface with minimal shrinkage. Ideal for detail work.

59-1511 50 LBS



Plast-O-Wax - Purple

Higher Plasticity. Injection Temp. 160°F/71°C

59-1512 50 LBS

21. Sprue Wax Rods

These rods are refined to eliminate impurities and guaranteed to burn out quickly without expansion or residue. Perfect for use in a sprue building system. Available in different diameters and lengths to suit every demanding application.

Red - Flexible and in regular hardness.

Green - More pliable and medium hard.



ferris

ITEM #	DIA. X L	COLOR
59-1911	1/4" X 6"	GREEN
59-1912	3/8" X 6"	GREEN
59-1916	3/8" X 24"	GREEN

ITEM #	DIA. X L	COLOR
59-1921	1/4" X 6"	RED
59-1922	3/8" X 6"	RED
59-1926	3/8" X 24"	RED



22. Wax Wire Spool

Pliable wax wire in gauge sizes, strong enough to be twisted, bent or formed to any shape without cracking or breaking. Suitable for applications such as clasps, prongs, retention or sprues. Pkg ¼ lb.

GAUGE	INCH	MM	ROUND	HF. RND
6	0.162"	4.1	59-1551	
8	0.129"	3.3	59-1552	
10	0.102"	2.6	59-1553	59-1563
12	0.081"	2.1	59-1554	59-1564
14	0.064"	1.6	59-1555	59-1565
16	0.051"	1.3	59-1556	
18	0.040"	1.0	59-1557	
20	0.032"	0.8	59-1558	

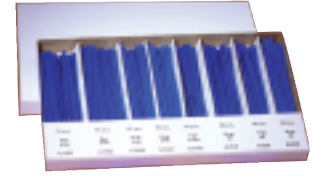

Wax Wire Assortment

Size 4" length. Round 10, 14 and 18G Half-Round: 6, 8, 12 and 14G Half-Pear: 6G

ITEM #	DESCRIPTION
59-1569	ASSORTED WAX WIRE



23. Debubblizer

A surface tension reducing agent that enables investment to flow uniformly and fill all portions of the wax pattern.



59-1571	8 OZ
59-1572	32 OZ



24. Micro Film

An oily, but water soluble die lubricant, that aids release of wax patterns from molds without distortion.



59-1573	8 OZ
59-1574	32 OZ



25. Vacufilm

Reduces surface tension specifically for investing under vacuum.



59-1575	8 OZ
59-1576	32 OZ



26. Solitine

A clean up and finishing solvent. Ideal to even out and smooth the surfaces of wax patterns.



59-1577	8 OZ
---------	------



27. Disclosing Wax

A creamy type soft wax for repair of superficial imperfections in wax patterns. This wax helps detect high spots or cavities. Easy to apply with finger or a spatula.



59-1578	2 OZ
---------	------

28. Red Utility Wax Sheets

An all purpose wax for filling small imperfections and applying sprue to sprue bases. Melts at 173° F and is flexible at room temperature. **Sold 5 sheets/bx.**

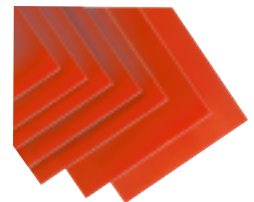

ITEM #	DESCRIPTION
59-1145	WAX SHEETS- 3" X 6" X 3/16"

CNC Machinable Waxes

Machinable • Carvable • Ideal for Checking Setups

Color Blue: Shore D Hardness 50

A highly cost efficient way to check setups on NC and CNC machines. This tough durable wax is also used to form fiberglass production tools for making jigs and fixtures and for a variety of prototype applications. Can be easily drilled, tapped, turned or milled without the need of cutting fluids. This product creates additional cost savings by extending tool life. Sold by the pound in blocks, bars and squares. Call for specifications and prices.

The logical Alternatives to Expensive Prototype Injection Dies

Color Red: Shore D Hardness 43

A uniquely machinable investment casting wax. Ideal for prototype work or short run part requirements. Allowing for cast metal shrinkage, the wax is machined as an exact duplicate of the desired part, then invested and melted out cleanly with virtually no residue. The cost savings are substantial because the need for injection dies is eliminated. Sold by the pound in blocks, bars and squares. Call for specifications and prices.



matt

29. Wax Ring Tubes

Pre-formed special profile wax tubes, in various sizes, get you started quickly on creations with intricate designs. Available in solid round, tube or flat side tube, these can be easily cut to exact lengths using the miter box. One per package.

Sold each

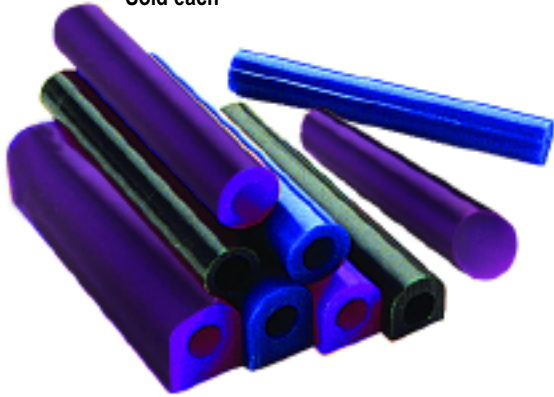

COLOR	CHARACTERISTICS	TEMP
■ BLUE	Flexible with regular hardness	240°F
■ PURPLE	Medium hard, with limited flexibility	240°F
■ GREEN	Hard, with no flexibility	240°F

ECC: Eccentric Center



OFF CENTER TUBES

1 1/16" Ø 5/8" Ø HOLE/ECC

ITEM #	COLOR	MATT#
59-2699	■ BLUE	2699
59-2700	■ PURPLE	2700
59-2701	■ GREEN	2701



FLAT SIDED TUBES

1 1/8" X 1" 5/8" Ø HOLE/ECC

ITEM #	COLOR	MATT#
59-2690	■ BLUE	2690
59-2691	■ PURPLE	2691
59-2692	■ GREEN	2692



FLAT SIDED TUBES

1 1/8" X 1 1/8" 5/8" Ø HOLE/ECC

ITEM #	COLOR	MATT#
59-2693	■ BLUE	2693
59-2694	■ PURPLE	2694
59-2695	■ GREEN	2695



FLAT SIDED TUBES

1 1/4" X 1 1/4" 5/8" Ø HOLE/ECC

ITEM #	COLOR	MATT#
59-2696	■ BLUE	2696
59-2697	■ PURPLE	2697
59-2698	■ GREEN	2698



SOLID ROUND BAR

7/8" Ø

ITEM #	COLOR	MATT#
59-2702	■ BLUE	2702
59-2703	■ PURPLE	2703
59-2704	■ GREEN	2704



SOLID ROUND BAR

1 1/16" Ø

ITEM #	COLOR	MATT#
59-2705	■ BLUE	2705
59-2706	■ PURPLE	2706
59-2707	■ GREEN	2707



SOLID ROUND BAR

1 5/16" Ø

ITEM #	COLOR	MATT#
59-2708	■ BLUE	2708
59-2709	■ PURPLE	2709
59-2710	■ GREEN	2710



ROUND HOLE

7/8" Ø 5/8" HOLE

ITEM #	COLOR	MATT#
59-2711	■ BLUE	2711
59-2712	■ PURPLE	2712
59-2713	■ GREEN	2713



ROUND HOLE

1 1/16" Ø 5/8" HOLE

ITEM #	COLOR	MATT#
59-2714	■ BLUE	2714
59-2715	■ PURPLE	2715
59-2716	■ GREEN	2716



ROUND HOLE

1 5/16" Ø 5/8" HOLE

ITEM #	COLOR	MATT#
59-2717	■ BLUE	2717
59-2718	■ PURPLE	2718
59-2719	■ GREEN	2719



matt

Wax Ring Tubes Kits

Kit Contains: Round : 2 pcs blue , 2 pcs Purple ; Flat Sided: 4 pcs blue, 4 pcs Purple
Sold each

ITEM #	MATT#
59-2720	2720



matt

30. Wax Bars & Slices

These carving waxes are formulated for professional carvers. Waxes are available in three grades with varying degrees of flexibility. Waxes are compounded to avoid contamination, flaws or porosity. Select from bars, blocks or slices.

Sold each

Wax Bars

Box includes pieces $\frac{1}{16}$ lb bars one color. Sizes $1\frac{7}{16}$ " x $1\frac{1}{8}$ " x $3\frac{1}{8}$ ".

Available in $\frac{1}{2}$ lb.



COLOR	ITEM #	SIZE	MATT#
■ BLUE	59-2753	$\frac{1}{2}$ LB	2753
■ PURPLE	59-2752	$\frac{1}{2}$ LB	2752
■ GREEN	59-2751	$\frac{1}{2}$ LB	2751

Wax Bar Kit

Box includes pieces $\frac{1}{16}$ lb bars; one of each blue, purple and green.

Sizes $1\frac{7}{16}$ " x $1\frac{1}{8}$ " x $3\frac{1}{8}$ ".

Available in $\frac{1}{2}$ lb.

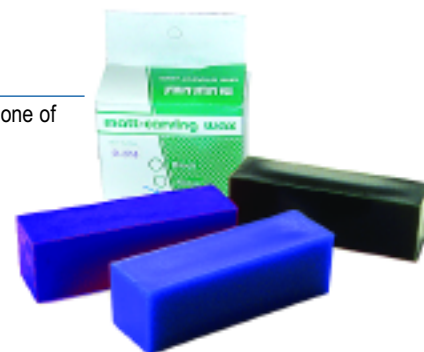

ITEM #	SIZE	MATT#
59-2750	$\frac{1}{2}$ LB	2750

Wax Blocks

$\frac{1}{2}$ lb : $1\frac{7}{16}$ " X $3\frac{1}{8}$ " X $3\frac{1}{8}$ "

1 lb : $1\frac{7}{16}$ " X $3\frac{1}{8}$ " X $6\frac{1}{2}$ "

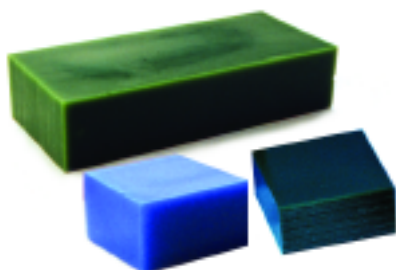

COLOR	$\frac{1}{2}$ LB	MATT#	1 LB	MATT#
■ BLUE	59-2757	2757	59-2762	2762
■ PURPLE	59-2756	2756	59-2761	2761
■ GREEN	59-2755	2755	59-2760	2760

Wax Slices-Thick

Size $1\frac{7}{16}$ " x $3\frac{1}{8}$ " assorted thickness from $\frac{1}{8}$ " to 1". Pkg 1 lb.

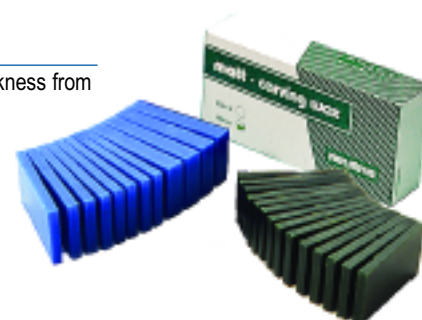

COLOR	1 LB	MATT#
■ BLUE	59-2772	2772
■ PURPLE	59-2771	2771
■ GREEN	59-2770	2770

Wax Slices-Thin

Size $1\frac{7}{16}$ " x $3\frac{1}{8}$ " assorted thickness from $\frac{1}{8}$ " to $\frac{1}{2}$ ". Pkg $\frac{1}{2}$ lb.

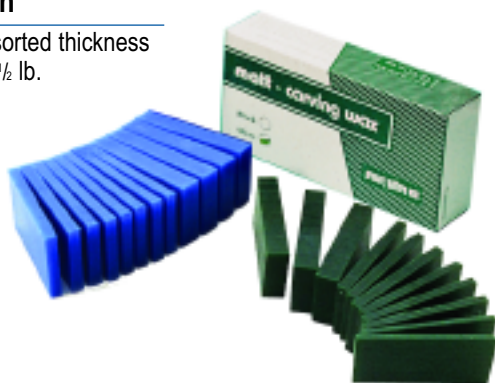

COLOR	ITEM #	SIZE	MATT#
■ BLUE	59-2767	$\frac{1}{2}$ LB	2767
■ PURPLE	59-2766	$\frac{1}{2}$ LB	2766
■ GREEN	59-2765	$\frac{1}{2}$ LB	2765

Bracelet Wax Blank

Create your own designs in a variety of shapes. From one blank style you can create round, oval or square bracelets in various designs. Size 6" long.

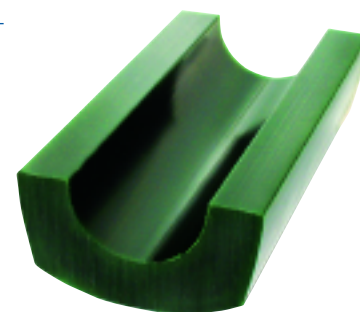

COLOR	ITEM #	MATT#
■ BLUE	59-2899	2899
■ PURPLE	59-2898	2898
■ GREEN	59-2897	2897

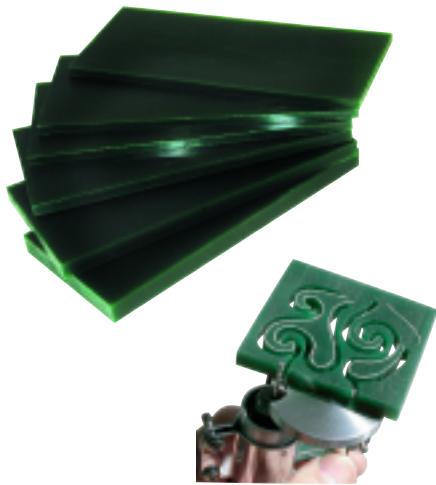

matt 31. Precision Wax Tablets

These innovations provide jewelry designers and model makers with large, flat, very smooth surfaces for designing jewelry directly on to carving wax. Tablet size 6" x 2⁵/₈".

Each Tablet Set Contains:

- Set A :4.5mm (3ea), 6mm(1), 8mm(1), 10.5mm(1)
- Set B :4.5mm (4ea), 6mm(3ea)
- Set C :8mm (2ea), 10.5mm(2ea)*
- Set D :4.5mm (8ea)
- Set E :6mm (6ea)
- Set F :15mm (1ea), 22mm(1ea)

ITEM #	DESCRIPTION
59-2779	SPECIAL SET 2779*

* To order please specify color, size and thickness.

COLOR	ITEM #	TYPE	MATT#	COLOR	ITEM #	TYPE	MATT#
■ BLUE	59-2773	SET A	2773	■ BLUE	59-2784	SET D	2784
■ PURPLE	59-2774	SET A	2774	■ PURPLE	59-2785	SET D	2785
■ GREEN	59-2775	SET A	2775	■ GREEN	59-2786	SET D	2786
■ BLUE	59-2776	SET B	2776	■ BLUE	59-2787	SET E	2787
■ PURPLE	59-2777	SET B	2777	■ PURPLE	59-2788	SET E	2788
■ GREEN	59-2778	SET B	2778	■ GREEN	59-2789	SET E	2789
■ BLUE	59-2781	SET C	2781	■ BLUE	59-2790	SET F	2790
■ PURPLE	59-2782	SET C	2782	■ PURPLE	59-2791	SET F	2791
■ GREEN	59-2783	SET C*	2783	■ GREEN	59-2792	SET F	2792

* Precision Wax Tablets for CAD/CAM

Special wax tablets for CAD/CAM machining Prototype designs with high precision and excellent detail. Tablets measure 6" x 2⁵/₈". Assortment contains 8mm and 10mm (2ea)

- GREEN 59-2783 SET C* #2783

matt 32. Miter Box Set

A fixture for sawing wax bars, rods or tubes to precise lengths. A stop/ lock allows you to cut several pieces accurately.

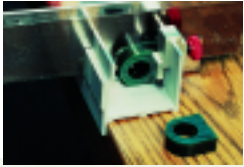

Kit Includes: Aluminum extruded miter box. Hand saw and stop lock



ITEM #	DESCRIPTION
59-2920	2920 MATT MITER BOX SET

matt 33. Wax Routing Bur

A carbide bur with special cutting flutes that leave a smooth finish. Use with a Matt Trimmer to cut designs in wax tablets.



ITEM #	DESCRIPTION
59-2885	2885 MATT CARBIDE BUR

34. Wax Kleen

An easy to rub on organic solution that gives wax patterns a very smooth surface before casting. Experience a high quality finish on cast product.



ITEM #	DESCRIPTION
59-1579	WAX KLEEN 4 OZ
59-1580	WAX KLEEN 8 OZ

matt 35. Ring Tube Sizer

Enlarge the finger size of wax models evenly and accurately. Slide this tool through the hole in the wax ring tube and rotate clockwise. The embedded steel blade will scrape the inner wall to enlarge the hole. Size #5-12.



ITEM #	DESCRIPTION
59-2890	2890 US SCALE
59-2891	2890-E EURO STYLE SCALE



matt



36. Mini Lathe with Gauge

A hand held versatile lathe. Assembles directly to your Foredom handpiece #30 for turning rods of carving wax. Easy to produce beads, bezels, and custom articles. Includes a precision gauge to achieve exact dimensions.

Kit Includes: A cutting tool, 2 cutting tool blanks, 3 collets, 3 pc blade set, gauge, sample wax and instruction book (HP and cable are not included)



59-2802



59-2804

ITEM #	DESCRIPTION
59-2803	2803 MATT MINI LATHE
59-2802	2802 CENTERING TOOL
59-2804	2804 GAUGE ONLY
59-2801	2801 S.S.BLADES SET/ 3
59-2830	2830 HOLDING COLLET
59-2835	2835 MILLING TABLE ONLY
59-2845	2845 TOOL SQUARE END



37. Shaper

An accessory that fits to your Foredom handpiece #30. Made in aluminum with a steel table support. Includes a fence that regulates the cutting depth for safe working.

Kit Includes: Bracelet template, rotary file, 2 slices wax blanks and instructions. (Handpiece and cable are not included)



59-2886

ITEM #	DESCRIPTION
59-2895	2895 MATT SHAPER
59-2886	2886 ROTARY FILE



38. Trimmer

Use with Foredom handpiece #30. Features an adjustable work platform for different angles. Enables you to precisely file shapes flat or curved. May be used for channel cutting.

Kit Includes: Rotary file, ring template, 3 different color wax tubes and instructions (Handpiece and cable are not included)



ITEM #	DESCRIPTION
59-2880	2880 MATT TRIMMER-KIT



59-1727



Wolf™ Wax Trimmer

- Mill, route or size ring blanks
- Fit on to a #30 handpiece (not included)
- Positions work at 90° for shaping and sizing

59-1727 WOLF™ WAX TRIMMER



59-1728

Wolf™ Adjustable Wax Trimmer

- Adjustable table with lock (75 x 75 x 67mm)
- Fit on to a #30 handpiece (not included)
- Positions work at 0-45° for milling and shaping

59-1728 WOLF™ ADJUSTABLE WAX TRIMMER



matt 39. Wax Rods

Wax rods for use in the mini lathe. All rods have 1/4" center holes for the holding collets. Four pieces 1 1/2" long per color.

Sold bx/4pcs

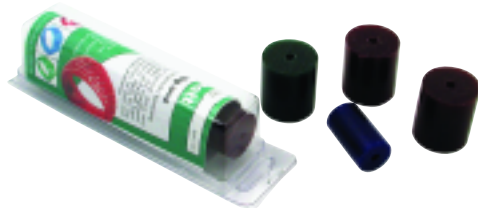

COLOR	Ø 1 5/16"	MATT#	Ø 1 3/32"	MATT#	Ø 7/8"	MATT#
■ BLUE	59-2810	2810	59-2815	2815	59-2820	2820
■ PURPLE	59-2812	2812	59-2817	2817	59-2822	2822
■ GREEN	59-2811	2811	59-2816	2816	59-2821	2821

matt 40. Reamer

This wax reamer consists of a precision ground guide rod with a lock nut to clamp the carbide tool. Two tools are provided, one to shave off a thin film of wax to leave a perfectly smooth surface and the other is a boring bit that allows you to enlarge the bore of the wax tube. Engraved lines on the tool are provided for setting the dimension.



ITEM #	DESCRIPTION
59-2887	2887 MATT REAMER

matt 41. Wax Gun Kit

Do wax weaving, macrame, and more. Use this lightweight wax extruder with a thermostatic control for creating jewelry designs. Easy to load wax cartridges. Accurate flow with your thumb control. Kit is complete and ready to use.

Kit includes gun, book, two brass nozzles (one small, one large) nozzle changing wrench and 15 wax cartridges in three grades, soft, medium and hard. Size 1 7/16" x 3 1/8" assorted thickness from 1/8" to 1/2". Pkg 1/2 lb.



ITEM #	DESCRIPTION
59-2945	955 GUN KIT 110V
59-2946	955/220 GUN KIT 220V
59-2947	CA951/3 MATT EXTRA TIP-SMALL
59-2948	CA951/4 MATT EXTRA TIP-LARGE

matt 42. Gold Collector

Made of high impact plastic, with a removable plexiglass shield, to provide a convenient enclosure for working of precious metals. Collects articles of gold and other precious metals for easy retrieval. Also protects eyes, skin and clothing while drilling, grinding and brushing.

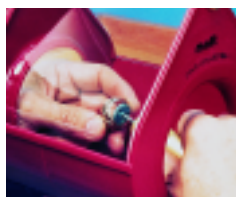

ITEM #	DESCRIPTION
59-3200	3200 GOLD COLLECTOR

matt Wax Pellets for Matt Gun

These convenient wax pellets load directly into the gun.

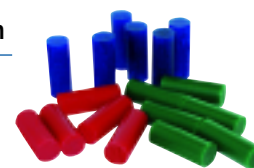

COLOR	PK/20	MATT#	PK/130	MATT#
■ BLUE	59-2951	951/1	59-2956	951/6
■ GREEN	59-2952	951/2	59-2957	951/7
■ RED	59-2955	951/5	59-2958	951/8



matt 43. Techniques of Jewelry Design

A full color 152 page book presents a comprehensive resource for designers and model makers. Each chapter explains projects with clear illustrations, color rendering and gemstone setting by professional jewelers.

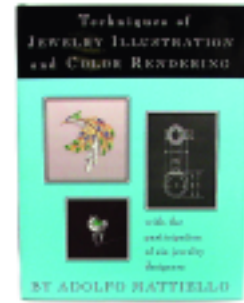

ITEM #	DESCRIPTION
59-3100	5100 BOOK & SET OF FIVE TEMPLATES
61-1013	1522 BOOK- TECHNIQUES OF JEWELRY (BOOK ONLY)
59-3110	5110 SET OF FIVE TEMPLATES ONLY

Individual Templates

ITEM #	DESCRIPTION
59-3102	5102 TEMPLATE #1 - STONE
59-3103	5103 TEMPLATE #2 - SIGNET RING
59-3104	5104 TEMPLATE #3 - BALLERINA RING
59-3105	5105 TEMPLATE #4 - FANCY RING
59-3106	5106 TEMPLATE #5 - RING SIDE VIEW

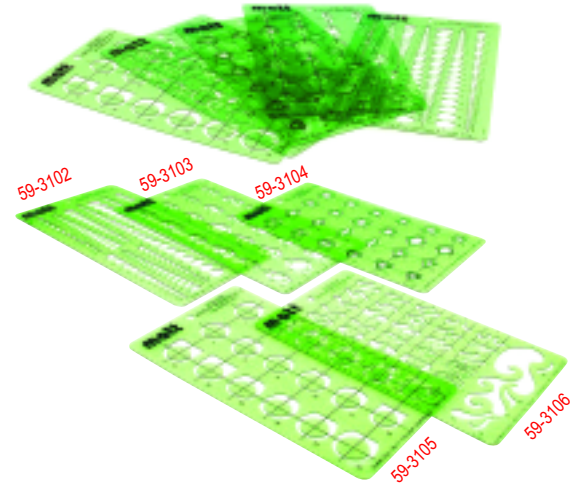

matt 44. Creative Setting Kit

Jewelry designer Adolfo Mattiello in his book "How to Create Settings in Metal Wire and Wax" illustrates a step by step guideline with drawings explaining the process. The 8" x 11" plastic laminated book has 32 pages with 250 detailed illustrations. Additionally, the templates provided enhance your stone setting and positioning ability.



ITEM #	DESCRIPTION
59-3112	2852 CREATIVE SETTING KIT
61-1012	2851 BOOK- HOW TO CREATE SETTINGS (BOOK ONLY)
59-3113	2853 TEMPLATE ROUND SETTING
59-3114	2854 TEMPLATE FOR OVAL, MARQUISE SETTINGS

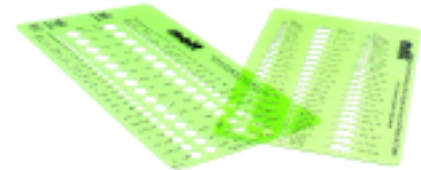

matt 45. Ring Template

Easy to use when designing the outlines of ring sizes for ladies or gents. Made in unbreakable plastic, it includes 18 of the most popular and unusual designs. Includes instructions.

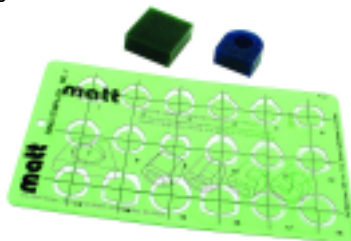

ITEM #	DESCRIPTION
59-3115	2855 RING TEMPLATE

matt 46. Bracelet Template

Enables layout with accuracy and symmetry. Made in durable plastic with precise milled shapes, easy to trace round, oval or square bracelets in all sizes. Includes instructions.

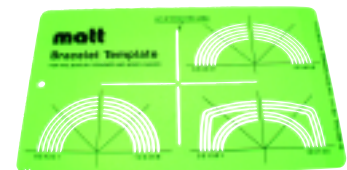

ITEM #	DESCRIPTION
59-3116	2896 BRACELET TEMPLATE



Wolf® Precision Wax Carvers

The perfect tool, with a precise profile - for every wax carving task. Wolf Precision Wax Carvers are a set of 18 tools customized to meet your specific carving needs. Every tool is finely crafted from alloy tool steel, tempered and burnished. Each of the 18 tools are shaped to perfection, color coded and numbered for identification. Every set is delivered in an attractive plastic cannister, together with a full color instruction booklet with more than 100 illustrations.



- A. Use back edge of the knife as scraper.
- B. The beveled edge of the knife is ideal for shaving wax.
- C. Knife tools #3 & #7 are carving, shaving and scraping tools.
- D. Use tool #4 to relieve corners of a seat.
- E. Use the tapered triangle tool #12 to refine windows.
- F. The Concave / Convex tool #16 is used to round forms.
- G. Hollowers #5, #8 & #17 Rake Hollowers, #6, #9 & #18 are used to refine concave surfaces.



2004 AJM
Innovation
Award
Winner



Wolf™ Wax Trimmer

- Mill, route or size ring blanks
- Fit on to a Foredom #30 handpiece
- Positions work at 90° for shaping and sizing

59-1727 WOLF™ WAX TRIMMER

ITEM #	DESCRIPTION
59-1701	TOOL #1 - SCRIBE
59-1702	TOOL #2 - SMALL TOOL 90°
59-1703	TOOL #3 - CARVING KNIFE
59-1704	TOOL #4 - DIAMOND POINT
59-1705	TOOL #5 - HOLLOWER MEDIUM
59-1706	TOOL #6 - RAKE HOLLOWER MEDIUM
59-1707	TOOL #7 - DETAILING KNIFE
59-1708	TOOL #8 - HOLLOWER TOOL SMALL
59-1709	TOOL #9 - RAKE HOLLOWER SMALL
59-1710	TOOL #10 - MEDIUM 90° / SAFETY EDGE
59-1711	TOOL #11 - PAVILION TOOL / SAFETY EDGE
59-1712	TOOL #12 - TAPERED TRIANGLE
59-1713	TOOL #13 - ROUNDING SMALL
59-1714	TOOL #14 - ROUNDING MEDIUM
59-1715	TOOL #15 - UNDERCUTTING
59-1716	TOOL #16 - CONCAVE/CONVEX
59-1717	TOOL #17 - HOLLOWER LARGE
59-1718	TOOL #18 - RAKE HOLLOWER LARGE
59-1719	PLASTIC CONTAINER FOR 59-1725
59-1722	SET- 6 PCS (#1-6)
59-1723	SET- 6 PCS (#7-12)
59-1724	SET- 6 PCS (#13-18)
59-1725	SET- 18 PCS (#1-18)
61-1132	WAX CARVING INSTRUCTION BOOKLET

SEE PAGE #38



KerrLab 47. Ultra Waxer

The Ultra-Waxer includes the Control Unit and the Ultra-Spatula with one Heating Tip (Small PKT Blue Tip), attached Holder for the Ultra Spatula and extra Heating Tips, Foot Control, Clear Protective Cover and complete operating instructions.

ITEM #	DESCRIPTION
59-1581	BUILT-IN ULTRA WAXER 110V SM PKT
59-1582	BUILT-IN ULTRA WAXER 220V SM PKT
59-1583	CORD HANDLE FOR ULTRA SPATULA

Spare Ultra Spatula

ITEM #	DESCRIPTION
59-1586	SM PKT
59-1587	LG PKT
59-1588	BEAVER TAIL
59-1589	SM #7
59-1590	LG #7
59-1591	NEEDLE
59-1592	1/2 HOLLENBACK
59-1593	SM DENTURE
59-1594	LG DENTURE
59-1595	DENTURE SPOON



KerrLab 48. Mastertouch™

Versatile wax pen offering excellent wax control in pattern build-up, denture applications, and spruing. Exclusive feature offers instant tip heating and cooling when used with the optional foot control.

Features: Ergonomic handpiece, 2 tips included (21878 & 21887), Temperature range: 66°C / 150°F to 538°C / 1000°F. Dual voltage unit.

ITEM #	DESCRIPTION
59-1602	MASTERTOUCH -DELUXE WITH F/C
59-1603	MASTER TOUCH TIP KIT- 15 PCS
59-1604	MASTERTORCH HANDPIECE
59-1605	MASTERTORCH FOOT CONTROL



Mastertouch™ Tips

Complete tip selection featuring Nichrome wire tips with immediate heat availability and rapid cooling. Tips have snap-in design that allows easy removal.



ITEM #	DESCRIPTION
59-1608	# A 21885
59-1609	#B 21875
59-1610	#C 21874
59-1611	#D 21879
59-1612	#E 21878

ITEM #	DESCRIPTION
59-1613	#F 21877
59-1614	#G 21876
59-1615	#H 21780
59-1616	#I 21888
59-1617	#J 21887

ITEM #	DESCRIPTION
59-1618	#K 21884
59-1619	#L 21883
59-1620	#M 21882
59-1621	#N 21881
59-1622	#O 21880



49. Smoothy Flakeless Wax Finisher

Pencil point torch of heated air. Ideal for blending uneven surfaces without actually touching the wax. Uses butane fuel. UL registered. When the tip is removed it may be used as a mini torch for light soldering and repair work. Temp. 2300°F/1260°C.



ITEM #	DESCRIPTION
59-1625	FLAKELESS WAX FINISHER



50. Deluxe Wax Mandrel Set

Versatile ring mandrel wax designing system.

Full Size Sleeve Set

10 full size ring sleeves (4-13).

Half Size Sleeve Set

Set of 10 Half size ring sleeves. (5-1/2 to 12-1/2)



ITEM #	DESCRIPTION
59-1626	FULL SIZE MANDREL SET
59-1627	HALF SIZE MANDREL SET

51. Speedy Wax Pen

Handy, cordless pocket tool for extra convenience. Useful in nearly every wax modeling task, carving, shaping and quick touch ups. General wire form tip for all wax applications. 1.5V, AA alkaline batteries (included). Two different temperature pens high or low.



ITEM #	DESCRIPTION
59-1641	PEN WITH ONE TIP - HIGH TEMP
59-1642	PEN WITH ONE TIP - LOW TEMP
59-1643	ONE TIP ONLY
59-1644	TWO TIP SET
59-1645	THREE TIP SET

52. Alcohol Lamp

Glass bowl lamp with a wick and a safety cap. Bowl holds 4 oz. of fuel. Faceted sides of the bowl allow it to be inclined to an angular position.



53. Wax Carver's Tool Set

The most complete set of carvers for the professional wax modeler. Seven (#1-#7) well balanced, polished and tempered steel tools for creative carving and design versatility. All tools are 6" long and on a hardwood stand that has a sharpening stone attached.

ITEM #	TYPE
59-1730	CARVER TOOL SET

Individual Carvers

ITEM #	TYPE
59-1731	CARVER #1
59-1732	CARVER #2
59-1733	CARVER #3
59-1734	CARVER #4

ITEM #	TYPE
59-1735	CARVER #5
59-1736	CARVER #6
59-1737	CARVER #7
59-1738	SPATULA

ITEM #	DESCRIPTION
59-1766	ADJUSTABLE WICK
59-1767	LARGE WICK
59-1768	REPLACEABLE WICK



54. Digital Wax Carver

High precision digital control for wax modelling, carving, shaping or sizing. Its compact size makes it easy to carry and its simple design and functions makes this unit user friendly. The stable power supply provides for accurate working temperature and the memory function records the prior working temperature even after turning the off/on power switch.

Unit Includes:

Control Box, Electric Carver, Carver Holder, Two Tips and AC Cord

- Temperature: 122~392°F • Power: 110/220V
- Dimension: 76 X 119 X 63mm • Wt.: 1.2 lb



ITEM #	DESCRIPTION
59-1791	DIGITAL WAX CARVER 110V / 220V

Extra tips available

55. Wax Worker

A versatile tool with excellent wax control for pattern making, repairing and spruing. Variable temperature settings suitable for different wax types. Ergonomic handpiece has instant heat up. Replaceable tips with a single set screw. May also be used for carving, smoothing and texturing.



ITEM #	DESCRIPTION
59-1745	110V / 60 HZ WITH ONE TIP
59-1746	220V / 50HZ WITH ONE TIP
59-1747	REPLACEMENT HANDPIECE
59-1748	REPLACEMENT TIP ONLY

56. Wax Heating Tray

The wax tray keeps three different waxes melted in separate compartments, two small and one large. Features includes a hinged cover, thermostat dial control and pilot lamp. Temperature is adjustable to a maximum of 280°F. Useful for the model maker while assembling trees.



ITEM #	DESCRIPTION
59-1761	WAX HEATING TRAY 110V / 60 HZ
59-1762	WAX HEATING TRAY 220V / 50HZ

57. Wax Dipping Pot

- Precise temperature control
- Protection against over heating
- Fast temperature setup
- Lid helps to retain heat and prevent contamination
- Dimension: 120 X 150 X 80mm
- Wt.: 1.6 lb



ITEM #	DESCRIPTION
59-1743	WAX DIPPING POT 110V / 60 HZ

58. Precision Waxer

Heavy duty industrial waxer for wax modeling, carving, shaping or sizing. Accurate temperature control with nine different settings. Slim, lightweight handpiece with changeable tips for the most challenging work. Features include pilot light, on/off switch, handpiece and three assorted tips.

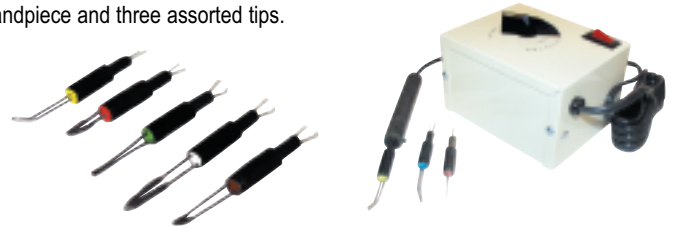

ITEM #	DESCRIPTION
59-1751	WAXER -110V / 60 HZ- WITH 3 TIP
59-1752	WAXER -220V / 50 HZ- WITH 3 TIP
59-1753	EXTRA HANDPIECE
59-1754	CORD & HANDLE
59-1755	YELLOW WIDE GROOVE
59-1756	BLUE NARROW BEND
59-1757	ORANGE FLAT
59-1758	GREEN NEEDLE
59-1759	BLACK SPRUE BURNING
59-1760	RED WIDE

59. Digital Waxing Unit

- Thermostat controlled temperature
- Easy switch over from C to F or vice versa
- On/Off switch at the rear of unit
- One well: 3 7/8" x 1 5/8"; Three wells: 1 5/8" x 1"

- Dimensions 185 x 115 x 65 mm
- Wt 1.2 lb



ITEM #	DESCRIPTION
59-1740	DIGITAL WAXING UNIT 110V/60HZ
59-1741	DIGITAL WAXING UNIT 220V/50HZ

60. Bouron® Wax Tools

These unique tools were designed by a master wax carver to create a masterpiece everytime. Precision pave layout and exact prong positioning are two skillful techniques that these tools perfect. A complete set consists of 16 tempered steel tools on a polished wooden stand. Sizes from 0.25-4.00mm in increments of 0.5mm

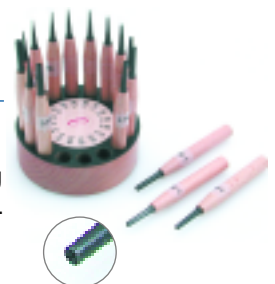

ITEM #	DESCRIPTION
59-1764	BOURON WAX TOOL SET -16 PCS



61. WAX-A-SIZER

Designed by a master jeweler the "WAX-A-SIZER" makes it easier to precisely size the bores of standard wax tubes. Unlike other sizers which tend to leave the bores tapered, the WAX-A-SIZER is unique as it has a pilot to guide the cutting head accurately. Made in aluminum the tool comes as a complete set with cutting heads calibrated from size #5 to #14. No more guess work. Select the right size and finish the bore. It takes less than 30 seconds to do the job.



ITEM #	DESCRIPTION
59-1781	WAX-A-SIZER COMPLETE SET

62. Mandrel Tapered / Stepped

Smooth polished mandrels, tapered and stepped are mounted on a sturdy steel base. Mandrel rotates for easy creation of wax wire designs. Suitable for ring sizes 4-13.



ITEM #	DESCRIPTION
59-1771	WOOD TAPERED MANDREL WITH BASE
59-1772	STEP TAPERED MANDREL WITH BASE

63. Wax Rasps

A fast cutting tool for initial wax forming. Novel design that allows shavings to fall away without clogging. Available in round or square. 6" overall length.

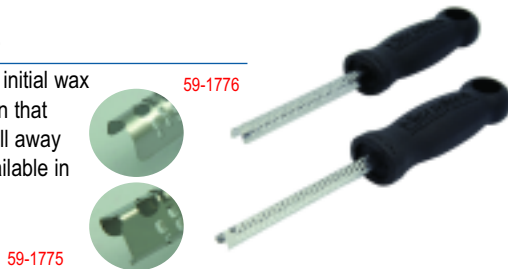

ITEM #	DESCRIPTION
59-1775	WAX RASP-SQUARE
59-1776	WAX RASP-ROUND

64. Designers Templates- Japan

Designers templates for the professional jewelers.

- A-1: Marquise-Pear-Emerald
- A-2: Heart-Square-Rectangular
- A-3 Half Round Ring 3D
- A-4 Wide Band Ring- 3D
- A-5 Diamond Round
- A-6 Ring Sizes
- A-7 Top View-Type A
- A-8 Top View Type B
- A-9 Clasps
- A-10 Diamond Oval

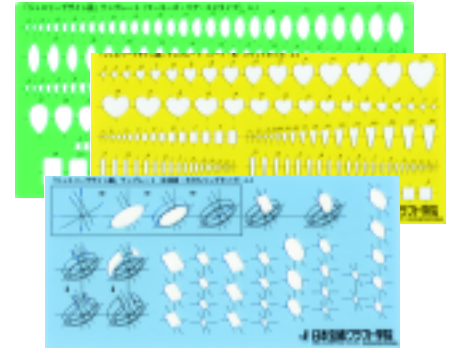

ITEM #	TYPE	ITEM #	TYPE
59-1801	# A-1	59-1806	# A-6
59-1802	# A-2	59-1807	# A-7
59-1803	# A-3	59-1808	# A-8
59-1804	# A-4	59-1809	# A-9
59-1805	# A-5	59-1810	# A-10

65. Double-End Vulcanite Files

Double-End Vulcanite Files have tooth forms especially designed for use on wax, plastic and other soft materials. One file has both coarse and fine cuts.



ITEM #	DESCRIPTION
33-1391	DOUBLE END FILES 8" - VALLORBE
33-1392	DOUBLE END FILES 8" - BAITER
33-1393	DOUBLE END FILES 8" - VALUE

66. Wax Detailer

An excellent tool for filing corners, intricate crevices and fine holes. Made of stainless steel, the points are tapered and have shallow cutting edges for smoothing. Available in a set of one fine and one extra fine. 6" overall length.

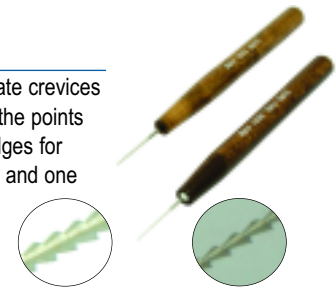

ITEM #	DESCRIPTION
59-1778	WAX DETAILER SET



WORK BENCHES

1. MO-50

A quality laminated top workbench with skirted legs. Three drawers and two slide out trays. Left and right arm rests with bench pin slot.



ITEM #	60-1013
MODEL	MO-50
DIMENSIONS	35-1/2" W X 21-1/2" D X 36" Ht.
WEIGHT	130 LBS

2. MO-35

A well constructed hardwood workbench with three side railing and skirted legs. Two storage drawers and two large slide out catch trays. Left and right arm supports, with a replaceable bench pin slot.

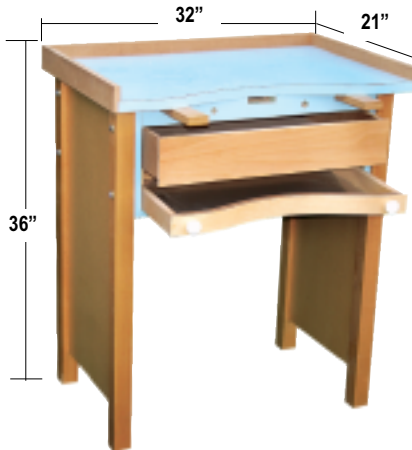

ITEM #	60-1011
MODEL	MO-35
DIMENSIONS	32" W X 21" D X 36" Ht.
WEIGHT	85 LBS

3. MO-40

Laminated top hardwood workbench with three side railing and skirted legs. Three storage drawers and two large slide out catch trays. Pre-drilled holes for mandrels. Left and right arm supports, with a replaceable bench pin slot.

Note: For work benches some assembly is required. All Benches will be shipped via Master Craft.

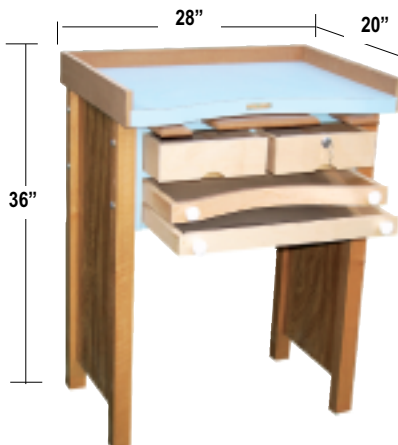

ITEM #	60-1012
MODEL	MO-40
DIMENSIONS	28" W X 20" D X 36" Ht.
WEIGHT	110 LBS

4. BN-250-100S

A top quality workbench of seasoned hardwood with side railing and full skirted sides and rear. Four drawers, a slide out tray with shelf, and lockable. Left and right arm supports, a replaceable bench pin slot and pre-drilled holes.

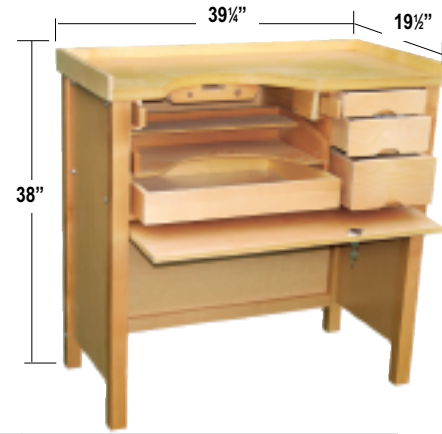

ITEM #	60-1020
MODEL	BN-250-100S
DIMENSIONS	39-1/4" W X 19-1/2" D X 38" Ht.
WEIGHT	110 LBS

5. BN-250

A top quality workbench of seasoned hardwood with side railing and full skirted legs. Four drawers and a slide out tray with shelf. Left and right arm supports, a replaceable bench pin slot and pre-drilled holes.



ITEM #	60-1018
MODEL	BN-250
DIMENSIONS	39-1/4" W X 19-1/2" D X 38" Ht.
WEIGHT	100 LBS

6. MC-Olympic

Hardwood constructed workbench, with a recessed metal plate. Three storage drawers and two aluminum catch trays. Includes a slide out work tray. Pre-drilled for mounting mandrels and a slot for bench pin.

MC-Olympic-Deluxe: Has an aluminum slot for a bench pin

60-1036: 5 draw organizer available.



ITEM #	60-1017	60-1050
MODEL	MC-OLYMPIC	MC-OLYMPIC- DELUXE
DIMENSIONS	36-1/2" W X 24-1/4" D X 38" Ht.	
WEIGHT	130 LBS	130 LBS

WORK BENCHES



7. WM

A top quality work bench of seasoned hardwood with full skirted sides and rear. Ample storage space with 15 spacious drawers and a catch tray.

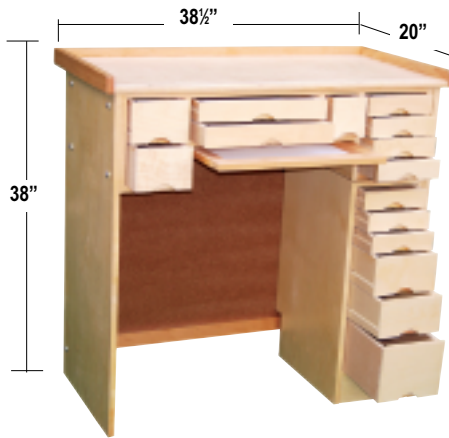

ITEM #	60-1022
MODEL	WM
DIMENSIONS	38-1/2" W X 20" D X 38" Ht.
WEIGHT	140 LBS

10. PN-100

Well crafted bench built to last. Seven side drawers, two top drawers and two sliding trays. Comfortable foot rest. Left and right arm rest with slot for bench pin. One layout shelf.



ITEM #	60-1023
MODEL	PN-100
DIMENSIONS	48" W X 22" D X 38" Ht.
WEIGHT	210 LBS

8. MO-60

Standard work bench of seasoned hardwood with skirted legs. Three drawers for storage of tools, one bottom drawer with metal pan and a pull-out tray for mandrels. Left and right arm supports, with a replaceable bench pin slot.

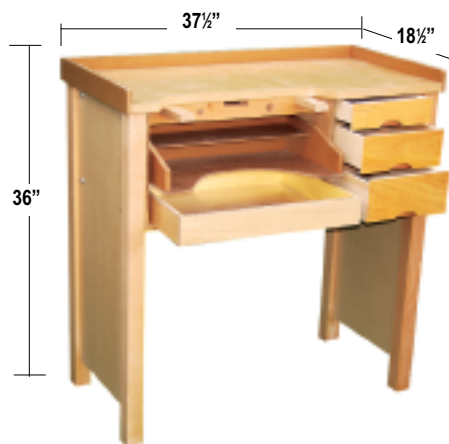

ITEM #	60-1014
MODEL	MO-60
DIMENSIONS	37-1/2" W X 18-1/2" D X 36" Ht.
WEIGHT	90 LBS

11. BN-260

Hardwood work bench full skirted for rigidity. Consists of three drawers and a pull out utility tray with two shelves. Pre-drilled holes for mandrels. Left and right arm supports, with a replaceable bench pin slot.



ITEM #	60-1019
MODEL	BN-260
DIMENSIONS	39-1/4" W X 19-1/2" D X 38" Ht.
WEIGHT	110 LBS

9. PW

Sturdy hardwood workbench with a recessed metal anvil and railing on three sides. Three storage drawers and two large slide out catch trays. Pre-drilled holes for mandrels. Left and right arm supports, with a replaceable bench pin slot.

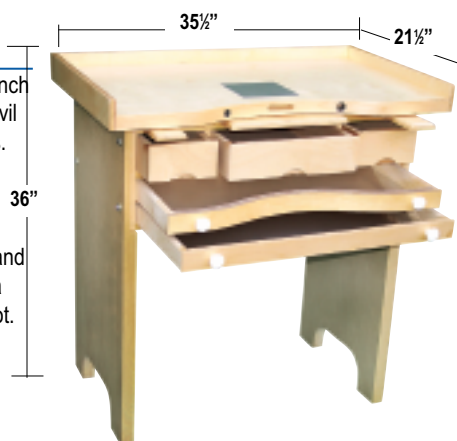

ITEM #	60-1021
MODEL	PW
DIMENSIONS	35-1/2" W X 21-1/2" D X 36" Ht.
WEIGHT	130 LBS

12. BN-60 / BN-60L

Sturdy wood benches in a steel frame construction. Features include two pull-out drawers. Lower drawer has a metal pan for bench sweeps.

Single : BN-60
Double : BN-60L

* Picture not shown



ITEM #	60-1015	60-1016*
MODEL	BN-60	BN-60L
DIMENSIONS	32-1/2" W X 16-1/4" D X 36" Ht.	65" W X 16-1/4" D X 36" Ht.
WEIGHT	68 lb	166 lb



WORK BENCHES

13. MO-10 / MO-20

A compliment to your workbench for easy organized storage. Free standing, may be placed conveniently anywhere in the shop.

3- drawer : MO-10
7- drawer MO-20

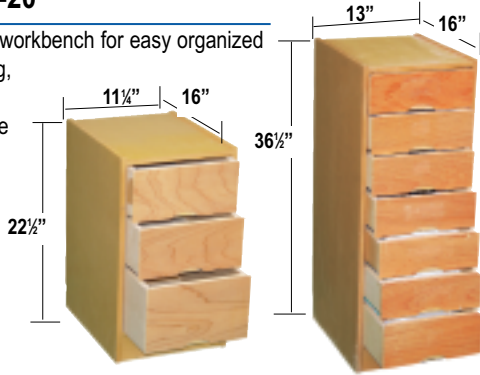

ITEM #	60-1031	60-1032
MODEL	MO-10	MO-20
DIMENSIONS	11-1/4" W X 16" D X 22-1/2"H	13" W X 16" D X 36-1/2" Ht.
WEIGHT	38 LBS	60 LBS

15. PN-110

Hardwood constructed workbench with 16 storage drawers and two aluminum catch trays. Pre-drilled for mounting mandrels with an aluminum slot for a bench pin and metal work plate.

Bench does not include organizer.

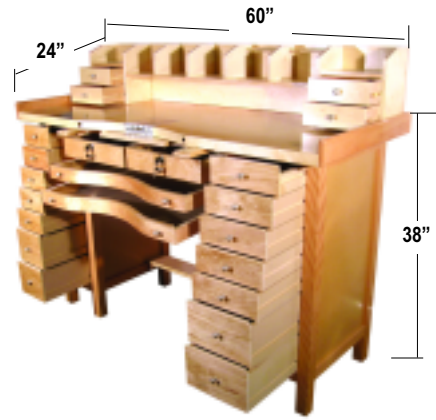

ITEM #	60-1045	60-1046
MODEL	PN-110	COUNTER TOP ORGANIZER
DIMENSIONS	60" W X 24" D X 38"H	59" W X 7" D X 10-1/2" Ht.
WEIGHT	310 LBS	18 LBS

14. PN-120

A well constructed formica counter top bench with 16 drawers and two aluminum sliding trays. Built in aluminum slot for a bench pin.

Bench does not include organizer.

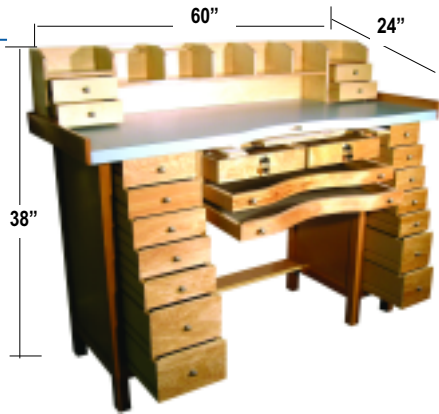

ITEM #	60-1047	60-1046
MODEL	PN-120	COUNTER TOP ORGANIZER
DIMENSIONS	60" W X 24" D X 38"H	59" W X 7" D X 10-1/2" Ht.
WEIGHT	310 LBS	18 LBS

16. Olympic-Grande

Hardwood constructed workbench with 12 spacious storage drawers and two aluminum sliding trays. Pre-drilled for mounting mandrels, with an aluminum slot for a bench pin.

High quality counter top organizer available.

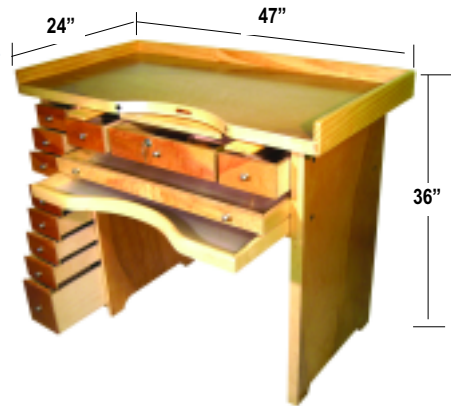

ITEM #	60-1048	60-1049
MODEL	OLYMPIC GRANDE	COUNTER TOP ORGANIZER
DIMENSIONS	47" W X 24" D X 36"H	46" W X 7" D X 10-1/2" Ht.
WEIGHT	210 LBS	18 LBS

COUNTER TOP ORGANIZER

High quality counter top organizer available for all models. Please ask for details.



*Note: For work benches some assembly is required.
All Benches will be shipped via Master Craft LA.*

17. Jewelers Bench Chair

- Sturdy, swivel tubular steel chair on heavy duty casters
- Adjustable rexine seat with padded lumbar support
- Seat adjusts 16" - 22" in height



60-1041



60-1042



60-1043

ITEM #	60-1041	60-1042	60-1043
MODEL	DELUXE	COMFORT	ERGONOMIC
DIMENSIONS	16" X 15" X 35"	450WX540DX860H	560WX520DX830H
WEIGHT	15 LBS	16 LBS	22 LBS



A Complete Package..... at an affordable price

The ZT thermal transfer labelling system enables you to print high quality professional jewelry tags from your computer. Design and personalise tags by selecting your own logos and fonts. Software is included to generate bar codes. The package includes everything you need to get started.

All you need to print.....

- ZT high efficiency thermal desk top printer
- User friendly software
- DDL & Driver (Microsoft Windows 95.98.NT 4.0, 2000,XP & Vista)
- 1000 Jewelry tags
- 98' Thermal transfer ribbon

ITEM #	DESCRIPTION
53-2001	COMPLETE PACKAGE



Ribbon (984ft)

ZT-1300, Zebra Z4M Plus, Zebra Z6M Plus, Zebra 105 SL, Zebra 105 SE, Zebra S600

53-2020



EZ-PEEL Labels



53-2130 0.438" X 0.625" Price \$ 135.00



53-2131 0.5" X 0.75"

Barbells

- Transparent Shanks
- Extra Strength high gloss 3 mil
- Standard core size 1"- 1000 tags per roll
- Pk/5000



Voyager Scanner MS9540

The ideal barcode scanner for high volume users. Decodes all standard 1D, RSS 14, RSS expanded bar codes. Comes with code gate data transmission technology. Features an automatic trigger and an adjustable stand.

53-2031



ZT SC125 Scanner

An economical scanner for retail applications. No warm up time. Easy plug and play installation with USB connection. Reads all commonly used barcode symbologies from contact up to a distance of 125mm.

53-2032



53-2140 0.437" X 0.875" Price \$ 190.00



53-2141 0.563" X 1.25"

Rattails

- Transparent Shanks
- Extra Strength high gloss 3 mil
- Standard core size 1"- 1000 tags per roll
- Pk/5000



53-2153 0.75" X 1.5"

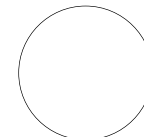

53-2163 1" Ø

Display Labels

- Transparent Shanks
- Extra Strength high gloss 3 mil
- Standard core size 1"- 1000 tags per roll
- Pk/5000



FINELY CRAFTED BOUTIQUE STYLE

Jewelry Pouches and Ring Boxes
with soft inner lining.
Available in two colors.

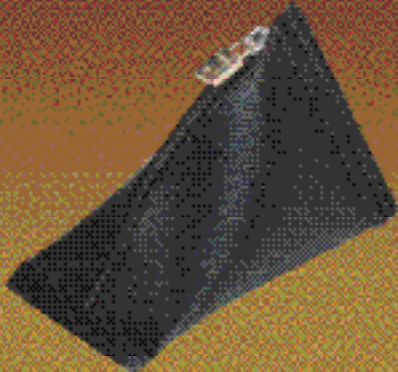

ITEM# 65-1011 COLOR **B**
ITEM# 65-1012 COLOR **R**
Jewelry Pouch 3 1/4" x 3 1/4" x 1 1/2"



ITEM# 65-1013 COLOR **B**
ITEM# 65-1014 COLOR **R**
Jewelry Pouch 4" x 2 3/4" x 3/8"



ITEM# 65-1015 COLOR **B**
ITEM# 65-1016 COLOR **R**
Jewelry Pouch 4 1/2" x 1 1/2" x 3 1/4"

THE GOLD COLLECTION



ITEM# 65-1017 COLOR **B**
ITEM# 65-1018 COLOR **R**
Mini Pouch 3 3/4" x 1 1/2" x 2"



ITEM# 65-1019 COLOR **B**
ITEM# 65-1020 COLOR **R**
Jewelry Spring Pouch 4" x 4" x 3/8"

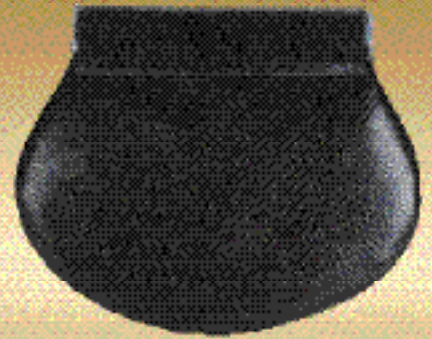

ITEM# 65-1021 COLOR **B**
ITEM# 65-1022 COLOR **R**
Jewelry Spring Pouch 5 1/4" x 4 1/2" x 3/8"



ITEM# 65-1023 COLOR **B**
ITEM# 65-1024 COLOR **R**
Jewelry Set Box 4 1/4" x 3 1/4" x 2 3/4"



ITEM# 65-1025 COLOR **B**
ITEM# 65-1026 COLOR **R**
Ring Box 2 3/4" x 1 3/4" x 2 1/2"



ITEM# 65-1027 COLOR **B**
ITEM# 65-1028 COLOR **R**
Ring Box 3" x 1 1/2" x 3 3/4"



Jewelry Not Included



FINELY CRAFTED BOUTIQUE STYLE

Jewelry Pouches and Ring Boxes
with soft inner lining.
Available in two colors.



ITEM# 65-1029 COLOR **B**
ITEM# 65-1030 COLOR **R**
Ring Box 2 3/4" x 2 3/4" x 1 1/2"

THE PLATINUM COLLECTION

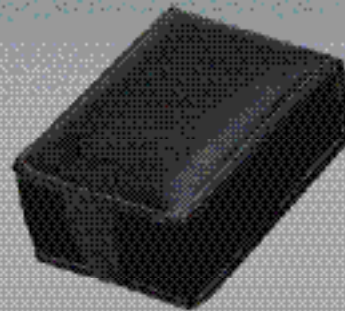

ITEM# 65-1031 COLOR **B**
ITEM# 65-1032 COLOR **R**
Bracelet Box 4 1/2" x 3 1/4" x 1 3/4"



ITEM# 65-1033 COLOR **B**
ITEM# 65-1034 COLOR **R**
Necklace Box 6" x 4 1/2" x 2"

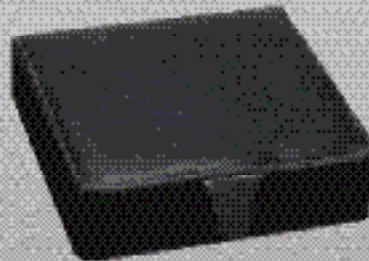

ITEM# 65-1035 COLOR **B**
ITEM# 65-1036 COLOR **R**
Jewelry Set Box 8" x 6" x 2 1/4"



ITEM# 65-1039 COLOR **B**
ITEM# 65-1040 COLOR **R**
Ring Box 3" dia. x 2"



ITEM# 65-1037 COLOR **B**
ITEM# 65-1038 COLOR **R**
Watch Case 4 3/4" dia. x 3 1/4"



ITEM# 65-1041 COLOR **B**
ITEM# 65-1042 COLOR **R**
Jewelry Set Box 6 1/2" dia. x 2 1/4"

*Jewelry Not Included

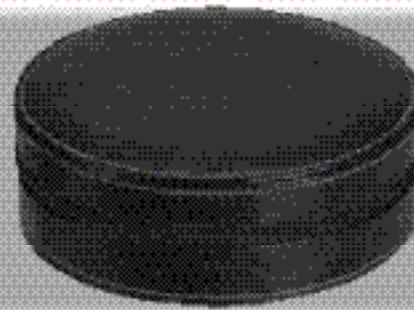

ITEM# 65-1043 COLOR **B**
ITEM# 65-1044 COLOR **R**
Jewelry Set Box 8" dia. x 2 3/4"



CONVERSION CHART

Weight- Mass

Troy to Metric

1 Grain	0.0648 Grams
1 Pennyweight	1.5552 Grams
1 Troy ounce	31.1035 Grams

Carat to Metric

1 Grain	0.648 Grams
1 Carat	200 Milligrams
1 Point	2 Milligrams

Avoirdupois to Troy

1 Ounce Avoirdupoir	0.914 Troy Ounce
1 Pound Avoirdupoir	14.5833 Troy Ounce

Avoirdupois to Metric

1 Grain	0.0648 Grams
1 Ounce Avoirdupoir	28.3495 Grams
2.2 Pounds Avoirdupoir	1 Kilogram

Carat to Avoirdupois

1 Carat	0.007 Ounces Avoirdupoir
---------	--------------------------

Linear

English to Metric

1 Mil	0.0254 Millimeters
1 Inch	25.4 Millimeters
1 Foot	0.3048 Meters
1 Yard	0.9144 Meters

Metric to English

1 Millimeter	0.03937 Inches
1 Centimeter	0.3937 Inches
1 Meter	39.37 Inches

Volume

English to Metric

1 Cubic Inch	16.387 Cubic Centimeters
1 Cubic Foot	0.0283 Cubic Meters
1 Cubic Yard	0.7646 Cubic Meters

Metric to English

1 Cubic Centimeter	0.06102 Cubic Inches
1 Cubic Meter	35.314 Cubic Feet

American to Metric

1 Fluid ounce	0.0296 Liter
1 Gill	0.1183 Liter
1 Pint	0.4732 Liter
1 quart	0.9464 Liter
1 Gallon	3.7854 Liter

Metric to American

1 Milliliter	0.0338 Fluid Ounces
1 Liter	1.057 Liquid Quart

Temperatures

Fahrenheit to Celsius

$$(F^{\circ} - 32) \div 1.8 = C^{\circ}$$

Celsius to Fahrenheit

$$(C^{\circ} \times 1.8) + 32 = F^{\circ}$$

Ring Sizes to Inches

0	0.458	7½	0.698
¼	0.466	8	0.714
½	0.474	8½	0.730
¾	0.482	9	0.746
1	0.490	9½	0.762
1½	0.506	10	0.778
2	0.522	10½	0.794
2½	0.538	11	0.810
3	0.554	11½	0.826
3½	0.570	12	0.842
4	0.586	12½	0.858
4½	0.602	13	0.876
5	0.618	13½	0.895
5½	0.634	14	0.911
6	0.650	14½	0.927
6½	0.666	15	0.944
7	0.682		

Sieve Sizes

No Plate	St/Ct	Ø	Dia. pt
0	200	1.10	½
1	175	1.15	
2	125	1.25	
3	100	1.35	1
4	80	1.45	
5	60	1.55	
6	48	1.70	
7	35	1.90	
8	30	2.10	
9	22	2.30	
10	18	2.50	
11	16	2.70	¾
12	13	2.90	⅝
13	10	3.10	10
14	8	3.30	12
15	6.5	3.50	15
16	5.5	3.70	17
17	4.75	3.90	19
18	4.25	4.10	22
19	3.70	4.30	25
20	3	4.50	30
21	2.5	4.70	40
22	2.22	4.90	45
23	2.00	5.10	50
24	1.67	5.30	60
25	1.54	5.50	65
26	1.43	5.70	70
27	1.33	5.90	75
28	1.25	6.10	80
29	1.11	6.30	90
30	1.00	6.50	1
31	1.00	6.70	1.10
32	0.83	6.90	1.2
33	0.77	7.10	1.3
34	0.71	7.30	1.4
35	0.65	7.50	1.55
36	0.59	7.70	1.70
37	0.54	7.90	1.85
38	0.51	8.10	1.95
39	0.47	8.30	2.15
40	0.54	8.50	2.20

Fractions to Millimeters

½	0.7938	⅓	11.9062
⅙	1.5875	½	12.7000
⅓	2.3812	⅔	14.2875
¼	3.1750	¾	15.8750
⅕	3.9688	⅘	16.6688
⅙	4.7625	⅚	17.4625

¼	6.3500	¾	19.0500
⅓	7.9375	⅚	20.6375
⅔	9.5250	⅞	22.2250
⅘	10.3188	⅞	23.8125
⅙	11.1125	1	25.4000

Gauge Sizes

#	US Std	BS Std
0	0.312	0.340
1	0.281	0.300
2	0.265	0.284
3	0.250	0.259
4	0.234	0.238
5	0.218	0.220
6	0.203	0.203
7	0.187	0.180
8	0.171	0.165
9	0.156	0.148
10	0.140	0.134
11	0.125	0.120
12	0.109	0.109
13	0.093	0.095
14	0.078	0.083
15	0.070	0.072
16	0.062	0.065
17	0.056	0.058
18	0.050	0.049
19	0.043	0.042
20	0.037	0.035
21	0.034	0.032
22	0.031	0.028
23	0.028	0.025
24	0.025	0.022
25	0.021	0.020
26	0.018	0.018
27	0.017	0.016
28	0.015	0.014
29	0.014	0.013
30	0.012	0.012

Melting Temp.

	F°	C°
Copper	1981	1083
Tin	450	232
Zinc	787	419
Sterling	1640	893
Silver	1761	961
10k Y. Gold	1665	907
10k W. Gold	1975	1079
14k Y. Gold	1615	879
14k W. Gold	1825	996
18k Y. Gold	1700	927
18k W. Gold	1730	943
Platinum	3224	1773
Palladium	2381	1555

Silver Solder

Melting Temp.	F°	C°
Hard	1365	741
Medium	1275	669
Soft	1150	621

KARAT	THOUSANDTH
14K	585
18K	750
20K	832
22K	917



3M®

3M® Cut & Polish Wheels	67
3M® Deburring Wheels	67
3M® Diamond Files	156
3M® Dusk Mask	244
3M® Flat Sanding Sticks	3
3M® Glue & Gel	266
3M® Quick-Fix Adhesive	266
3M® Scotch Brite Cloths	226
3M® Vetrap™ Tapes	227
3M® Flex Diamond Bands	5
3M® FX Polishing Wheels	66
3M® General Purpose Wheels	67
3M® Micro-Finishing Film Sheets	2
3M® Platinum Fre-Cut Sheets	2
3M® Professional Shop Rolls	4
3M® PSA Diamond Lapping Discs	2
3M® PSA Diamond Strips	3
3M® PSA Micro-Finishing Discs	3
3M® PSA Sanding Discs	2
3M® Radial Brushes	65
3M® Sanding Bands Sic/Alo/Ceramic	4
3M® Sanding Belts	7
3M® Sanding Sponges	60
3M® Scotch Brite Cloths	106
3M® Scotch Brite Pads	60
3M® Shop Rolls	3
3M® Silicon Carbide Stikit Rolls	4
3M® Anti-Tarnish Strips & Anti-Tarnish Shield	104
3M® Trizact Sanding Bands/Rolls	5
3M® Unitized Wheels	66
3M® Wet or Dry Polishing Paper	2
3M® Wet or Dry Sheets	2

A

Abrasives	2-22
Accurate Diamond Gauge	166
Acetylene Air Kit	302
Acrylic Bur Stand	78
Adalox Discs	8
Adapters and Wheel Flanges	65
Adhesives	266
Adjustable Scraper	43, 261
Adjustable Graver Handle	181
Air Acetylene Tips	302
Air Compressor	146
Air Purifiers	230
Aluminum Back Plates	23
Aluminum Mold Frames	88
Aluminum Ring Sticks	170
Anvils	186
Arabic Gum	31
Arbors	227
Arkansas Stones	26
Artifex Elastic Bond Wheels	67
Artifex Inside Ring Polishers	64
Asymmetric Fluorescent Lamp	191
Attack® Epoxy Solvent	266
Automatic Center Punches	277

B

Bar Coding and Labeling	348
Batteries - Watch	324
Bead Aws	31

Bead Boards	31
Beading Cords -Silk/Wire	28,30
Bead Reamer Set	31
Benches	345
B&L® Watch Makers Loupes	321
B&L® Coddington Loupes	193
B&L® Folding Pocket Magnifiers	192
B&L® Hastings Triplet Loupes	193
B&L® Hasting Triplet/Magnifiers	192
B&L® Illuminated Coddington Loupe	193
B&L® Illuminated Stand Magnifier	193
B&L® Magna Visor	196
B&L® Measuring Scales	192
B&L® Spectacle Loupes	198
Badeco® Hammer Handpieces	161
Badeco® Rotary Handpieces	160
Baiter Escapment Files	155
Baiter Files	154,155
Baiter Needle Files & Handles	153
Baiter Swiss Precision Files	152
Baker Gauge	165
Ball Pein Hammers	187, 320
Band Vise	317
Bar Racks for Ultrasonic Cleaners	104
BaseMate®	93
Batters® Hard Soldering Flux	272
Beading Blocks	264
Beading Needles	31
Beading Tool Sets	264
Beeswax-Synthetic	139
Belt Sander	44
Bench Drill	134
Bench Mounted Saw Table	248
Bench Torch Holders	305
Bench Brush -Straight Soft	56
Bench Duster Brush	52
Bench Horn Anvil & Block	40
BenchMate-GRS	48
Bench Shears with Handle	222
Bergeon® Case Opener	316
Bergeon® Crystal Press	316
Bergeon® Jaxa Case Wrench	316
Bergeon® Key for Opening Watches	316
Bergeon® Micro-Shock Case Opener	319
Bergeon® Plier Type Pin Remover	316
Bergeon® Watchmakers Screwdrivers	316
Bergeon® Waterproof Tester	316
Bergeon® Satin Finish Wheels	68
Bergeon® Bracelet Cutter	219
Bergeon® Sprue Cutter	219
Bezel Blocks and Punch Sets	113
Bezel Mandrels	261,261
Bezel Pusher	262
Bezel Roller	262
Binding Wire-Iron	271
Black Top Bur Kits	77
Block Shelves-GRS	49
Boley Style Tweezers	311
Books	32-38
Borax® Powder	273
Boric Acid Powder	273
Bouron® Wax Tools	343
Bracelet Holder	317

Bracelet Pin Plier	317
Bracelet Shear	318
Bracelet Stretcher	232
Bracelet and Ring Sizers-Wooden	50, 170
Bracelet Gauge	165
Bracelet Holder	47
Bracelet Mandrels	50, 170
Brass Head Mallet	187
Brass Practice Plates/Rings	139
Brass Scratch Brush	56
Brightboy® Wheels, Points, Pumice & Tablet	12
Bristle Brushes-Hardwood Center	55
Bristle Brushes-Plastic Center	54
Bristle Cup Brushes	52
Brite-CR	102
Brown Shears	222
Brushes	52-58
Bufs	58-68
Bur Lube	80, 248
Burgess Vibro Engraver	146
Burnishers-Steel, Agate	42,43,260
Bur Set- Sets	70-74
Burn Out Furnaces	96
Butane Torches	305

C

Caddy Kits	299
Carat Scales	121
Carbide Burs	78
Carbide Bur Set	145
Carbide Florentine Burs	79
Carbide Inside Ring Burs	79
Carbide Rotary Bur	77
Case/Movement Holder	318
Case Closing Plier	319
Case Holder Bench Type	320
Case Knife Opener	319
Case Opener -Crab Type	319
Case Press	319
Case Wrench Rolex-Jaxa	318
Castaldo® Injection Waxes	331
Castaldo® Mold Rubber	84, 85
Casting Alloys	89
Casting Machines Vacuum- Centrifugal	94,95
Centrifugal Machine-Long Arm	95
Ceramic Ring Stand	268
Ceramic Soldering Blocks	270
Ceramic Tweezers	268, 310
Ceraton Polishers	22
Ceramation	206
Chamois Cloths	106, 226
Chamois Bufs	63
Channel Setting Set	262
Charcoal Block	271
Chasing Hammers	187
Chinese White	139
Chuck Adapters	159
Chuck Key	160
Claw Setting Jig	262
Cleaners	102
Clip-on Opticaid® Magnifiers	198
C-Master Jewelry Gauge	165
Cold Shield	272



Color Posters	128
Combination Bench Pin with Anvil	40
Combustible Gas Alarm	303
Compact Diamond Scale	123
Compact Motorized Rolling Mills	240
Complete Ultra 850 Rotary System	145
Compound Sprue Cutter	219
Cone Drum Sander	23
Connoisseurs Jewelry Cleaners	106, 107
Contour Vise Jaws-GRS	49
Cool Paste	272
Copper Tongs	271
Copper Wire	206
Cotton String Buffs	63
Counter Top Light	192
Cratex® Assortment Kits	11
Cratex® Blocks & Sticks	11
Cratex® Large Wheels	11
Cratex® Wheels & Points	10
Crimp Beads & Tubes	29
Crimped Metal Wire Brushes	54
Crocker Pattern-Graver Sharpener	181
Cross Lock Tweezers	312
Crucibles & Melting Dish	99
Crucible Tongs	92
Crucible with Handle	92
Crystal Cement	321
Crystal Remover	320
Cut-off Wheels	13
Cyber-Therm Tweezers	268
CZ Master	125

D

Dandix Paste Flux	272
Dapping Blocks- Sets	110,112
Dapping Blocks-Wood	114
Dapping Punches	111
Dazor® BenchFlex	190
Dazor® Lamps	190
Debubblizer	333
Decoze® Split Felt Laps	58
Dedeco® Miracle Gold Wheels	18
Dedeco® Rubber Flexie Polishers	19
Degree Gauges	166
Deluxe Spring Bar Remover	317
Deluxe Wax Mandrel Set	342
Deluxe Link Pin Remover	317
Deluxe Ring Sizer	169
Designer Templates	334
Devcon® Epoxy	266
Dial Thermometer	90
Dialux Polishing Compounds	224
Diamond Burs	80
Diamond Cutting Discs	13
Diamond Coated Drills	129
Diamond Display Boxes	128
Diamond Discs	130
Diamond Fly Wheels	129
Diamond Gauge	167
Diamond Parcel Papers	117
Diamond Pearl Gauge	167
Diamond Points	130
Diamond Relicas	128

Diamond Scoops	127
Diamond Scribe	125,296
Diamond Sellers	123
Diamond Sieves	116
Diamond Sorting Pads	117
Diamond Testers	296
Diamond Tweezers- Swiss	308, 312
Diamond Stone Bur Set	146
Diamond Needle Files	151
Diamond Vest	126
Diamond Washing Cups	127
Diamond Wallets	127
Digimatic Caliper	164
Digital Gauge	165
Disclosing Wax	333
Dividers with Square Legs	167
Double End Polisher	228
Double Shaft Polisher / Dust Collector	229
Double-End Vulcanite Files	344
Double-Ended Pin Vise with Collets	314
Double Ended Tracer	42
Draw Benches-Plates-Tongs	241, 242
Drill Gauges	133
Drill Press	134
Drills -Jewelers-Twist-Sets	132,133
Dual Hose	303
Dust Collector Hood and Accessories	227

E

Ear Studs	207, 208
Ear Stud Gun	207
E.C.Moore Discs	9
E.C.Muller® Gravers	176, 177
Edenta Top Star, Goldino & Ocean	19
Electer E-max-NSK	162
Electric Engraver	146
Electrocleaner	205
Electric Ring Stretcher	232
Electro-Melt Furnace	98
Electronic Foot Control-FCT	158
ELMA Ringmeter	233
Elma Watch Cleaning Machine	322
Elma Watch Servicing Unit	322
Elma Watch Winder-Box Type	322
Elma Engraving Templates, Type Sets	139
Elma Modulgrav Engraver	138
Elma Ringstar Engraver	138
Elmasonic E-series	102
Emery Ring Shells	13
Emery Sticks	13
Empty Cylinders and Tanks	301
Enameling Kiln	207
Enamels	207
End Bristle Brushes	52
End Knot Bristle Brushes	52
End Wire Mounted Brushes	52
Energizer Batteries	323, 324
Engraving Character Sets	136
Epoxy 330/220	266
Ergonomic Ring Stretcher	232
Escapement Files	151,155
Eschenbach Precision Loupes	195
Espert 500C-NSK	162
EVE Airflex Polishing Wheels	16

EVE Mounted EVEflex Polishers	16
EVE Platinum, Diamond & Pumice Wheels	17
EVE Silicone Polishers	15
EVE Silicone Rubber Points & Wheels	14
Eye Loupes	321
Expandable Abor Drum	23

F

Fan Type Diamond Gauge	167
Faro® Handpieces	161
Felt Buffs	64
Felt Wheels	58
Ferris Cowdery Profiles	331
Ferris File-A-Wax®	327
Ferris File-A-Wax® Shapes	328
Ferris Flexible Wax Sheets	328
Ferris Injection Waxes	330
Ferris Inlay Wax	330
Ferris Mold-A-Wax®	330
Ferris Red Utility Wax Sheets	333
Ferris Sprue Wax Rods	332
Ferris Wax Ring Tubes	326
Ferris Yellow Sticky Wax	330
Ferris® See-Thru Mold Frames	86
Files	148-156
File Cleaner	156
Final Touch	262
Finex Muslin Buffs-Knife Edge	61, 62
Finger Guard Safety Tape	227
Finger Guards	244
Finger/Necklace Sizer	232
Flap Wheels	13
Flashback Arrestors	301
Flask Extender & Sleeves	91
Flasks Regular, Perforated	91
Flask Tongs	92
Flexible Ruler	164
Flexshafts	158
Flexshaft Handpiece	160-161
Flexible Shaft Motors	159
Flexshaft System-Kits	158
Florentine Cylinder Burs	79
Fluorescent Lamps	191
Fume Hood	
Furnaces-Fiber/Burnouts	96

G

Garrett® Metal Detectors	295
Gasaver	303
Gaskets-High temp-Silicone	92
Gauges	164-170
Gemological Instruments	171-174
Gems 10X Triplet Loupes	194
Gem Setting Bur with Gauge	80
Gem Testers Presidium®	296
General Purpose Tweezers	310, 311
Glass Fiber Brush	56
Goblet Buffs	63
Gold Collecters	229, 338
Gold Testing Acid	294
Gold Testing Kits & Needle	294
Gold Loupes-14kt	193
Goldsmith Hammer	187
Gravers	176-182



Graver Handles-ThermoLoc	178
Graver Sharpeners	181
Griffin Bead Cords	28, 29
Grobet® Files-Swiss	148, 150
GRS® Bench Accessories	48
GRS® Magna Block- Standard	143
GRS® BurnishingTools	180
GRS® Complete Sharpening Systems	144
GRS® Glensteel Gravers	180
GRS® GraverMach®	140
GRS® GraverMax® SC	140
GRS® Gravermeister®	142
GRS® Hand Chuck	180
GRS® Heat Treated Steet Points	178
GRS® Line Gravers	179
GRS® Sharpening Fixtures	145
GRS® System3	140
GRS® Tool Organizers	181
GRS® Tungsten Carbide Gravers	178
GRS® MicroBlock	49
GRS® RingSizeCutter	222, 235
GRS® Third Hand Soldering Stations	269

H

H.Schneider® Jewelers Loupe	195
Half Round Finger Sizer	168
Hammers	184-188
Hammer Handpieces	160
Hand Remover- Plunger Type	320
Hand Stamp Sets	277
Hand Vise Plier	314
Hand Vise with Wing Nut	314
Hand Drill	43
Handheld Ring Clamp	234
Handler Polishing / Dust Collector	229
Handpieces GRS®	141, 142
Handpieces Foredom®	160
Handy® Flux	272
Hardwood Shellac Holders	265
Harris Melting Kits	304
Head & Shank Tweezers	310
Heat Resistant Gloves	100
Heating Tips	300
Heatless Wheels	21
Heavy Duty Motorized Rolling Mills	240
Heavy BrassTemplates	139
High Pressure Blaster Cabinet	91
High Speed Gravers	177, 182
High Speed Jewelers Bur, Kits	75, 76
High Speed Rotary Handpiece	145
Hi-Impact Dial Caliper	164
Hoffman® Steam Cleaner	103
HOKE Type-Jewel Torch & Adapter Kits	304
Holder with Chuck	261
Honeycomb Soldering Blocks	270
Hose Connection, Hose	300, 301
Hydro Air Wash Gun	90
HydroGem	304

I

IkFlex Elastic Bond Wheels	67
Illuminated Magnifier	194
Ionic Cleaners	103
Ingot & Graphite Molds	100

Initial Polishing Compounds	225
InLine Ring Rack	104
Inside Ring Engraver	136, 137
Inside Ring Engraving Holder	234
Inside Ring Setters Set	263
Inside Felt Ring Buffs	64
Inside Ring Holder	41, 49
Inspection Cotton Gloves	227
Inva-Cast	94
Investment Mixer	90
Investment Mixing Bowls-Rubber	90
Investment Scale	90
Investment Scoop/Spatula	90
Italian Saturn® Melter	97

J

Jade & Ruby Filters	193
Jett Sett®	265
Jewelers Burs	70-73
Jewelry Cleaners	107
Jewelry Mold Release Spray	87
Jewelry Wipes	106
Jo-Di Gauge	166
Jumbo Bur Kit	74
Jumbo Finger Sizer	168
Jumbo Steel Ring Mandrel	169
Jump Ringer System	45
JUN-AIR® Compressor	146

K

K&B Diamond Gauge	166
Kagan Ring Roller	232
Kagan Wedding Ring Sizer	232
Keiba Cutters	219
Kerr® Electro Melt	98
Kerr® Injection Waxes	332
Kerr® Mastertouch™	341
Kerr® Smoothy Flamless Finisher	342
Kerr® Ultra Waxer	341
Kerr® Graphite Crucibles	98
Kerr® Wax Injectors	82
Kirkland Ring Clamps	41
Kits with Regulator - Disposable Tanks	298
Knife Edge Felt Wheels	58
Knifemaker's ContourVise-GRS®	49
Koyo® Premium Platinum Rouge	224
Koyo® / 3M® Sanding Belts	7

L

Labeling and Bar Coding	348
Lap Joint Pliers-Germany	216
Lathe Bench	134
Lathe Millgrain	236
Leather Pads	143
Leather Strap	63
Leather Wallets	127
Lever Type Case Press	319
Leveridge Type Gauge	168
L-G "OpenAll" Case Wrench	319
L-G Master Case Opener	318
Lightweight Face Shield	244
Lindstrom® Pliers	211, 212
Lint Free Cloths for Precious Stones	106, 226
LiquaGlass®	86

Liquid Mold Rubber	86, 87
Liver of Sulpher	206
Little Torch Kits	298
Loupe Chains	195
Loupes Jewelers	195
Lowell Pattern Hand Vise	314

M

Magic Soldering Products	273
Magic Luster & Concentrates	105
Magna Deluxe Fluorescent Lamp	191
Magnesia Block	271
Magnetic Torch Stand	305
Magnetic Tool Holder	50
Magnifiers	192
Magnifying-Eye Glasses	196
Mallets-Removable Faces	188
Mandrel Tapered/Stepped	344
Mandrels-Screw, Split, Pin, Chuck	24
Margin Rollers	43, 260
Marking Plier	220, 278
Masking Tapes	92
Matt® Bracelet Template	339
Matt® Creative Setting Kit	339
Matt® Gold Collector	338
Matt® Mini Lathe with Gauge	337
Matt® Miter Box Set	336
Matt® Reamer	338
Matt® Ring Template	339
Matt® Ring Tube Sizer	336
Matt® Shaper	337
Matt® Techniques of Design	339
Matt® Trimmer	337
Matt® Wax Bars & Slices	335
Matt® Wax Gun Kit	338
Matt® Wax Ring Tubes	334
Matt® Wax Rods	338
Matt® Wax Routing Bur	336
Matt® Wax Tablets	336
Maun Type Cutter	219
Media	285-287
Megaview-Japan	196
Melters- Saturn - Kerr®	97, 98
Melting Dishes-Silica, Platinum	99
Menzerna® Rouge	225
Metal Cup Brushes	52
Micro Film	333
Microblock™ Ball Vise	143
Micrometer	168
Micro-Motors	162
Microscopes	146, 171, 173
Midget Buffs	60, 62
Millgrain Wheels-Sets	46, 263
MILLrite - Millgrain Machine	236, 264
Mini Bench Grinder/Polisher	228
MiniMat Texturing Brushes	55
Mitchells Abrasive Tapes -Cords	22
Miter Cutter Jig-France	47
Mitutoyo Digimatic Caliper	164
MKS Battery Charge Tool Set	322
MKS Case Opener V-type	318
MKS Dust Blower -Japan	321
MKS Pocket Size Case Opener	319
MKS Special Watch Vise	322



MKS Watch Case Opener	319
Moe Type Degree Gauge	166
Mold Cream	87
Mold Cutting Blades, Handles	88
Mold Frames	88
Molding Rubber	84, 85, 87
Mold Lock Formers	86
MoldMate	88
Moldmatic® ReadyMade Molds	86
Mold Release Spray	87
Motor Hanger	159
Mounted Brass Brushes	53
Mounted Felt Bobs	59
Mounted Steel Brushes	53
Mounted Wheel Bristle Brushes	53
Multi Purpose Pin Press	318
Multi-Purpose Tool Holder	181
Multi-Purpose Vise-GRS®	49
Muslin Loose Buffs	61

N

Nano Jewelry Coating	105
Neclace Mandrels	114
Needle Tip Flux Dispenser	273
Needle File Handles	156
Needle Files- Sets	149, 151
Neycraft® Centrifugal C/Machine	95
Nikon® Professional Loupe	195
Non-Asbestos Paper Rolls	92
Norton® Beartex Wheel	60
Norton® Oil	26
Norton® Shop Rolls, Cloths, Sheets..	6
Norton® Stones	25
NTG-New Traditional Gravers	179
Nylon Mallets	187
Nylon Pliers	215

O

Opticon® Fracture Sealer	266
OptiSIGHT™ -	197
OptiVISOR®	197
Outside Ring Engraver	137, 138
Outside Ring Holder	42, 234
Oval Head Hammer	188

P

Panavise	47
Parallel Pliers-Maun	220
Paramount® Felt Ply Buffs	59
Paramount® Finest Muslin Buffs	59
Paramount® Split Felt Laps	58
Paramount® Yellow T/MuslinBuffs 86/80	59
Parts Holding Baskets	104
Pastorino Sprue Cutter	219
Pearl Holding Tweezers	309
Pearl & Stone Dial Gauges	167
Pearl Drilling Vise	47
Pearl Seat Bur Set	79
Pedestal for Rolling Mills	241
Peg Clamp Holder	42, 260
Pen Platers	202
Pen Type Scratch Brushes	56
Perforated & Regular Flasks	91

Pica Blue Platinum Rouge	224
Picklers	271
Plastic Bur Stands	78
Plastic Coated Steam Tweezers	105
Plastic Finger Sizer	168
Plastic Mallets	188
Plastic Ring Stick	169
Plastic Strainer	104
Plast-O-Wax	332
Plating Baths	200-201
Plating Racks	104, 206
Plating Rectifiers, Anodes	203, 204
Platinum Rouge	224
Platinum Solders- Cadmium Free	274
Platinum Casting Machine	94
Plier Organizers	50, 220
Pliers & Cutters	217, 218
Plumb Solders- Cadmium Free	274
Pneumatic AirScribe®	161
Pneumatic Sprue Cutter	220
Pocket Gauges	165, 166
Polishing Cloths	226
Polishing Compounds	224, 225
Polishing Wheel-Set	21
Portable Flip Lamp-White Light	192
Portable Ring Shears	222, 235
Portable Worklight	50
Power Hand Ring Stretcher	232
Precious Metal Tester	295
Precision Ring Stamps	276
Precision Screwdriver Sets	258
Precision Speedy Wax Tool	343
Precision Waxer	343
Preset Regulators for Disposable Tank	300
Presidium® Gauges	168
Presidium® Engravers	137
Prong Lifter	262
Prong Lifting Pliers/Open /Closing	260
Prong Pusher	262
Pumice Wheels	17, 20
Pump Flux Dispenser	273

Q

Quick Change Gravers-HSS	178
Quartz Movement Cleaner	321
Quatro® Jet Stream-Clean Air	230
Quatro® Polisher /Dust Collector	230
Quick Fix Adesives	266
Quick-GripBar Clamp	42
Quick Mini Digital Gauge	165

R

Radial Bristle Discs	65
Rathburn Ring Stretcher	232
Rawhide Mallets	188
Rayner Emerald Filter	193
Red Sable Brushes	56, 273
Red Treated Muslin Buffs	61
Regular Pliers-5"	215
Regulator Check Valves	301
Replacement Parts- Flexshafts	159
Resin Release	87
Reversible Blade Screwdrivers	258
Rhodium Plating Baths	200, 201

Ring Bending Pliers	235
Ring Clamps	234
Ring Cutter	235
Ring Gripper	234
Ring Guards	235
Ring Holding Plier	235
Ring Holding Tweezers	311
Ring Mark A Size	235
Ring Mate	233
Ring Repair Kit	233
Ring Setter's Flanges	262
Ring Setters Clamp	233
Ring Shank Bender	233
Ring Soldering Tweezers	268
Ring Stamping Device	277
Ring Stamping Machine	278
Ring Stamps-Imported	277
Ring Stretcher with Reducer	232
Ring Bristle Brush	56
Ring Clamps	41, 143
Ring Cleaning Racks	104
Ring Setters Clamp	46
Ring Sticks Lightweight	170
Riveting Hammers	187
Rolex Case Attachment	318
Rolling Mills	238
Rotating Soldering Table	270
Rotating Bur Stand	78
Rouge Cloth, Compounds	106, 225, 226
Rubber Finger Cots	226
Rubberized Wheels	21

S

Safety Apron	244
Safety Glasses	244
Safety Goggles	244, 305
Salamander® Graphite Crucibles	99
Sambol® Jewelry Products	108
Satellite Furnaces	97
SatinCast Investments	89
Satiner Compound	226
Satin Finish Wheels, Buffs, Flap	60, 68
Saw Blades & Frames	246, 247
Scratch Brushes	52
Screw Type Link Pin Remover	317
Screwdriver Sets	320
Screwdrivers	258
Screwplates with Taps	44
Selvyt® Cloth-Impregnated	106, 226
Separating Discs	13
Setter's Tube Holder	260
Setter's Ring Clamp-USA	41
Setting Burnisher Sets	263
Shape Forming Pliers	216
Sharpening Stones	25, 26
Shears	221, 222
Sheet Repair Solders- Cadmium Free	274
Shellac Flake & Sticks	265
Shell Mandrels	13
Shofu® Gold Polishing Kits	18
Shofu® Mounted Stones & Points	18
SightServers	193
Silicone Wheels	14, 15, 17, 20



Silver Solders	274
Silversmith Hammers	184-185
Simichrome Polishing Paste	227
Single End Polisher	228
Single Spindle Polisher/Dust Collector	229
Single Stage Regulators	300
Sliding Pin Vise	314
Sliding Gauges	164
Slim-Line Pliers	214
Smith Casting Melting Torch	303
Smoothy Flamless Finisher	305
Soft Flex Beading Wire	30
Soft Polishing Compounds	225
Soft Grip Knife	87
Solder Cutting Pliers	274
Solder Flux	272
Solder Free Tweezers	310
Solder Pastes	274
Solder Pic	268
Soldering Boards	270
Soldering Tweezers	268, 312
Solitine	333
Sparex® Pickling Compound	271
Speed Brite Ionic Cleaners	103
Speedy Wax Pen	342
Spiral Hand Drill	43
Split Lapping Machine	228
Split & Beveled Felt Laps	58
Split Wood Mandrel	23
Sprial Saw Blades	248
Spring Bars	317
Spring Bars - Assorted Sets	320
Spring Grip Tweezers	311
Spring Clip Optical® Magnifiers	198
Sprue Bases & Holders	93
Sprue Cutters	219
Sprue Former-Mandrel	87
Square Chuck Pin Vise	314
St.Louis Investment Mixers	85
Stainless Steel Baskets & Trays	103
Stainless Steel Pliers	212
Stamp Sets- Imported	277
Stamping Anvil	276
Standard Flat Bands	168
Stakes	186
Starlight- Diamond Tweezers	309
Starrett® Dividers	166
Stay Bright Soldering Set	272
Steam Cleaners- Additive	103, 105
Steel Hand Vise	314
Steel Bench Block	40
Steel Bracelet Mandrels with Tang	169
Steel Ring Mandrels	169
Steel Vernier Caliper	164
Stirring Rods	98
Stone Ring Stretcher	233
Stone Setter's Cement	265
Stone Millimeter Dial Gauges	167
Stone Setting Bur Set	79
Strap Notchers	317
Superlight Pliers	212
Super Pins	143
Swiss Beading Tools	264

Swiss Bur Kits	74
Swiss Precision Files	148
Swiss Sprue Cutter	219
Swiss Victorinox Knife	47
Swivel Head Pin Vise	314

T

Tags-Strings-PVC	290
Tapered Chuck for Brushes	56
Tapered Muslin Buffs	63
Technique Handpiece	161
Teflon Grip Tweezers	309
Telesight Magnifiers	198
Tennis Bracelet Holder	260
Test Acids	294
Test Stones	294
TG-Traditional Gravers	180
The EZ Torch	306
The Swiss Torch	306
Thermic Isolator Grain	271
Tips- Little Torch	299
Titanium Diamond Tweezers	309
Tivaclean, Tivabright	105
Tix Solder	272
Tools for Filing-Hinges	42
Tool Storage & Plier Organizers	50
Torch Holder-Deluxe	305
Torch Lighter & Flint	305
Torch Mate Lighter	304
Triplets Loupes	194
Triad Hammer	188
Tricord Knotting Tool	31
Tube Cutter	47, 248
Tungsten Carbide Draw Plates	242
Tungsten Carbide Burs	80
Tweezers	118, 308
Two Hose Manifolds	301
Two Stage Regulators	300

U

Ultra Concentrate-Pink	105
Ultrasonic Cleaners	102, 107
Ultra SonicSoap-Gold	105
Umbrella Type Ring Rack	104
Uniflex Inside Ring-Cone Buffs	63
Universal Ring Stick	169
Universal Working Block	186
Unmounted Brushes-Plastic Center	54
Unmounted Texturing Brushes	55
Unmounted Wheel Bristle Brushes	53
Unmounted Wire Brushes	53
Utility Combination Anvils & Stakes	40
UV Filter	268
UV Portable Lights	192

V

Vacufilm	333
Vacuum Casting Machines	94, 95
Valtitan Files	150
Valve Assemblies	305
Vise-Mini Bench	47
Vise for Waterproof Watches	320
V-Slot Bench Pin with Clamp	42
Vulcanizers	83

W

Washout Brushes	52
Watch Batteries	324
Watchmakers Tap and Die	44
Watch Cleaning Machine	321
Watch Hand Remover- Presto	320
Watch Maker Hammers	188, 320
Watch Tissue Paper	321
Watch Winder	322
Wax-A-Sizer	344
Wax Burs	79, 342
Wax Carvers Tools Set	342
Wax Detailer , Rasps	344
Wax Heating Tray	343
Wax Kleen	336
Wax Wire Spool	333
Wax Worker	343
Wax Files	154, 156
Wax Hand Files-Flat	156
Wax Injectors	82
Western - "One Dip"	321
Western Klear -Buffing Compound	321
Western Silcon-7® Sealant	321
Wide Band Finger Sizer	168
Wire Bending Plier	221
Wire Steel Gauge	165
Wire Rounder	31
Wolf's Belt Sander	44
Wolf's Precision Wax Carvers	340
Wolf's Waxes	329
Wolf Waxes Trimmer	337
Wood Handle Pin Vise	314
Wood Handle Scribes	261
Wood Bench Pins	41
Wooden Bur Block- Boxes	78
Wood File Handles	156
Work Benches	345

X

Xuron Series Premium Quality Shears	210
-------------------------------------	-----

Y

Y2K Series Pliers & Cutters	213
Yellow Ochre	273
Yellow Sanding Discs	8
Yellow Treated Knife Edge Buffs-L/C	62
Yellow Treated Muslin Buffs	62

Z

Zeiss® Loupes	195
Zirconia Discs	8
Zodiac Signs	137



NEW # TO OLD

ITEM #	PG#	ITEM #	PG#	ITEM #	PG#	ITEM #	PG#	ITEM #	PG#	ITEM #	PG#	ITEM #	PG#	ITEM #	PG#		
21		21-1224	4	21-1454	8	21-1541	9	21-1635	4	21-1743	7	21-1818	10	21-1925	11	21-2082	13
21-1011	2	21-1231	6	21-1455	8	21-1542	9	21-1636	4	21-1744	7	21-1819	10	21-1926	11	21-2083	13
21-1012	2	21-1232	6	21-1461	8	21-1543	9	21-1637	4	21-1745	7	21-1820	10	21-1927	11	21-2084	13
21-1013	2	21-1233	6	21-1462	8	21-1544	9	21-1638	4	21-1746	7	21-1831	10	21-1931	11	21-2085	13
21-1014	2	21-1234	6	21-1463	8	21-1545	9	21-1641	4	21-1747	7	21-1832	10	21-1932	11	21-2086	13
21-1015	2	21-1235	6	21-1464	8	21-1546	9	21-1642	4	21-1748	7	21-1833	10	21-1933	11	21-2091	13
21-1016	2	21-1236	6	21-1465	8	21-1547	9	21-1643	4	21-1749	7	21-1834	10	21-1934	11	21-2092	13
21-1017	2	21-1237	6	21-1466	8	21-1548	9	21-1644	4	21-1751	7	21-1835	10	21-1935	11	21-2095	13
21-1018	2	21-1238	6	21-1467	8	21-1551	9	21-1645	4	21-1752	7	21-1836	10	21-1936	11	21-2096	13
21-1019	2	21-1241	6	21-1468	8	21-1552	9	21-1646	4	21-1753	7	21-1837	10	21-1937	11	21-2097	13
21-1020	2	21-1242	6	21-1469	8	21-1553	9	21-1647	4	21-1755	7	21-1838	10	21-1938	11	21-2098	13
21-1021	2	21-1243	6	21-1470	8	21-1554	9	21-1648	4	21-1756	7	21-1841	10	21-1943	11	21-2101	14
21-1031	2	21-1244	6	21-1471	8	21-1555	9	21-1651	4	21-1757	7	21-1842	10	21-1944	11	21-2102	14
21-1032	2	21-1245	6	21-1472	8	21-1556	9	21-1652	4	21-1758	7	21-1843	10	21-1945	11	21-2103	14
21-1033	2	21-1301	2	21-1481	8	21-1560	3	21-1653	4	21-1761	7	21-1844	10	21-1946	11	21-2104	14
21-1034	2	21-1302	2	21-1482	8	21-1561	3	21-1654	4	21-1762	7	21-1845	10	21-1947	11	21-2105	14
21-1035	2	21-1303	2	21-1483	8	21-1562	3	21-1661	5	21-1763	7	21-1846	10	21-1948	11	21-2106	14
21-1041	2	21-1311	2	21-1484	8	21-1563	3	21-1662	5	21-1764	7	21-1847	10	21-1949	11	21-2107	14
21-1042	2	21-1312	2	21-1485	8	21-1564	3	21-1663	5	21-1765	7	21-1848	10	21-1950	11	21-2108	14
21-1043	2	21-1313	2	21-1486	8	21-1565	3	21-1664	5	21-1771	10	21-1849	10	21-1951	11	21-2109	14
21-1051	2	21-1321	3	21-1501	9	21-1566	3	21-1665	5	21-1772	10	21-1850	10	21-1952	11	21-2110	14
21-1052	2	21-1322	3	21-1502	9	21-1567	3	21-1666	5	21-1773	10	21-1851	10	21-1953	11	21-2111	14
21-1053	2	21-1323	3	21-1503	9	21-1568	3	21-1667	5	21-1774	10	21-1852	10	21-1954	11	21-2112	14
21-1054	2	21-1324	3	21-1504	9	21-1569	3	21-1668	5	21-1775	10	21-1853	10	21-1955	11	21-2113	14
21-1055	2	21-1341	6	21-1505	9	21-1570	3	21-1669	5	21-1776	10	21-1854	10	21-1956	11	21-2114	14
21-1056	2	21-1342	6	21-1506	9	21-1571	3	21-1670	5	21-1777	10	21-1855	10	21-1957	11	21-2115	14
21-1081	6	21-1343	6	21-1507	9	21-1572	3	21-1671	5	21-1778	10	21-1856	10	21-1958	11	21-2116	14
21-1082	6	21-1404	8	21-1508	9	21-1573	3	21-1672	5	21-1779	10	21-1873	10	21-1959	11	21-2121	14
21-1083	6	21-1405	8	21-1509	9	21-1574	3	21-1673	5	21-1780	10	21-1875	10	21-1960	11	21-2122	14
21-1091	6	21-1406	8	21-1510	9	21-1575	3	21-1674	5	21-1781	10	21-1878	10	21-1961	11	21-2123	14
21-1092	6	21-1407	8	21-1511	9	21-1576	3	21-1681	5	21-1782	10	21-1881	11	21-1962	11	21-2124	14
21-1093	6	21-1408	8	21-1512	9	21-1577	3	21-1682	5	21-1783	10	21-1882	11	21-2011	12	21-2125	14
21-1094	6	21-1409	8	21-1513	9	21-1578	3	21-1683	5	21-1784	10	21-1883	11	21-2012	12	21-2126	14
21-1095	6	21-1411	8	21-1514	9	21-1581	3	21-1684	5	21-1785	10	21-1884	11	21-2016	12	21-2127	14
21-1096	6	21-1412	8	21-1515	9	21-1582	3	21-1685	5	21-1786	10	21-1891	11	21-2017	12	21-2128	14
21-1097	6	21-1413	8	21-1516	9	21-1583	3	21-1686	5	21-1787	10	21-1892	11	21-2018	12	21-2129	14
21-1101	6	21-1414	8	21-1517	9	21-1584	3	21-1687	5	21-1788	10	21-1893	11	21-2019	12	21-2130	14
21-1102	6	21-1415	8	21-1518	9	21-1601	22	21-1688	5	21-1789	10	21-1894	11	21-2021	12	21-2131	14
21-1103	6	21-1416	8	21-1519	9	21-1602	22	21-1689	5	21-1790	10	21-1895	11	21-2022	12	21-2132	14
21-1104	6	21-1417	8	21-1520	9	21-1603	22	21-1690	5	21-1791	10	21-1896	11	21-2031	12	21-2133	14
21-1105	6	21-1418	8	21-1521	9	21-1604	22	21-1701	5	21-1792	10	21-1897	11	21-2032	12	21-2134	14
21-1201	3	21-1419	8	21-1522	9	21-1605	22	21-1702	5	21-1793	10	21-1898	11	21-2033	12	21-2135	14
21-1202	3	21-1420	8	21-1523	9	21-1606	22	21-1703	5	21-1794	10	21-1899	11	21-2034	12	21-2136	14
21-1203	3	21-1421	8	21-1524	9	21-1607	22	21-1704	5	21-1801	10	21-1900	11	21-2041	12	21-2141	14
21-1204	3	21-1422	8	21-1525	9	21-1608	22	21-1705	5	21-1802	10	21-1901	11	21-2042	12	21-2142	14
21-1206	3	21-1431	8	21-1526	9	21-1611	22	21-1706	5	21-1803	10	21-1902	11	21-2043	12	21-2143	14
21-1207	3	21-1432	8	21-1527	9	21-1612	22	21-1707	5	21-1804	10	21-1903	11	21-2044	12	21-2144	14
21-1208	3	21-1433	8	21-1528	9	21-1613	22	21-1708	5	21-1805	10	21-1904	11	21-2051	12	21-2145	14
21-1209	3	21-1434	8	21-1529	9	21-1614	22	21-1709	5	21-1806	10	21-1905	11	21-2052	12	21-2146	14
21-1211	4	21-1435	8	21-1530	9	21-1617	22	21-1710	5	21-1807	10	21-1906	11	21-2053	12	21-2147	14
21-1212	4	21-1436	8	21-1531	9	21-1618	22	21-1711	5	21-1808	10	21-1907	11	21-2061	12	21-2148	14
21-1213	4	21-1437	8	21-1532	9	21-1619	22	21-1712	5	21-1809	10	21-1908	11	21-2071	13	21-2149	14
21-1214	4	21-1438	8	21-1533	9	21-1620	22	21-1718	5	21-1810	10	21-1909	11	21-2072	13	21-2150	14
21-1216	4	21-1439	8	21-1534	9	21-1621	22	21-1720	5	21-1811	10	21-1910	11	21-2073	13	21-2151	14
21-1217	4	21-1440	8	21-1535	9	21-1622	22	21-1721	5	21-1812	10	21-1911	11	21-2074	13	21-2152	14
21-1218	4	21-1441	8	21-1536	9	21-1623	22	21-1722	5	21-1813	10	21-1912	11	21-2076	13	21-2153	14
21-1219	4	21-1442	8	21-1537	9	21-1631	4	21-1723	5	21-1814	10	21-1913	11	21-2077	13	21-2154	14
21-1221	4	21-1451	8	21-1538	9	21-1632	4	21-1724	5	21-1815	10	21-1914	11	21-2078	13	21-2155	14
21-1222	4	21-1452	8	21-1539	9	21-1633	4	21-1741	7	21-1816	10	21-1921	11	21-2079	13	21-2156	14
21-1223	4	21-1453	8	21-1540	9	21-1634	4	21-1742	7	21-1817	10	21-1922	11	21-2081	13	21-2161	15

NUMERICAL INDEX



ITEM #	PG#	ITEM #	PG#	ITEM #	PG#	ITEM #	PG#	ITEM #	PG#	ITEM #	PG#	ITEM #	PG#	ITEM #	PG#
21-2162	15	21-2243	16	21-2374	18	21-2504	20	21-2584	20	21-2711	24	21-2861	25	22-107-06	28
21-2163	15	21-2244	16	21-2375	18	21-2505	20	21-2591	20	21-2712	24	21-2862	25	22-107-08	28
21-2164	15	21-2245	16	21-2376	18	21-2506	20	21-2592	20	21-2714	24	21-2863	25	22-108-02	28
21-2165	15	21-2246	16	21-2377	18	21-2507	20	21-2596	20	21-2716	24	21-2864	25	22-108-03	28
21-2166	15	21-2247	16	21-2378	18	21-2508	20	21-2597	20	21-2717	24	21-2866	25	22-108-04	28
21-2167	15	21-2248	16	21-2379	18	21-2509	20	21-2601	21	21-2718	24	21-2867	25	22-108-06	28
21-2168	15	21-2249	16	21-2380	18	21-2510	20	21-2602	21	21-2719	24	21-2868	25	22-108-08	28
21-2171	15	21-2250	16	21-2381	18	21-2511	20	21-2603	21	21-2721	24	21-2871	25	22-109-02	28
21-2172	15	21-2251	16	21-2382	18	21-2512	20	21-2604	21	21-2722	24	21-2874	25	22-109-03	28
21-2173	15	21-2252	16	21-2386	18	21-2513	20	21-2605	21	21-2725	24	21-2877	25	22-109-04	28
21-2174	15	21-2253	16	21-2387	18	21-2514	20	21-2606	21	21-2726	24	21-2878	25	22-109-06	28
21-2181	15	21-2254	16	21-2388	18	21-2515	20	21-2607	21	21-2727	23	21-2891	26	22-109-08	28
21-2182	15	21-2255	16	21-2391	18	21-2516	20	21-2608	21	21-2728	23	21-2892	26	22-110-04	28
21-2183	15	21-2256	16	21-2401	19	21-2517	20	21-2609	21	21-2731	24	22		22-110-06	28
21-2184	15	21-2257	16	21-2402	19	21-2518	20	21-2610	21	21-2732	23	22-0010	31	22-110-08	28
21-2185	15	21-2258	16	21-2403	19	21-2519	20	21-2611	21	21-2733	23	22-0011	31	22-111-04	28
21-2186	15	21-2259	16	21-2404	19	21-2520	20	21-2612	21	21-2741	23	22-0014	31	22-111-06	28
21-2187	15	21-2262	17	21-2405	19	21-2521	20	21-2613	21	21-2742	23	22-0016	31	22-111-08	28
21-2188	15	21-2263	17	21-2406	19	21-2522	20	21-2614	21	21-2751	23	22-0019	31	22-112-02	28
21-2189	15	21-2265	17	21-2407	19	21-2523	20	21-2615	21	21-2752	23	22-0021	31	22-112-03	28
21-2190	15	21-2266	17	21-2408	19	21-2524	20	21-2621	21	21-2754	23	22-0024	31	22-112-04	28
21-2191	15	21-2268	17	21-2409	19	21-2525	20	21-2622	21	21-2757	23	22-0031	31	22-112-06	28
21-2192	15	21-2269	17	21-2410	19	21-2526	20	21-2623	21	21-2761	23	22-0032	31	22-112-08	28
21-2193	15	21-2272	17	21-2411	19	21-2527	20	21-2624	21	21-2762	23	22-0051	31	22-113-02	28
21-2194	15	21-2273	17	21-2412	19	21-2528	20	21-2625	21	21-2764	23	22-0052	31	22-113-03	28
21-2201	15	21-2275	17	21-2421	18	21-2531	21	21-2626	21	21-2771	23	22-0071	31	22-113-04	28
21-2202	15	21-2276	17	21-2422	18	21-2532	21	21-2627	21	21-2772	23	22-0072	31	22-113-06	28
21-2203	15	21-2278	17	21-2423	18	21-2533	21	21-2628	21	21-2775	23	22-0095	28	22-113-08	28
21-2204	15	21-2279	17	21-2441	19	21-2534	21	21-2629	21	21-2776	23	22-101-00	28	22-114-02	28
21-2205	15	21-2281	17	21-2442	19	21-2535	21	21-2630	21	21-2801	25	22-101-01	28	22-114-03	28
21-2206	15	21-2282	17	21-2443	19	21-2536	21	21-2631	21	21-2802	25	22-101-02	28	22-114-04	28
21-2207	15	21-2291	17	21-2444	19	21-2537	21	21-2632	21	21-2807	25	22-101-03	28	22-114-06	28
21-2211	16	21-2292	17	21-2445	19	21-2538	21	21-2633	21	21-2808	25	22-101-04	28	22-114-08	28
21-2212	16	21-2293	17	21-2446	19	21-2539	21	21-2634	21	21-2809	25	22-101-06	28	22-115-02	28
21-2213	16	21-2294	17	21-2447	19	21-2540	21	21-2635	21	21-2810	25	22-101-08	28	22-115-03	28
21-2214	16	21-2301	17	21-2448	19	21-2541	21	21-2641	13	21-2811	25	22-102-02	28	22-115-04	28
21-2215	16	21-2302	17	21-2451	19	21-2542	21	21-2642	13	21-2812	25	22-102-03	28	22-115-06	28
21-2216	16	21-2303	17	21-2452	19	21-2546	21	21-2651	13	21-2815	25	22-102-04	28	22-115-08	28
21-2217	16	21-2304	17	21-2461	19	21-2547	21	21-2652	13	21-2816	25	22-102-06	28	22-116-02	28
21-2218	16	21-2305	17	21-2462	19	21-2548	21	21-2656	13	21-2821	26	22-102-08	28	22-116-03	28
21-2219	16	21-2306	17	21-2463	19	21-2551	21	21-2657	13	21-2822	26	22-103-02	28	22-116-04	28
21-2221	16	21-2307	17	21-2464	19	21-2552	21	21-2658	13	21-2823	26	22-103-03	28	22-116-06	28
21-2222	16	21-2308	17	21-2465	19	21-2553	21	21-2661	13	21-2824	26	22-103-04	28	22-116-08	28
21-2223	16	21-2309	17	21-2466	19	21-2554	21	21-2662	13	21-2825	26	22-103-06	28	22-117-02	28
21-2224	16	21-2310	17	21-2467	19	21-2555	21	21-2671	22	21-2826	26	22-103-08	28	22-117-03	28
21-2225	16	21-2351	18	21-2468	19	21-2556	21	21-2672	22	21-2831	26	22-104-02	28	22-117-04	28
21-2226	16	21-2352	18	21-2469	19	21-2557	21	21-2673	22	21-2832	26	22-104-03	28	22-117-06	28
21-2227	16	21-2353	18	21-2471	19	21-2558	21	21-2674	22	21-2835	26	22-104-04	28	22-117-08	28
21-2228	16	21-2354	18	21-2472	19	21-2559	21	21-2675	22	21-2836	26	22-104-06	28	22-118-02	28
21-2229	16	21-2355	18	21-2473	19	21-2561	20	21-2676	22	21-2837	26	22-104-08	28	22-118-03	28
21-2230	16	21-2356	18	21-2481	19	21-2562	20	21-2677	22	21-2838	26	22-105-03	28	22-118-04	28
21-2231	16	21-2357	18	21-2483	19	21-2563	20	21-2678	22	21-2839	26	22-105-04	28	22-118-06	28
21-2232	16	21-2358	18	21-2485	19	21-2564	20	21-2679	22	21-2841	26	22-105-06	28	22-118-08	28
21-2236	16	21-2359	18	21-2487	19	21-2571	20	21-2680	22	21-2842	26	22-105-08	28	22-119-02	28
21-2237	16	21-2360	18	21-2491	19	21-2572	20	21-2685	21	21-2851	25	22-106-02	28	22-119-03	28
21-2238	16	21-2361	18	21-2492	19	21-2573	20	21-2701	24	21-2852	25	22-106-03	28	22-119-04	28
21-2239	16	21-2362	18	21-2493	19	21-2574	20	21-2702	24	21-2853	25	22-106-04	28	22-119-06	28
21-2240	16	21-2371	18	21-2501	20	21-2581	20	21-2705	24	21-2854	25	22-106-06	28	22-119-08	28
21-2241	16	21-2372	18	21-2502	20	21-2582	20	21-2706	24	21-2858	25	22-106-08	28	22-120-02	28
21-2242	16	21-2373	18	21-2503	20	21-2583	20	21-2709	24	21-2859	25	22-107-04	28	22-120-03	28



NEW # TO OLD

ITEM #	PG#	ITEM #	PG#	ITEM #	PG#	ITEM #	PG#	ITEM #	PG#	ITEM #	PG#	ITEM #	PG#	ITEM #	PG#		
22-143-02	28	22-174-07	29	22-195-03	31	22-220-01	30	23-1118	43	23-1311	48	24-1088	56	24-1221	53	25-1032	58
22-143-04	28	22-174-08	29	22-200-01	30	22-220-02	30	23-1121	43	23-1312	48	24-1089	56	24-1222	53	25-1034	58
22-143-10	28	22-175-05	29	22-200-02	30	22-220-03	30	23-1122	43	23-1313	48	24-1090	56	24-1223	53	25-1035	58
22-144-02	28	22-175-06	29	22-200-04	30	22-220-04	30	23-1131	43	23-1314	48	24-1101	52	24-1224	53	25-1041	58
22-144-04	28	22-175-07	29	22-200-05	30	22-220-05	30	23-1132	43	23-1317	48	24-1102	52	24-1225	53	25-1042	58
22-144-06	28	22-175-08	29	22-200-06	30	22-220-06	30	23-1133	43	23-1318	48	24-1103	52	24-1226	53	25-1044	58
22-144-08	28	22-176-05	29	22-201-01	30	22-221-01	30	23-1141	43	23-1319	48	24-1104	52	24-1227	53	25-1047	58
22-144-10	28	22-176-06	29	22-201-02	30	22-221-02	30	23-1142	43	23-1320	48	24-1107	52	24-1228	53	25-1051	58
22-145-04	28	22-176-07	29	22-201-03	30	22-221-03	30	23-1151	44	23-1321	48	24-1108	52	24-1231	53	25-1052	58
22-145-06	28	22-176-08	29	22-201-04	30	22-221-04	30	23-1152	44	23-1322	48	24-1111	53	24-1232	53	25-1053	58
22-145-08	28	22-177-05	29	22-201-05	30	22-221-05	30	23-1161	44	23-1323	48	24-1112	53	24-1233	53	25-1061	58
22-145-10	28	22-177-06	29	22-201-06	30	22-221-06	30	23-1162	44	23-1324	48	24-1113	53	24-1234	53	25-1062	58
22-146-02	28	22-177-07	29	22-202-01	30	23		23-1163	44	23-1325	48	24-1114	53	24-1237	53	25-1063	58
22-146-04	28	22-177-08	29	22-202-02	30	23-1011	40	23-1166	44	23-1326	48	24-1115	53	24-1238	53	25-1064	58
22-146-06	28	22-178-05	29	22-202-03	30	23-1012	40	23-1211	45	23-1327	48	24-1116	53	24-1239	53	25-1065	58
22-146-08	28	22-178-06	29	22-202-04	30	23-1015	40	23-1212	45	23-1328	48	24-1117	53	24-1240	53	25-1071	58
22-146-10	28	22-178-07	29	22-202-05	30	23-1021	40	23-1213	45	23-1329	48	24-1118	53	24-1241	54	25-1072	58
22-147-02	28	22-178-08	29	22-202-06	30	23-1022	40	23-1214	45	23-1331	49	24-1121	53	24-1242	54	25-1073	58
22-147-04	28	22-179-05	29	22-203-01	30	23-1023	40	23-1215	45	23-1332	49	24-1122	53	24-1311	54	25-1074	58
22-147-06	28	22-179-06	29	22-203-02	30	23-1025	40	23-1216	45	23-1333	48	24-1123	53	24-1312	54	25-1075	58
22-147-08	28	22-179-07	29	22-203-03	30	23-1027	40	23-1217	45	23-1334	48	24-1124	53	24-1313	54	25-1076	58
22-147-10	28	22-179-08	29	22-203-04	30	23-1028	40	23-1221	45	23-1335	48	24-1125	53	24-1316	54	25-1077	58
22-148-02	28	22-180-05	29	22-203-05	30	23-1031	40	23-1222	45	23-1341	49	24-1126	53	24-1317	54	25-1078	58
22-148-04	28	22-180-06	29	22-203-06	30	23-1032	41	23-1223	45	23-1342	49	24-1127	53	24-1318	54	25-1079	58
22-148-06	28	22-180-07	29	22-204-01	30	23-1033	41	23-1224	45	23-1343	49	24-1128	53	24-1331	54	25-1080	58
22-148-08	28	22-180-08	29	22-204-02	30	23-1034	41	23-1225	45	23-1344	49	24-1141	54	24-1332	54	25-1081	58
22-148-10	28	22-181-05	29	22-204-03	30	23-1035	40	23-1231	46	23-1351	49	24-1142	54	24-1333	54	25-1082	58
22-149-02	28	22-181-06	29	22-204-04	30	23-1036	40	23-1232	46	23-1352	49	24-1143	54	24-1336	54	25-1091	60
22-149-04	28	22-181-07	29	22-204-05	30	23-1037	41	23-1233	46	23-1353	49	24-1146	54	24-1337	54	25-1092	60
22-149-06	28	22-181-08	29	22-204-06	30	23-1038	41	23-1234	46	23-1361	49	24-1147	54	24-1338	54	25-1093	60
22-149-08	28	22-182-01	29	22-205-01	30	23-1041	41	23-1235	46	23-1362	49	24-1151	55	24-1412	55	25-1096	60
22-149-10	28	22-182-02	29	22-205-02	30	23-1042	41	23-1236	46	24		24-1152	55	24-1413	55	25-1097	60
22-150-02	28	22-182-03	29	22-205-03	30	23-1045	41	23-1237	46	24-1011	52	24-1153	55	24-1414	55	25-1098	60
22-150-04	28	22-182-04	29	22-205-04	30	23-1046	41	23-1238	46	24-1014	52	24-1154	55	24-1415	55	25-1101	58
22-150-06	28	22-182-05	29	22-205-05	30	23-1047	41	23-1239	46	24-1015	52	24-1155	55	24-1422	55	25-1102	58
22-150-08	28	22-182-06	29	22-205-06	30	23-1048	41	23-1240	46	24-1017	52	24-1156	55	24-1423	55	25-1103	58
22-153-01	29	22-182-07	29	22-206-01	30	23-1051	41	23-1241	46	24-1018	52	24-1161	55	24-1424	55	25-1104	58
22-153-02	29	22-182-08	29	22-206-02	30	23-1052	41	23-1242	46	24-1021	52	24-1162	55	24-1432	55	25-1105	58
22-153-03	29	22-185-01	29	22-206-03	30	23-1053	41	23-1243	46	24-1022	52	24-1173	56	24-1433	55	25-1106	58
22-153-04	29	22-185-02	29	22-206-04	30	23-1055	42	23-1244	46	24-1023	52	24-1174	57	24-1434	55	25-1107	58
22-153-05	29	22-185-03	29	22-206-05	30	23-1057	42	23-1245	46	24-1031	56	24-1175	58	24-1435	55	25-1108	58
22-153-06	29	22-185-04	29	22-206-06	30	23-1058	42	23-1251	46	24-1034	56	24-1181	55	24-1451	54	25-1109	58
22-171-01	29	22-185-05	29	22-207-01	30	23-1059	42	23-1252	46	24-1036	56	24-1182	55	24-1452	54	25-1110	58
22-171-02	29	22-186-01	29	22-207-02	30	23-1061	47	23-1255	46	24-1038	56	24-1183	55	24-1453	54	25-1111	58
22-171-03	29	22-186-02	29	22-207-03	30	23-1062	42	23-1261	46	24-1041	56	24-1186	55	24-1454	54	25-1112	58
22-171-04	29	22-186-03	29	22-207-04	30	23-1063	47	23-1262	46	24-1051	56	24-1191	55	24-1455	54	25-1117	59
22-171-05	29	22-186-04	29	22-207-05	30	23-1064	47	23-1263	46	24-1052	56	24-1201	52	24-1456	54	25-1118	59
22-171-06	29	22-186-05	29	22-207-06	30	23-1065	47	23-1264	46	24-1053	56	24-1202	52	24-1461	54	25-1119	59
22-171-07	29	22-190-01	29	22-208-01	30	23-1071	42	23-1271	233	24-1054	56	24-1203	52	24-1462	54	25-1131	59
22-171-08	29	22-190-02	29	22-208-02	30	23-1072	42	23-1272	233	24-1061	56	24-1204	52	24-1463	54	25-1132	59
22-172-05	29	22-190-03	29	22-208-03	30	23-1073	42	23-1273	233	24-1062	56	24-1207	52	24-1464	54	25-1133	59
22-172-06	29	22-191-01	29	22-208-04	30	23-1074	42	23-1281	47	24-1063	56	24-1208	52	24-1465	54	25-1134	59
22-172-07	29	22-191-02	29	22-208-05	30	23-1075	42	23-1282	47	24-1064	56	24-1211	53	24-1466	54	25-1135	59
22-172-08	29	22-191-03	29	22-208-06	30	23-1076	42	23-1284	47	24-1081	56	24-1212	53	25		25-1136	59
22-173-05	29	22-192-01	29	22-209-01	30	23-1083	42	23-1286	50	24-1082	56	24-1213	53	25-1011	58	25-1141	59
22-173-06	29	22-192-02	29	22-209-02	30	23-1111	43	23-1287	50	24-1083	56	24-1214	53	25-1014	58	25-1142	59
22-173-07	29	22-193-01	29	22-209-03	30	23-1112	43	23-1291	47	24-1084	56	24-1215	53	25-1015	58	25-1143	59
22-173-08	29	22-193-02	29	22-209-04	30	23-1115	43	23-1292	47	24-1085	56	24-1216	53	25-1023	58	25-1213	59
22-174-05	29	22-195-01	31	22-209-05	30	23-1116	43	23-1296	47	24-1086	56	24-1217	53	25-1029	58	25-1214	59
22-174-06	29	22-195-02	31	22-209-06	30	23-1117	43	23-1297	47	24-1087	56	24-1218	53	25-1031	58	25-1215	59

NEW # TO OLD



ITEM #	PG#	ITEM #	PG#	ITEM #	PG#	ITEM #	PG#	ITEM #	PG#	ITEM #	PG#	ITEM #	PG#	ITEM #	PG#		
25-1216	59	25-1393	63	25-1604	62	25-1837	63	25-1964	66	26-1026	70	26-1159	70	26-1333	71	26-1523	71
25-1218	59	25-1411	60	25-1611	60	25-1838	63	25-1965	66	26-1027	70	26-1165	70	26-1335	71	26-1525	71
25-1221	59	25-1412	60	25-1612	60	25-1840	64	25-1966	66	26-1028	70	26-1170	70	26-1337	71	26-1527	71
25-1222	59	25-1413	60	25-1613	60	25-1841	64	25-1971	67	26-1029	70	26-1180	70	26-1340	71	26-1529	71
25-1223	59	25-1414	60	25-1614	60	25-1842	64	25-1972	67	26-1030	70	26-1182	70	26-1342	71	26-1530	71
25-1226	59	25-1415	60	25-1615	60	25-1845	64	25-1973	67	26-1031	70	26-1208	70	26-1345	71	26-1531	71
25-1228	59	25-1416	60	25-1621	60	25-1846	64	25-1977	67	26-1033	70	26-1209	70	26-1347	71	26-1533	71
25-1231	59	25-1421	60	25-1622	60	25-1847	64	25-1978	67	26-1035	70	26-1210	70	26-1350	71	26-1535	71
25-1232	59	25-1422	60	25-1623	60	25-1848	64	25-1979	67	26-1037	70	26-1211	70	26-1360	71	26-1537	71
25-1233	59	25-1423	60	25-1712	65	25-1861	64	25-1981	67	26-1040	70	26-1212	70	26-1370	71	26-1540	71
25-1236	59	25-1431	60	25-1713	65	25-1862	64	25-1982	67	26-1042	70	26-1213	70	26-1380	71	26-1542	71
25-1237	59	25-1432	60	25-1714	65	25-1863	64	25-1984	67	26-1045	70	26-1214	70	26-1409	71	26-1545	71
25-1238	59	25-1433	60	25-1715	65	25-1864	64	25-1986	67	26-1047	70	26-1215	70	26-1410	71	26-1547	71
25-1251	61	25-1437	60	25-1716	65	25-1865	64	25-1987	67	26-1050	70	26-1216	70	26-1411	71	26-1550	71
25-1252	61	25-1438	60	25-1717	65	25-1871	64	25-1988	67	26-1055	70	26-1217	70	26-1412	71	26-1607	71
25-1253	61	25-1439	60	25-1721	65	25-1872	64	25-1991	67	26-1060	70	26-1218	70	26-1413	71	26-1608	71
25-1254	61	25-1451	68	25-1723	65	25-1873	64	25-1992	67	26-1065	70	26-1219	70	26-1414	71	26-1609	71
25-1255	61	25-1452	68	25-1724	65	25-1874	64	25-1993	67	26-1070	70	26-1220	70	26-1415	71	26-1610	71
25-1256	61	25-1453	68	25-1725	65	25-1875	64	25-1996	67	26-1075	70	26-1221	70	26-1416	71	26-1612	71
25-1261	61	25-1461	68	25-1726	65	25-1881	64	25-1997	67	26-1080	70	26-1222	70	26-1417	71	26-1614	71
25-1262	61	25-1462	68	25-1727	65	25-1882	64	25-2011	67	26-1085	70	26-1223	70	26-1418	71	26-1616	71
25-1263	61	25-1463	68	25-1731	65	25-1885	64	25-2012	67	26-1090	70	26-1225	70	26-1419	71	26-1618	71
25-1264	61	25-1464	68	25-1732	65	25-1904	66	25-2013	67	26-1095	70	26-1227	70	26-1420	71	26-1621	71
25-1265	61	25-1465	68	25-1733	65	25-1911	66	25-2016	67	26-1100	70	26-1229	70	26-1421	71	26-1623	71
25-1266	61	25-1466	68	25-1734	65	25-1912	66	25-2017	67	26-1105	70	26-1230	70	26-1422	71	26-1625	71
25-1271	61	25-1474	66	25-1743	65	25-1913	66	25-2018	67	26-1106	70	26-1235	70	26-1423	71	26-1627	71
25-1272	61	25-1504	62	25-1744	65	25-1914	66	25-2111	63	26-1107	70	26-1240	70	26-1424	71	26-1706	71
25-1273	61	25-1508	62	25-1745	65	25-1915	66	25-2115	63	26-1108	70	26-1245	70	26-1425	71	26-1707	71
25-1274	61	25-1509	62	25-1746	65	25-1916	66	25-2116	63	26-1109	70	26-1250	70	26-1427	71	26-1708	71
25-1278	61	25-1514	62	25-1747	65	25-1917	66	25-2121	66	26-1110	70	26-1255	70	26-1429	71	26-1709	71
25-1279	61	25-1515	62	25-1748	65	25-1918	66	25-2122	66	26-1111	70	26-1260	70	26-1430	71	26-1710	71
25-1280	61	25-1518	62	25-1749	65	25-1919	66	25-2123	66	26-1112	70	26-1265	70	26-1431	71	26-1711	71
25-1281	61	25-1521	62	25-1751	65	25-1920	66	25-2125	66	26-1113	70	26-1270	70	26-1433	71	26-1712	71
25-1282	61	25-1524	62	25-1752	65	25-1921	66	25-2126	66	26-1114	70	26-1275	70	26-1435	71	26-1713	71
25-1283	61	25-1526	62	25-1753	65	25-1931	66	25-2127	66	26-1115	70	26-1280	70	26-1437	71	26-1714	71
25-1284	61	25-1531	62	25-1754	65	25-1932	66	25-2128	66	26-1116	70	26-1285	70	26-1440	71	26-1715	71
25-1285	61	25-1534	62	25-1755	65	25-1933	66	26	26-1117	70	26-1290	70	26-1442	71	26-1716	71	
25-1286	61	25-1538	62	25-1756	65	25-1934	66	26-1003	70	26-1118	70	26-1295	70	26-1445	71	26-1718	71
25-1287	61	25-1539	62	25-1757	65	25-1935	66	26-1004	70	26-1119	70	26-1300	70	26-1447	71	26-1721	71
25-1288	61	25-1544	62	25-1761	65	25-1936	66	26-1005	70	26-1120	70	26-1308	71	26-1450	71	26-1723	71
25-1289	61	25-1545	62	25-1762	65	25-1937	66	26-1006	70	26-1121	70	26-1309	71	26-1460	71	26-1725	71
25-1290	61	25-1548	62	25-1763	65	25-1938	66	26-1007	70	26-1122	70	26-1310	71	26-1470	71	26-1727	71
25-1291	61	25-1550	62	25-1764	65	25-1942	66	26-1008	70	26-1123	70	26-1312	71	26-1480	71	26-1729	71
25-1292	61	25-1551	62	25-1766	65	25-1943	66	26-1009	70	26-1124	70	26-1313	71	26-1490	71	26-1805	72
25-1293	61	25-1552	62	25-1767	65	25-1944	66	26-1010	70	26-1125	70	26-1314	71	26-1500	71	26-1806	72
25-1294	61	25-1554	62	25-1771	65	25-1945	66	26-1011	70	26-1126	70	26-1315	71	26-1508	71	26-1807	72
25-1295	61	25-1556	62	25-1772	65	25-1946	66	26-1012	70	26-1127	70	26-1316	71	26-1509	71	26-1808	72
25-1296	61	25-1561	62	25-1773	66	25-1947	66	26-1013	70	26-1128	70	26-1317	71	26-1510	71	26-1809	72
25-1297	61	25-1564	62	25-1811	63	25-1948	66	26-1014	70	26-1129	70	26-1318	71	26-1511	71	26-1810	72
25-1381	62	25-1569	62	25-1812	63	25-1949	66	26-1015	70	26-1130	70	26-1319	71	26-1512	71	26-1811	72
25-1382	62	25-1573	62	25-1813	63	25-1950	66	26-1016	70	26-1131	70	26-1320	71	26-1513	71	26-1812	72
25-1383	62	25-1579	62	25-1821	63	25-1951	66	26-1017	70	26-1133	70	26-1321	71	26-1514	71	26-1813	72
25-1384	62	25-1581	62	25-1822	63	25-1952	66	26-1018	70	26-1135	70	26-1322	71	26-1515	71	26-1814	72
25-1385	62	25-1584	62	25-1823	63	25-1953	66	26-1019	70	26-1137	70	26-1323	71	26-1516	71	26-1815	72
25-1386	62	25-1589	62	25-1825	63	25-1954	66	26-1020	70	26-1140	70	26-1324	71	26-1517	71	26-1816	72
25-1387	62	25-1595	62	25-1826	63	25-1955	66	26-1021	70	26-1142	70	26-1325	71	26-1518	71	26-1817	72
25-1388	62	25-1597	62	25-1827	63	25-1956	66	26-1022	70	26-1145	70	26-1327	71	26-1519	71	26-1818	72
25-1389	62	25-1601	62	25-1831	63	25-1961	66	26-1023	70	26-1147	70	26-1329	71	26-1520	71	26-1819	72
25-1391	63	25-1602	62	25-1832	63	25-1962	66	26-1024	70	26-1150	70	26-1330	71	26-1521	71	26-1820	72
25-1392	63	25-1603	62	25-1836	63	25-1963	66	26-1025	70	26-1153	70	26-1331	71	26-1522	71	26-1821	72



NEW # TO OLD

ITEM #	PG#	ITEM #	PG#	ITEM #	PG#	ITEM #	PG#	ITEM #	PG#	ITEM #	PG#	ITEM #	PG#	ITEM #	PG#		
26-1822	72	26-2209	72	26-2612	73	26-3105	75	26-3233	75	26-3451	76	26-5014	78	26-5514	80	27-1161	96
26-1823	72	26-2210	72	26-2614	73	26-3106	75	26-3234	75	26-3452	76	26-5015	78	26-5516	80	27-1162	96
26-1825	72	26-2212	72	26-2616	73	26-3107	75	26-3301	75	26-3453	76	26-5016	78	26-5518	80	27-1166	96
26-1827	72	26-2214	72	26-2618	73	26-3108	75	26-3302	75	26-3454	76	26-5017	78	26-5521	80	27-1167	96
26-1829	72	26-2216	72	26-2621	73	26-3109	75	26-3303	75	26-3455	76	26-5018	78	26-5522	80	27-1168	96
26-1831	72	26-2218	72	26-2623	73	26-3110	75	26-3304	75	26-3456	76	26-5019	78	26-5551	80	27-1169	96
26-1833	72	26-2221	72	26-2625	73	26-3111	75	26-3305	75	26-3457	76	26-5021	78	26-5552	80	27-1170	96
26-1835	72	26-2223	72	26-2627	73	26-3112	75	26-3306	75	26-4010	77	26-5023	78	26-5553	80	27-1171	96
26-1837	72	26-2225	72	26-2629	73	26-3113	75	26-3307	75	26-4012	77	26-5027	78	26-5554	80	27-1176	207
26-1906	72	26-2227	72	26-2707	73	26-3114	75	26-3308	75	26-4014	77	26-5106	78	27		27-1177	207
26-1907	72	26-2229	72	26-2708	73	26-3115	75	26-3309	75	26-4015	77	26-5107	78	27-1021	82	27-1181	96
26-1908	72	26-2309	72	26-2709	73	26-3116	75	26-3310	75	26-4016	77	26-5108	78	27-1022	82	27-1182	96
26-1909	72	26-2310	72	26-2710	73	26-3117	75	26-3311	75	26-4018	77	26-5109	78	27-1025	82	27-1183	96
26-1910	72	26-2312	72	26-2712	73	26-3118	75	26-3312	75	26-4021	77	26-5110	78	27-1026	82	27-1184	96
26-1912	72	26-2314	72	26-2714	73	26-3119	75	26-3313	75	26-4023	77	26-5112	78	27-1031	82	27-1185	96
26-1914	72	26-2316	72	26-2716	73	26-3120	75	26-3314	75	26-4110	77	26-5114	78	27-1032	82	27-1186	96
26-1915	72	26-2318	72	26-2718	73	26-3122	75	26-3315	75	26-4112	77	26-5116	78	27-1033	82	27-1187	96
26-1916	72	26-2321	72	26-2721	73	26-3123	75	26-3316	75	26-4115	77	26-5118	78	27-1034	82	27-1188	96
26-1918	72	26-2323	72	26-2723	73	26-3124	75	26-3317	75	26-4117	77	26-5208	78	27-1035	82	27-1189	96
26-1921	72	26-2325	72	26-2725	73	26-3125	75	26-3318	75	26-4120	77	26-5209	78	27-1036	82	27-1190	96
26-1923	72	26-2391	78	26-2727	73	26-3126	75	26-3319	75	26-4122	77	26-5210	78	27-1039	82	27-1201	97
26-1925	72	26-2392	78	26-2731	71	26-3127	75	26-3320	75	26-4125	77	26-5212	78	27-1051	83	27-1202	97
26-1927	72	26-2393	78	26-2732	71	26-3128	75	26-3322	75	26-4127	77	26-5214	78	27-1052	83	27-1203	97
26-1929	72	26-2394	78	26-2733	71	26-3129	75	26-3323	75	26-4130	77	26-5216	78	27-1053	83	27-1204	97
26-1931	72	26-2396	78	26-2734	71	26-3130	75	26-3324	75	26-4132	77	26-5218	78	27-1056	83	27-1205	97
26-1933	72	26-2397	78	26-2735	71	26-3131	75	26-3325	75	26-4135	77	26-5308	78	27-1057	83	27-1206	97
26-1935	72	26-2398	78	26-2736	71	26-3132	75	26-3326	75	26-4137	77	26-5309	78	27-1058	83	27-1207	97
26-1937	72	26-2399	78	26-2737	71	26-3133	75	26-3327	75	26-4140	77	26-5310	78	27-1061	83	27-1208	97
26-1940	72	26-2406	72	26-2738	71	26-3134	75	26-3328	75	26-4142	77	26-5312	78	27-1062	83	27-1209	97
26-1942	72	26-2407	72	26-2739	71	26-3201	75	26-3329	75	26-4145	77	26-5314	78	27-1066	83	27-1210	97
26-1945	72	26-2408	72	26-2740	71	26-3202	75	26-3330	75	26-4147	77	26-5316	78	27-1067	83	27-1211	97
26-1947	72	26-2409	72	26-2741	71	26-3203	75	26-3331	75	26-4150	77	26-5318	78	27-1071	85	27-1212	97
26-1950	72	26-2410	72	26-2742	71	26-3204	75	26-3332	75	26-4152	77	26-5321	78	27-1072	85	27-1215	97
26-2007	72	26-2411	72	26-2743	71	26-3205	75	26-3333	75	26-4155	77	26-5323	78	27-1073	85	27-1216	97
26-2008	72	26-2412	72	26-2744	71	26-3206	75	26-3334	75	26-4157	77	26-5412	78	27-1074	85	27-1217	97
26-2009	72	26-2413	72	26-2745	71	26-3207	75	26-3402	75	26-4160	77	26-5451	79	27-1075	85	27-1218	97
26-2010	72	26-2414	72	26-2746	71	26-3208	75	26-3403	75	26-4162	77	26-5452	79	27-1076	85	27-1219	97
26-2012	72	26-2415	72	26-2751	73	26-3209	75	26-3404	75	26-4165	77	26-5453	79	27-1077	85	27-1228	96
26-2014	72	26-2416	72	26-2752	73	26-3210	75	26-3405	75	26-4167	77	26-5454	79	27-1078	85	27-1231	97
26-2016	72	26-2418	72	26-2753	73	26-3211	75	26-3406	75	26-4170	77	26-5457	79	27-1081	94	27-1232	97
26-2018	72	26-2421	72	26-2754	73	26-3212	75	26-3407	75	26-4172	77	26-5458	79	27-1082	94	27-1233	97
26-2021	72	26-2423	72	26-2755	73	26-3213	75	26-3408	75	26-4175	77	26-5459	79	27-1085	94	27-1234	97
26-2023	72	26-2425	72	26-2756	73	26-3214	75	26-3409	75	26-4177	77	26-5461	79	27-1089	94	27-1235	97
26-2025	72	26-2496	77	26-2757	73	26-3215	75	26-3410	75	26-4180	77	26-5462	79	27-1091	94	27-1236	97
26-2027	72	26-2497	77	26-2761	74	26-3216	75	26-3411	75	26-4191	77	26-5463	79	27-1092	94	27-1241	98
26-2107	72	26-2498	77	26-2762	74	26-3217	75	26-3412	75	26-4192	77	26-5464	79	27-1111	95	27-1242	98
26-2108	72	26-2507	73	26-2763	74	26-3218	75	26-3413	75	26-4193	77	26-5465	79	27-1112	95	27-1243	98
26-2109	72	26-2508	73	26-2764	74	26-3219	75	26-3414	75	26-4194	77	26-5466	79	27-1114	95	27-1244	98
26-2110	72	26-2509	73	26-2765	74	26-3220	75	26-3415	75	26-5002	78	26-5467	79	27-1115	95	27-1245	98
26-2112	72	26-2510	73	26-2767	74	26-3222	75	26-3416	75	26-5003	79	26-5471	79	27-1121	95	27-1246	98
26-2114	72	26-2512	73	26-2768	74	26-3223	75	26-3417	75	26-5004	78	26-5472	79	27-1122	95	27-1247	98
26-2116	72	26-2514	73	26-3001	248	26-3224	75	26-3418	75	26-5005	78	26-5473	79	27-1131	95	27-1248	98
26-2118	72	26-2516	73	26-3002	248	26-3225	75	26-3419	75	26-5006	78	26-5475	79	27-1132	95	27-1249	98
26-2121	72	26-2518	73	26-3003	248	26-3226	75	26-3420	75	26-5007	78	26-5476	79	27-1133	95	27-1250	98
26-2123	72	26-2521	73	26-3006	76	26-3227	75	26-3422	75	26-5008	78	26-5477	79	27-1141	94	27-1254	98
26-2125	72	26-2523	73	26-3008	80	26-3228	75	26-3424	75	26-5009	78	26-5481	79	27-1142	94	27-1255	98
26-2127	72	26-2607	73	26-3101	75	26-3229	75	26-3426	75	26-5010	78	26-5482	79	27-1143	94	27-1261	99
26-2206	72	26-2608	73	26-3102	75	26-3230	75	26-3428	75	26-5011	78	26-5483	79	27-1144	94	27-1262	99
26-2207	72	26-2609	73	26-3103	75	26-3231	75	26-3430	75	26-5012	78	26-5484	79	27-1145	94	27-1266	99
26-2208	72	26-2610	73	26-3104	75	26-3232	75	26-3434	75	26-5013	78	26-5486	79	27-1146	94	27-1267	99

NEW # TO OLD



ITEM #	PG#	ITEM #	PG#	ITEM #	PG#	ITEM #	PG#	ITEM #	PG#	ITEM #	PG#	ITEM #	PG#	ITEM #	PG#		
27-1268	99	27-1381	92	27-1492	92	27-1594	88	27-1691	86	28-1032	107	28-1361	107	29-1063	111	30-1021	117
27-1269	99	27-1382	92	27-1494	92	27-1597	88	27-1692	86	28-1051	103	28-1362	107	29-1064	111	30-1022	117
27-1271	99	27-1383	92	27-1495	92	27-1598	88	27-1693	86	28-1052	103	28-1363	107	29-1065	111	30-1023	117
27-1272	99	27-1384	92	27-1497	92	27-1601	86	27-1695	86	28-1053	103	28-1364	107	29-1066	111	30-1024	117
27-1274	99	27-1391	92	27-1498	92	27-1602	86	27-1696	87	28-1054	103	28-1365	107	29-1067	111	30-1025	117
27-1276	99	27-1392	92	27-1500	90	27-1603	86	27-1697	87	28-1055	103	28-1366	106	29-1068	111	30-1026	117
27-1281	99	27-1393	92	27-1501	90	27-1604	86	27-1698	87	28-1056	103	28-1367	106	29-1069	111	30-1027	116
27-1282	99	27-1394	92	27-1502	90	27-1605	86	27-1699	87	28-1057	103	28-1368	106	29-1070	111	30-1028	116
27-1283	99	27-1395	92	27-1504	90	27-1606	86	27-1701	88	28-1061	103	28-1411	108	29-1071	111	30-1029	116
27-1284	99	27-1401	91	27-1506	90	27-1609	86	27-1702	88	28-1062	103	28-1412	108	29-1072	111	30-1030	116
27-1298	98	27-1406	91	27-1508	90	27-1611	84	27-1703	88	28-1063	103	28-1414	108	29-1073	111	30-1031	116
27-1299	98	27-1407	91	27-1511	90	27-1612	84	27-1707	88	28-1071	103	28-1415	108	29-1074	111	30-1032	116
27-1311	99	27-1408	91	27-1512	90	27-1613	84	27-1708	88	28-1072	103	28-1416	108	29-1075	111	30-1033	116
27-1312	99	27-1409	91	27-1513	90	27-1614	84	27-1711	87	28-1073	103	28-1417	108	29-1076	111	30-1034	116
27-1313	99	27-1411	91	27-1514	90	27-1615	84	27-1712	87	28-1074	103	28-1418	108	29-1081	111	30-1035	116
27-1314	99	27-1412	91	27-1517	90	27-1616	84	27-1715	87	28-1075	103	28-1419	108	29-1082	111	30-1036	116
27-1315	99	27-1413	91	27-1521	92	27-1617	84	27-1716	87	28-1076	103	28-1421	108	29-1083	111	30-1037	116
27-1316	99	27-1414	91	27-1522	92	27-1618	84	27-1717	87	28-1081	103	28-1424	108	29-1087	111	30-1038	116
27-1318	99	27-1415	91	27-1523	92	27-1621	84	27-1718	87	28-1082	103	28-1425	108	29-1088	111	30-1039	116
27-1321	100	27-1416	91	27-1524	92	27-1622	84	27-1721	87	28-1111	102	28-1426	108	29-1089	111	30-1040	116
27-1322	100	27-1417	91	27-1525	92	27-1623	84	27-1722	87	28-1112	102	28-1427	108	29-1091	111	30-1041	116
27-1323	100	27-1418	91	27-1526	92	27-1624	84	27-1723	87	28-1113	102	28-1431	108	29-1092	111	30-1042	116
27-1324	100	27-1419	91	27-1531	92	27-1625	84	27-1741	89	28-1114	102	28-1432	108	29-1093	111	30-1043	116
27-1327	100	27-1420	91	27-1532	92	27-1626	84	27-1742	89	28-1121	104	28-1433	108	29-1094	111	30-1044	116
27-1328	100	27-1422	91	27-1533	92	27-1627	84	27-1743	89	28-1122	104	29	29-1095	111	30-1045	116	
27-1331	100	27-1423	91	27-1534	92	27-1628	84	27-1744	89	28-1123	104	29-1011	110	29-1096	111	30-1046	116
27-1332	100	27-1424	91	27-1535	92	27-1633	84	27-1745	89	28-1131	104	29-1012	110	29-1097	111	30-1047	116
27-1335	100	27-1425	91	27-1536	92	27-1634	84	27-1746	89	28-1132	104	29-1014	110	29-1111	112	30-1048	116
27-1336	100	27-1431	91	27-1537	92	27-1636	84	27-1747	89	28-1133	104	29-1015	110	29-1112	112	30-1049	116
27-1337	100	27-1436	91	27-1541	92	27-1637	84	27-1751	89	28-1134	104	29-1018	110	29-1113	112	30-1050	116
27-1338	100	27-1438	91	27-1542	92	27-1638	84	27-1752	89	28-1141	104	29-1019	110	29-1114	112	30-1061	116
27-1339	100	27-1445	91	27-1543	92	27-1643	84	27-1753	89	28-1142	104	29-1021	110	29-1115	112	30-1062	116
27-1341	100	27-1446	91	27-1544	92	27-1644	84	27-2001	89	28-1143	104	29-1022	110	29-1116	112	30-1063	116
27-1342	100	27-1447	91	27-1551	91	27-1645	84	27-2011	89	28-1151	104	29-1024	110	29-1121	113	30-1064	116
27-1343	100	27-1448	91	27-1552	91	27-1646	84	27-2021	89	28-1152	104	29-1026	110	29-1122	113	30-1071	116
27-1351	93	27-1449	91	27-1555	90	27-1647	84	27-2031	89	28-1153	104	29-1028	110	29-1123	113	30-1072	116
27-1352	93	27-1450	91	27-1557	90	27-1648	84	27-2041	89	28-1161	104	29-1031	110	29-1126	113	30-1073	116
27-1353	93	27-1451	91	27-1559	90	27-1654	84	27-2051	89	28-1162	104	29-1040	111	29-1127	113	30-1074	116
27-1354	93	27-1452	91	27-1560	90	27-1658	84	27-2061	89	28-1171	104	29-1041	111	29-1131	113	30-1081	116
27-1355	93	27-1453	91	27-1561	88	27-1661	85	27-2071	89	28-1172	104	29-1042	111	29-1132	113	30-1082	116
27-1356	93	27-1454	91	27-1562	88	27-1662	85	27-2081	89	28-1211	105	29-1043	111	29-1133	113	30-1083	116
27-1357	93	27-1455	91	27-1563	88	27-1663	85	28		28-1212	105	29-1044	111	29-1134	113	30-1084	116
27-1358	93	27-1456	91	27-1564	88	27-1664	85	28-1011	102	28-1213	105	29-1045	111	29-1135	113	30-1091	116
27-1361	93	27-1457	91	27-1565	88	27-1665	85	28-1012	102	28-1221	105	29-1046	111	29-1136	113	30-1092	116
27-1362	93	27-1458	91	27-1566	88	27-1666	85	28-1013	102	28-1224	105	29-1047	111	29-1137	113	30-1111	117
27-1363	93	27-1462	91	27-1567	88	27-1667	85	28-1014	102	28-1225	105	29-1048	111	29-1138	113	30-1112	117
27-1364	93	27-1463	91	27-1571	88	27-1669	85	28-1015	102	28-1226	105	29-1049	111	29-1139	113	30-1113	117
27-1365	93	27-1466	100	27-1572	88	27-1671	86	28-1016	102	28-1227	105	29-1050	111	29-1140	113	30-1115	117
27-1366	93	27-1467	100	27-1573	88	27-1672	86	28-1017	102	28-1231	104	29-1051	111	29-1141	113	30-1116	117
27-1367	93	27-1468	100	27-1574	88	27-1673	86	28-1018	102	28-1233	104	29-1052	111	29-1151	114	30-1117	117
27-1368	93	27-1469	100	27-1575	88	27-1674	86	28-1019	102	28-1237	105	29-1053	111	29-1152	114	30-1121	117
27-1369	93	27-1471	91	27-1576	88	27-1675	86	28-1020	102	28-1238	105	29-1054	111	29-1153	114	30-1122	117
27-1371	93	27-1472	91	27-1581	88	27-1676	86	28-1021	102	28-1241	105	29-1055	111	29-1154	114	30-1123	117
27-1372	93	27-1473	91	27-1582	88	27-1677	86	28-1022	102	28-1351	107	29-1056	111	29-1161	114	30-1124	117
27-1373	93	27-1474	91	27-1583	88	27-1678	86	28-1023	102	28-1352	107	29-1057	111	30	30-1125	117	
27-1374	93	27-1481	91	27-1584	88	27-1679	86	28-1024	102	28-1353	107	29-1058	111	30-1011	116	30-1126	117
27-1375	93	27-1482	91	27-1587	88	27-1681	86	28-1026	102	28-1356	107	29-1059	111	30-1012	116	30-1131	117
27-1376	93	27-1483	91	27-1591	88	27-1683	86	28-1027	102	28-1357	107	29-1060	111	30-1013	116	30-1132	117
27-1378	93	27-1484	91	27-1592	88	27-1684	86	28-1028	102	28-1358	107	29-1061	111	30-1017	116	30-1133	117
27-1379	93	27-1485	91	27-1593	88	27-1685	86	28-1031	107	28-1359	107	29-1062	111	30-1018	116	30-1141	117

NUMERICAL INDEX



ITEM #	PG#	ITEM #	PG#	ITEM #	PG#	ITEM #	PG#	ITEM #	PG#	ITEM #	PG#	ITEM #	PG#	ITEM #	PG#		
33-1081	149	33-1173	150	33-1308	152	33-1397	156	33-1470	155	34-1211	161	35-1012	164	35-1123	170	37-1024	176
33-1082	149	33-1175	150	33-1309	152	33-1398	156	33-1471	155	34-1212	161	35-1013	164	35-1124	170	37-1036	176
33-1083	149	33-1176	150	33-1310	152	33-1399	156	33-1475	155	34-1213	161	35-1014	164	35-1125	170	37-1037	176
33-1084	149	33-1178	150	33-1311	152	33-1401	153	33-1476	155	34-1214	161	35-1016	164	35-1126	170	37-1038	176
33-1085	149	33-1179	150	33-1312	152	33-1402	153	33-1481	156	34-1215	161	35-1017	168	35-1135	123	37-1039	176
33-1087	149	33-1181	150	33-1313	152	33-1403	153	33-1482	156	34-1251	159	35-1018	168	35-1141	168	37-1040	176
33-1088	149	33-1182	150	33-1314	152	33-1404	153	33-1483	156	34-1252	159	35-1021	164	35-1142	168	37-1041	176
33-1089	149	33-1183	150	33-1315	152	33-1405	153	33-1484	156	34-1253	159	35-1022	164	35-1146	168	37-1042	176
33-1090	149	33-1184	150	33-1317	152	33-1406	153	33-1491	156	34-1254	159	35-1023	164	35-1147	168	37-1043	176
33-1102	149	33-1201	150	33-1319	152	33-1407	153	33-1492	156	34-1255	159	35-1024	164	35-1148	168	37-1044	176
33-1103	149	33-1202	150	33-1320	152	33-1408	153	34		34-1256	159	35-1026	164	35-1151	165	37-1045	176
33-1104	149	33-1203	150	33-1321	152	33-1411	153	34-1011	158	34-1257	159	35-1027	164	35-1155	165	37-1050	176
33-1105	149	33-1204	150	33-1322	152	33-1412	153	34-1012	158	34-1258	159	35-1028	164	35-1157	165	37-1051	176
33-1107	149	33-1205	150	33-1323	152	33-1413	153	34-1016	158	34-1259	159	35-1032	165	35-1159	165	37-1052	176
33-1108	149	33-1206	150	33-1324	152	33-1414	153	34-1017	158	34-1261	159	35-1034	166	35-1161	167	37-1053	176
33-1109	149	33-1207	150	33-1325	152	33-1415	153	34-1021	158	34-1262	159	35-1035	167	35-1162	167	37-1054	176
33-1112	149	33-1208	150	33-1329	152	33-1416	153	34-1022	158	34-1263	159	35-1036	167	35-1165	167	37-1055	176
33-1113	149	33-1209	150	33-1330	152	33-1417	153	34-1023	158	34-1264	159	35-1037	167	35-1166	167	37-1056	176
33-1114	149	33-1211	150	33-1334	152	33-1418	153	34-1024	158	34-1265	159	35-1038	167	35-1168	167	37-1057	176
33-1117	149	33-1212	150	33-1335	152	33-1421	153	34-1026	158	34-1266	159	35-1039	167	35-1171	128	37-1058	176
33-1118	149	33-1213	150	33-1339	152	33-1422	153	34-1031	158	34-1267	159	35-1041	166	35-1172	129	37-1059	176
33-1119	149	33-1214	150	33-1340	152	33-1423	153	34-1032	158	34-1268	159	35-1042	166	35-1173	129	37-1060	176
33-1120	149	33-1215	150	33-1342	152	33-1424	153	34-1035	158	34-1269	159	35-1044	165	35-1174	129	37-1061	176
33-1122	149	33-1216	150	33-1344	152	33-1425	153	34-1036	158	34-1271	159	35-1045	165	35-1175	129	37-1062	176
33-1123	149	33-1217	150	33-1345	152	33-1426	153	34-1055	160	34-1272	159	35-1047	167	35-1176	129	37-1063	176
33-1124	149	33-1218	150	33-1351	153	33-1427	153	34-1056	160	34-1281	159	35-1048	167	35-1185	129	37-1064	176
33-1127	149	33-1219	150	33-1352	153	33-1428	153	34-1058	160	34-1291	159	35-1049	167	35-1186	129	37-1065	176
33-1128	149	33-1221	150	33-1353	153	33-1431	153	34-1059	160	34-1292	159	35-1051	166	35-1188	129	37-1070	176
33-1129	149	33-1222	150	33-1354	153	33-1432	153	34-1061	160	34-1293	159	35-1052	166	35-1189	129	37-1071	176
33-1132	149	33-1223	150	33-1355	153	33-1433	153	34-1064	160	34-1330	162	35-1054	166	36		37-1072	176
33-1133	149	33-1241	151	33-1356	153	33-1434	153	34-1065	160	34-1331	162	35-1055	166	36-1011	171	37-1073	176
33-1134	149	33-1242	151	33-1357	153	33-1435	153	34-1066	160	34-1332	162	35-1057	166	36-1012	171	37-1074	176
33-1137	149	33-1251	151	33-1358	153	33-1436	153	34-1067	160	34-1333	162	35-1058	166	36-1015	172	37-1075	176
33-1138	149	33-1252	151	33-1361	153	33-1437	153	34-1068	160	34-1334	162	35-1060	166	36-1018	173	37-1076	176
33-1139	149	33-1253	151	33-1362	153	33-1438	153	34-1101	158	34-1335	162	35-1061	167	36-1019	173	37-1077	176
33-1142	151	33-1255	151	33-1363	153	33-1441	154	34-1102	158	34-1336	162	35-1062	167	36-1021	173	37-1078	176
33-1143	151	33-1256	151	33-1364	153	33-1442	154	34-1131	160	34-1337	162	35-1063	167	36-1031	174	37-1079	176
33-1144	151	33-1257	151	33-1365	153	33-1443	154	34-1132	160	34-1338	162	35-1068	166	36-1032	174	37-1080	176
33-1145	151	33-1261	151	33-1366	153	33-1444	154	34-1141	161	34-1339	162	35-1071	168	36-1041	174	37-1091	176
33-1146	151	33-1262	151	33-1367	153	33-1445	154	34-1142	161	34-1341	162	35-1073	168	36-1042	174	37-1092	176
33-1147	151	33-1263	151	33-1368	153	33-1446	154	34-1145	161	34-1342	162	35-1074	168	36-1051	174	37-1093	176
33-1148	151	33-1264	151	33-1371	153	33-1447	154	34-1146	161	34-1343	162	35-1077	168	36-1052	174	37-1111	176
33-1149	151	33-1265	151	33-1372	153	33-1448	154	34-1147	161	34-1344	162	35-1078	168	36-1053	174	37-1112	176
33-1151	151	33-1266	151	33-1373	153	33-1449	154	34-1148	161	34-1345	162	35-1081	169	36-1061	174	37-1113	176
33-1152	151	33-1281	156	33-1374	153	33-1450	154	34-1151	161	34-1346	162	35-1082	169	36-1062	174	37-1120	176
33-1153	151	33-1282	156	33-1375	153	33-1452	155	34-1153	161	34-1347	162	35-1084	170	36-1063	174	37-1121	176
33-1154	151	33-1283	156	33-1376	153	33-1453	155	34-1161	160	34-1361	159	35-1085	170	37		37-1122	176
33-1155	151	33-1284	156	33-1377	153	33-1455	155	34-1162	160	34-1363	159	35-1086	170	37-1008	176	37-1123	176
33-1156	151	33-1285	156	33-1378	153	33-1456	155	34-1171	161	34-1364	159	35-1087	170	37-1009	176	37-1124	176
33-1157	151	33-1291	156	33-1381	153	33-1458	155	34-1172	161	34-1365	159	35-1088	169	37-1010	176	37-1125	176
33-1158	151	33-1292	156	33-1382	153	33-1459	155	34-1173	161	34-1368	159	35-1089	169	37-1011	176	37-1126	176
33-1159	151	33-1293	156	33-1383	153	33-1460	155	34-1174	161	34-1381	162	35-1091	169	37-1012	176	37-1127	176
33-1162	151	33-1296	156	33-1384	153	33-1461	155	34-1175	161	34-1383	162	35-1092	169	37-1013	176	37-1128	176
33-1163	151	33-1301	152	33-1385	153	33-1462	155	34-1176	161	34-1384	162	35-1093	169	37-1014	176	37-1129	176
33-1165	151	33-1302	152	33-1386	153	33-1463	155	34-1177	161	34-1391	162	35-1106	169	37-1015	176	37-1130	176
33-1166	151	33-1303	152	33-1387	153	33-1464	155	34-1178	161	34-1393	162	35-1107	169	37-1016	176	37-1143	176
33-1168	151	33-1304	152	33-1388	153	33-1465	155	34-1181	161	34-1394	162	35-1108	169	37-1020	176	37-1144	176
33-1169	151	33-1305	152	33-1391	156	33-1466	155	34-1191	161			35-1109	169	37-1021	176	37-1145	176
33-1171	150	33-1306	152	33-1392	156	33-1467	155	34-1192	161	35		35-1121	170	37-1022	176	37-1146	176
33-1172	150	33-1307	152	33-1393	156	33-1468	155	34-1193	161	35-1011	164	35-1122	170	37-1023	176	37-1147	176



NEW # TO OLD

ITEM #	PG#	ITEM #	PG#	ITEM #	PG#	ITEM #	PG#	ITEM #	PG#	ITEM #	PG#	ITEM #	PG#	ITEM #	PG#		
42-1152	226	42-1352	227	43-1048	232	43-1192	236	44-1203	242	45-1194	226	46-1168	247	47-1026	251	47-1332	256
42-1153	226	42-1353	227	43-1051	233	43-1211	236	44-1212	242	46		46-1169	247	47-1028	251	47-1333	256
42-1154	226	42-1354	227	43-1056	233	43-1212	236	44-1213	242	46-1011	246	46-1170	247	47-1029	251	47-1341	256
42-1155	226	42-1361	227	43-1057	233	43-1213	236	44-1215	242	46-1014	246	46-1171	247	47-1031	251	47-1342	256
42-1161	226	42-1362	227	43-1061	233	43-1214	236	44-1221	242	46-1015	246	46-1172	247	47-1034	251	47-1343	256
42-1164	226	42-1363	227	43-1064	233	43-1215	236	44-1225	242	46-1021	246	46-1173	247	47-1036	251	47-1366	250
42-1166	226	42-1364	227	43-1071	233	43-1216	236	44-1231	242	46-1022	246	46-1181	247	47-1038	251	47-1367	250
42-1167	226	42-1371	227	43-1081	234	43-1217	236	44-1241	242	46-1031	246	46-1182	247	47-1041	251	47-1372	250
42-1169	226	42-1381	229	43-1084	234	43-1218	236	44-1251	242	46-1032	246	46-1183	247	47-1042	251	47-1373	250
42-1171	227	42-1382	229	43-1085	234	43-1219	236	44-1261	242	46-1033	246	46-1184	247	47-1150	253	47-1375	250
42-1211	228	42-1391	56	43-1091	235	43-1220	236	44-1262	242	46-1041	246	46-1185	247	47-1151	252	47-1376	250
42-1212	228	42-1392	56	43-1094	235	43-1221	236	44-1263	242	46-1042	246	46-1186	247	47-1153	252	47-1381	250
42-1213	228	42-1393	56	43-1095	235	43-1222	236	44-1267	242	46-1043	246	46-1187	247	47-1154	252	47-1392	250
42-1214	228	42-1406	230	43-1111	235	43-1231	234	44-1271	242	46-1044	246	46-1188	247	47-1155	252	48	
42-1221	228	42-1407	230	43-1112	235	44		44-1272	242	46-1045	246	46-1189	247	47-1156	252	48-1011	258
42-1222	228	42-1408	230	43-1113	235	44-1011	241	44-1281	242	46-1046	246	46-1190	247	47-1157	252	48-1012	258
42-1223	228	42-1409	230	43-1114	235	44-1012	241	44-1291	242	46-1051	246	46-1191	247	47-1159	252	48-1013	258
42-1224	228	42-1411	230	43-1121	235	44-1013	241	44-1292	242	46-1052	246	46-1192	247	47-1161	252	48-1014	258
42-1225	228	42-1412	230	43-1122	235	44-1021	241	44-1293	242	46-1053	246	46-1193	247	47-1163	252	48-1015	258
42-1226	228	42-1416	230	43-1123	235	44-1022	241	44-1301	242	46-1054	246	46-1201	247	47-1165	252	48-1016	258
42-1231	228	42-1417	230	43-1124	235	44-1023	241	44-1303	242	46-1055	246	46-1202	247	47-1171	253	48-1017	258
42-1232	228	42-1418	230	43-1131	236	44-1026	241	44-1311	242	46-1056	246	46-1203	247	47-1172	253	48-1018	258
42-1233	228	42-1431	230	43-1132	236	44-1027	241	45		46-1059	246	46-1204	247	47-1173	253	48-1019	258
42-1234	228	42-1432	230	43-1133	236	44-1028	314	45-1011	244	46-1081	246	46-1205	247	47-1174	253	48-1020	258
42-1235	228	42-1441	230	43-1134	236	44-1112	238	45-1012	244	46-1082	246	46-1206	247	47-1175	253	48-1021	258
42-1241	228	42-1442	230	43-1141	236	44-1113	238	45-1015	244	46-1083	246	46-1207	247	47-1176	253	48-1032	258
42-1242	228	42-1444	230	43-1142	236	44-1114	238	45-1016	244	46-1084	246	46-1208	247	47-1181	253	48-1033	258
42-1245	228	42-1445	230	43-1143	236	44-1122	238	45-1018	244	46-1085	246	46-1209	247	47-1182	253	48-1034	258
42-1247	228	42-1447	230	43-1144	236	44-1123	238	45-1021	244	46-1121	247	46-1210	247	47-1183	253	48-1035	258
42-1251	228	42-1448	230	43-1145	236	44-1124	238	45-1022	244	46-1122	247	46-1211	247	47-1184	253	48-1036	258
42-1252	228	42-1451	230	43-1146	236	44-1126	238	45-1023	244	46-1123	247	46-1212	247	47-1185	253	48-1037	258
42-1256	228	42-1452	230	43-1147	236	44-1132	238	45-1024	244	46-1124	247	46-1213	247	47-1191	252	48-1039	258
42-1257	228	42-1453	230	43-1148	236	44-1133	238	45-1025	244	46-1125	247	46-1251	247	47-1192	252	48-1040	258
42-1261	229	42-1510	230	43-1149	236	44-1134	238	45-1031	244	46-1126	247	46-1252	247	47-1193	252	48-1041	258
42-1262	229	42-1511	230	43-1150	236	44-1136	239	45-1041	227	46-1127	247	46-1253	247	47-1194	252	48-1051	258
42-1265	229	42-1512	230	43-1151	236	44-1137	239	45-1042	227	46-1128	247	46-1254	247	47-1195	252	48-1052	258
42-1271	229	42-1513	230	43-1152	236	44-1138	239	45-1051	227	46-1129	247	46-1255	247	47-1196	252	48-1053	258
42-1272	229	42-1514	230	43-1161	236	44-1141	239	45-1052	227	46-1130	247	46-1256	247	47-1211	254	48-1054	258
42-1275	229	42-1515	230	43-1162	236	44-1142	239	45-1053	227	46-1131	247	46-1257	247	47-1221	254	48-1055	258
42-1281	229	42-1516	230	43-1163	236	44-1146	239	45-1054	227	46-1132	247	46-1258	247	47-1222	254	48-1056	258
42-1282	229	42-1517	230	43-1164	236	44-1151	241	45-1055	227	46-1141	247	46-1259	247	47-1223	254	48-1057	258
42-1285	229	42-1521	230	43-1165	236	44-1152	241	45-1061	244	46-1142	247	46-1260	247	47-1231	254	48-1058	258
42-1291	229	42-1524	230	43-1166	236	44-1153	241	45-1062	244	46-1143	247	46-1261	247	47-1232	254	48-1061	258
42-1292	229	42-1527	230	43-1167	236	44-1154	241	45-1066	244	46-1144	247	46-1286	248	47-1241	254	48-1062	258
42-1295	229	43		43-1168	236	44-1156	241	45-1067	244	46-1145	247	46-1287	248	47-1248	256	48-1063	258
42-1311	227	43-1011	232	43-1169	236	44-1161	240	45-1068	244	46-1146	247	46-1288	248	47-1251	255	48-1064	258
42-1312	227	43-1012	232	43-1170	236	44-1162	240	45-1071	244	46-1147	247	46-1289	248	47-1252	255	48-1065	258
42-1316	227	43-1021	232	43-1171	236	44-1166	240	45-1072	244	46-1148	247	46-1290	248	47-1253	255	48-1066	258
42-1317	227	43-1022	232	43-1172	236	44-1167	240	45-1076	244	46-1149	247	46-1291	248	47-1262	255	48-1067	258
42-1321	227	43-1023	232	43-1181	236	44-1171	240	45-1077	244	46-1150	247	46-1311	248	47-1271	255	48-1068	258
42-1324	227	43-1024	232	43-1182	236	44-1172	240	45-1081	206	46-1151	247	46-1312	248	47-1272	255	48-1071	258
42-1325	227	43-1031	232	43-1183	236	44-1176	240	45-1082	206	46-1152	247	46-1331	248	47-1281	255	48-1072	258
42-1326	227	43-1032	232	43-1184	236	44-1177	240	45-1083	206	46-1153	247	46-1332	248	47-1282	255	48-1076	316
42-1341	227	43-1036	232	43-1185	236	44-1181	240	45-1093	244	46-1161	247	46-1333	248	47-1283	255	48-1081	258
42-1342	227	43-1037	232	43-1186	236	44-1182	240	45-1094	244	46-1162	247	47		47-1284	255	48-1082	258
42-1344	227	43-1038	232	43-1187	236	44-1191	241	45-1095	227	46-1163	247	47-1011	251	47-1311	256	48-1085	258
42-1345	227	43-1041	232	43-1188	236	44-1192	241	45-1096	227	46-1164	247	47-1015	251	47-1321	256	48-1086	258
42-1346	227	43-1042	232	43-1189	236	44-1195	241	45-1099	226	46-1165	247	47-1021	251	47-1322	256	48-1088	258
42-1347	227	43-1043	232	43-1190	236	44-1201	242	45-1192	226	46-1166	247	47-1024	251	47-1323	256	49	
42-1351	227	43-1045	232	43-1191	236	44-1202	242	45-1193	226	46-1167	247	47-1025	251	47-1331	256	49-1011	260

NUMERICAL INDEX



ITEM #	PG#	ITEM #	PG#	ITEM #	PG#	ITEM #	PG#	ITEM #	PG#	ITEM #	PG#	ITEM #	PG#	ITEM #	PG#		
49-1015	262	49-1226	266	50-1114	271	50-1311	274	51-1042	276	51-1233	276	51-1397	277	51-1741	277	52-1061	284
49-1016	262	49-1227	321	50-1116	271	50-1312	274	51-1051	276	51-1241	276	51-1401	278	51-1742	277	52-1062	284
49-1019	262	49-1228	266	50-1117	271	50-1314	274	51-1052	276	51-1242	276	51-1402	278	51-1751	277	52-1064	284
49-1021	262	49-1229	266	50-1118	271	50-1315	274	51-1053	276	51-1251	276	51-1405	278	51-1752	277	52-1065	284
49-1022	262	49-1235	266	50-1119	271	50-1316	274	51-1054	276	51-1252	276	51-1406	278	51-1753	277	52-1066	284
49-1023	262	49-1236	266	50-1121	271	50-1318	274	51-1055	276	51-1253	276	51-1407	278	51-1754	277	52-1071	284
49-1027	262	49-1251	265	50-1122	270	50-1319	274	51-1056	276	51-1254	276	51-1408	278	51-1755	277	52-1072	284
49-1028	262	49-1254	265	50-1131	271	50-1320	274	51-1057	276	51-1255	276	51-1409	278	51-1756	277	52-1075	284
49-1031	262	49-1255	265	50-1132	271	50-1350	274	51-1058	276	51-1256	276	51-1410	278	51-1757	277	52-1076	284
49-1033	262	49-1256	265	50-1136	271	50-1351	274	51-1059	276	51-1257	276	51-1571	277	51-1758	277	52-1077	284
49-1041	263	49-1257	265	50-1137	271	50-1352	274	51-1060	276	51-1258	276	51-1572	277	51-1759	277	52-1078	284
49-1042	263	49-1258	265	50-1141	271	50-1354	274	51-1061	276	51-1259	276	51-1573	277	51-1809	277	52-1101	282
49-1043	263	49-1259	265	50-1142	271	50-1355	274	51-1062	276	51-1260	276	51-1574	277	51-1810	277	52-1102	282
49-1044	263	49-1261	265	50-1143	271	50-1356	274	51-1063	276	51-1261	276	51-1577	277	51-1812	277	52-1105	282
49-1047	263	50		50-1154	271	50-1358	274	51-1064	276	51-1262	276	51-1578	277	51-1814	277	52-1111	282
49-1100	264	50-1011	268	50-1155	271	50-1359	274	51-1065	276	51-1263	276	51-1581	277	51-1818	277	52-1112	282
49-1101	264	50-1012	268	50-1161	272	50-1410	274	51-1109	276	51-1264	276	51-1582	277	51-1821	277	52-1115	282
49-1102	264	50-1015	268	50-1162	272	50-1414	274	51-1110	276	51-1265	276	51-1583	277	51-1822	277	52-1121	282
49-1103	264	50-1016	268	50-1163	272	50-1415	274	51-1112	276	51-1309	276	51-1609	278	51-1824	277	52-1122	282
49-1104	264	50-1021	45	50-1170	272	50-1416	274	51-1114	276	51-1310	276	51-1610	278	51-1825	277	52-1125	282
49-1105	264	50-1022	45	50-1171	272	50-1418	274	51-1115	276	51-1312	276	51-1612	278	51-1826	277	52-1131	282
49-1106	264	50-1023	45	50-1172	272	50-1454	274	51-1118	276	51-1314	276	51-1614	278	51-1841	277	52-1132	282
49-1107	264	50-1024	45	50-1173	272	50-1455	274	51-1121	276	51-1315	276	51-1615	278	51-1842	277	52-1135	282
49-1108	264	50-1025	45	50-1174	272	50-1465	274	51-1122	276	51-1318	276	51-1618	278	51-1851	277	52-1141	282
49-1109	264	50-1027	269	50-1181	272	50-1466	274	51-1124	276	51-1321	276	51-1620	278	51-1852	277	52-1142	282
49-1110	264	50-1028	269	50-1182	272	50-1471	274	51-1125	276	51-1322	276	51-1621	278	51-1853	277	52-1143	283
49-1111	264	50-1029	269	50-1183	272	50-1472	274	51-1126	276	51-1324	276	51-1622	278	51-1854	277	52-1144	283
49-1112	264	50-1031	45	50-1184	272	50-1473	274	51-1131	278	51-1325	276	51-1624	278	51-1855	277	52-1145	282
49-1113	264	50-1032	45	50-1185	272	50-1501	274	51-1132	276	51-1326	276	51-1631	278	51-1856	277	52-1151	282
49-1114	264	50-1034	269	50-1186	272	50-1502	274	51-1133	276	51-1331	276	51-1632	278	51-1857	277	52-1152	282
49-1115	264	50-1041	269	50-1187	272	50-1503	274	51-1141	276	51-1332	276	51-1633	278	51-1858	277	52-1155	282
49-1116	264	50-1042	269	50-1188	272	50-1504	274	51-1142	276	51-1333	276	51-1641	278	51-1859	277	52-1161	283
49-1117	264	50-1043	269	50-1189	272	50-1505	274	51-1151	278	51-1341	276	51-1642	278	52		52-1162	283
49-1118	264	50-1044	269	50-1191	273	50-1510	274	51-1152	276	51-1342	276	51-1651	278	52-1001	283	52-1163	283
49-1119	264	50-1046	269	50-1192	273	50-1512	274	51-1153	276	51-1351	276	51-1652	278	52-1002	283	52-1164	283
49-1120	264	50-1047	269	50-1194	272	50-1514	274	51-1154	278	51-1352	276	51-1661	278	52-1004	283	52-1165	283
49-1121	264	50-1048	269	50-1195	273	50-1521	274	51-1155	278	51-1353	276	51-1662	278	52-1005	283	52-1171	283
49-1122	264	50-1051	269	50-1196	273	50-1522	274	51-1156	278	51-1354	276	51-1663	278	52-1011	283	52-1172	283
49-1131	264	50-1052	269	50-1198	273	50-2021	273	51-1157	276	51-1355	276	51-1664	278	52-1012	283	52-1175	283
49-1132	264	50-1061	270	50-1206	274	50-2024	273	51-1158	278	51-1356	276	51-1665	278	52-1015	283	52-1176	283
49-1135	264	50-1062	270	50-1210	274	50-2027	273	51-1159	276	51-1357	276	51-1666	278	52-1016	283	52-1181	283
49-1136	264	50-1066	270	50-1211	274	50-2028	273	51-1160	276	51-1358	276	51-1667	278	52-1017	283	52-1182	283
49-1141	264	50-1067	270	50-1212	274	50-2029	273	51-1161	276	51-1359	276	51-1668	278	52-1018	283	52-1185	283
49-1142	264	50-1071	270	50-1214	274	50-2031	273	51-1162	276	51-1360	276	51-1669	278	52-1021	283	52-1186	283
49-1143	264	50-1072	270	50-1215	274	51		51-1163	276	51-1361	276	51-1670	278	52-1022	283	52-1188	283
49-1144	264	50-1074	270	50-1216	274	51-1009	276	51-1164	276	51-1362	276	51-1671	278	52-1025	283	52-1189	283
49-1145	264	50-1075	270	50-1218	274	51-1010	276	51-1165	276	51-1363	276	51-1672	278	52-1026	283	52-1191	283
49-1151	265	50-1081	270	50-1219	274	51-1012	276	51-1209	276	51-1364	276	51-1673	278	52-1027	283	52-1192	283
49-1152	265	50-1082	270	50-1220	274	51-1014	276	51-1210	276	51-1365	276	51-1675	278	52-1028	283	52-1195	283
49-1156	265	50-1083	270	50-1250	274	51-1015	276	51-1212	276	51-1381	276	51-1677	278	52-1031	283	52-1211	283
49-1157	265	50-1086	270	50-1251	274	51-1018	276	51-1214	276	51-1382	276	51-1709	277	52-1032	283	52-1212	283
49-1159	265	50-1087	270	50-1252	274	51-1021	276	51-1215	276	51-1383	276	51-1710	277	52-1035	283	52-1221	285
49-1211	265	50-1088	270	50-1254	274	51-1022	276	51-1218	276	51-1384	276	51-1712	277	52-1041	283	52-1222	285
49-1212	265	50-1091	270	50-1255	274	51-1024	276	51-1221	276	51-1386	276	51-1714	277	52-1042	283	52-1225	285
49-1213	265	50-1092	270	50-1256	274	51-1025	276	51-1222	276	51-1387	276	51-1718	277	52-1045	283	52-1231	285
49-1217	265	50-1093	270	50-1258	274	51-1026	276	51-1224	276	51-1388	276	51-1721	277	52-1051	284	52-1232	285
49-1221	266	50-1101	271	50-1259	274	51-1031	276	51-1225	276	51-1389	276	51-1722	277	52-1052	284	52-1235	285
49-1222	266	50-1111	271	50-1260	274	51-1032	276	51-1226	276	51-1391	276	51-1724	277	52-1055	284	52-1241	285
49-1223	266	50-1112	271	50-1306	274	51-1033	276	51-1231	276	51-1392	276	51-1725	277	52-1056	284	52-1242	285
49-1225	266	50-1113	271	50-1310	274	51-1041	276	51-1232	276	51-1393	276	51-1726	277	52-1057	284	52-1245	285



NEW # TO OLD

ITEM #	PG#	ITEM #	PG#	ITEM #	PG#	ITEM #	PG#	ITEM #	PG#	ITEM #	PG#	ITEM #	PG#	ITEM #	PG#		
52-1251	284	52-1501	286	53-1041	290	53-1254	291	53-1384	292	55-1019	298	55-1192	302	56-1011	118	56-1173	311
52-1252	284	52-1502	286	53-1042	290	53-1255	291	53-1391	292	55-1021	298	55-1193	302	56-1012	118	56-1174	311
52-1255	284	52-1511	287	53-1043	290	53-1256	291	53-2001	348	55-1022	298	55-1194	302	56-1013	118	56-1181	309
52-1261	284	52-1512	287	53-1044	290	53-1261	291	53-2020	348	55-1023	298	55-1195	302	56-1014	118	56-1183	309
52-1262	284	52-1515	287	53-1045	290	53-1262	291	53-2031	348	55-1024	298	55-1196	302	56-1015	118	56-1211	311
52-1271	284	52-1516	287	53-1046	290	53-1263	291	53-2032	348	55-1027	305	55-1201	303	56-1021	118	56-1213	311
52-1272	284	52-1517	287	53-1051	290	53-1266	291	53-2130	348	55-1028	305	55-1204	303	56-1022	118	56-1215	311
52-1275	284	52-1518	287	53-1052	290	53-1267	291	53-2131	348	55-1031	299	55-1205	303	56-1023	118	56-1217	311
52-1311	285	52-1522	287	53-1053	290	53-1269	291	53-2140	348	55-1032	299	55-1206	303	56-1024	118	56-1221	311
52-1312	285	52-1524	287	53-1054	290	53-1270	291	53-2141	348	55-1033	299	55-1207	303	56-1025	118	56-1222	311
52-1315	285	52-1525	287	53-1055	290	53-1271	291	53-2153	348	55-1034	299	55-1211	304	56-1025	118	56-1222	311
52-1316	285	52-1531	287	53-1061	290	53-1273	291	53-2163	348	55-1042	299	55-1212	304	56-1032	118	56-1223	311
52-1319	285	52-1532	287	53-1064	290	53-1275	291	54		55-1043	299	55-1221	304	56-1033	118	56-1224	311
52-1320	285	52-1535	287	53-1065	290	53-1277	291	54-1011	294	55-1044	299	55-1222	304	56-1034	118	56-1225	311
52-1323	285	52-1541	287	53-1071	290	53-1279	291	54-1012	294	55-1045	299	55-1223	304	56-1035	118	56-1226	311
52-1324	285	52-1542	287	53-1074	290	53-1280	291	54-1015	294	55-1046	299	55-1224	304	56-1042	118	56-1227	311
52-1331	285	52-1543	287	53-1075	290	53-1281	291	54-1017	294	55-1047	299	55-1225	304	56-1043	118	56-1228	311
52-1340	285	52-1544	287	53-1081	290	53-1282	291	54-1021	294	55-1054	299	55-1231	306	56-1044	118	56-1231	312
52-1351	285	52-1546	287	53-1084	290	53-1286	291	54-1025	294	55-1063	299	55-1232	306	56-1045	118	56-1234	312
52-1352	285	52-1547	287	53-1085	290	53-1287	291	54-1029	294	55-1064	299	55-1233	306	56-1053	118	56-1241	268
52-1355	285	52-1548	287	53-1091	290	53-1288	291	54-1030	294	55-1065	299	55-1234	306	56-1054	118	56-1242	268
52-1356	285	52-1553	287	53-1095	290	53-1289	291	54-1031	294	55-1066	299	55-1235	306	56-1055	118	56-1251	312
52-1359	285	52-1561	287	53-1111	290	53-1290	291	54-1035	294	55-1071	299	55-1238	306	56-1056	118	56-1252	312
52-1360	285	52-1562	287	53-1112	290	53-1291	291	54-1042	294	55-1081	300	55-1239	306	56-1063	118	56-1253	312
52-1363	285	52-1563	287	53-1113	290	53-1293	291	54-1043	294	55-1082	300	55-1241	306	56-1064	118	56-1254	312
52-1364	285	52-1564	287	53-1121	290	53-1295	291	54-1046	294	55-1088	300	55-1242	306	56-1065	118	56-1261	312
52-1371	285	52-1565	287	53-1122	290	53-1297	291	54-1047	294	55-1111	300	55-1243	306	56-1066	118	56-1262	312
52-1380	285	52-1567	287	53-1123	290	53-1299	291	54-1049	294	55-1112	300	55-1244	306	56-1066	118	56-1262	312
52-1410	288	52-1711	288	53-1131	290	53-1300	291	54-1051	294	55-1113	300	55-1243	306	56-1073	118	56-1263	312
52-1412	288	52-1721	288	53-1132	290	53-1311	292	54-1052	294	55-1114	300	55-1251	306	56-1074	118	56-1266	312
52-1414	288	52-1722	288	53-1133	290	53-1312	292	54-1053	294	55-1121	300	55-1261	305	56-1075	118	56-1271	312
52-1416	288	52-1723	288	53-1141	290	53-1313	292	54-1057	294	55-1122	300	55-1262	305	56-1083	118	56-1272	312
52-1418	288	52-1731	288	53-1142	290	53-1314	292	54-1058	294	55-1123	300	55-1274	303	56-1084	118	56-1273	312
52-1420	286	52-1732	288	53-1143	290	53-1321	292	54-1061	294	55-1124	300	55-1275	303	56-1111	119	56-1281	312
52-1422	286	52-1735	288	53-1151	290	53-1322	292	54-1062	294	55-1131	300	55-1276	303	56-1112	119	56-1282	312
52-1424	286	52-1736	288	53-1152	290	53-1323	292	54-1063	294	55-1132	300	55-1281	304	56-1113	119	56-1291	312
52-1426	286	52-1741	288	53-1153	290	53-1324	292	54-1064	294	55-1135	300	55-1282	304	56-1114	119	56-1292	312
52-1428	286	52-1742	288	53-1211	291	53-1325	292	54-1066	294	55-1136	300	55-1283	304	56-1115	309	56-1295	268
52-1431	288	52-1761	288	53-1212	291	53-1331	292	54-1067	294	55-1137	300	55-1287	304	56-1122	119	56-1311	105
52-1433	288	52-1763	288	53-1213	291	53-1333	292	54-1071	294	55-1138	300	55-1288	304	56-1123	119	56-1312	105
52-1435	288	52-1764	288	53-1214	291	53-1334	292	54-1091	295	55-1139	300	55-1289	304	56-1124	119	56-1313	105
52-1451	286	53		53-1215	291	53-1335	292	54-1092	295	55-1141	300	55-1291	305	56-1131	119	57	
52-1452	286	53-1011	290	53-1221	291	53-1336	292	54-1092	295	55-1142	300	55-1292	305	56-1132	119	57-1011	314
52-1453	286	53-1012	290	53-1222	291	53-1341	292	54-1111	295	55-1145	303	55-1293	305	56-1133	119	57-1012	314
52-1454	286	53-1013	290	53-1223	291	53-1342	292	54-1114	295	55-1146	303	55-1298	306	56-1134	119	57-1013	314
52-1461	286	53-1014	290	53-1224	291	53-1343	292	54-1121	125	55-1147	303	55-1299	306	56-1141	309	57-1021	314
52-1462	286	53-1015	290	53-1225	291	53-1344	292	54-1122	125	55-1151	301	55-1301	306	56-1142	309	57-1022	314
52-1463	286	53-1016	290	53-1231	293	53-1351	292	54-1130	124	55-1152	301	55-1302	306	56-1143	309	57-1023	314
52-1464	286	53-1021	290	53-1232	293	53-1352	292	54-1131	124	55-1153	301	55-1303	306	56-1144	309	57-1024	314
52-1467	286	53-1022	290	53-1233	293	53-1353	292	54-1132	124	55-1161	301	55-1304	306	56-1145	309	57-1025	314
52-1471	286	53-1023	290	53-1234	293	53-1354	292	54-1134	124	55-1162	301	55-1305	306	56-1146	268	57-1031	314
52-1473	286	53-1024	290	53-1235	293	53-1361	292	54-1135	124	55-1165	301	55-1310	306	56-1147	268	57-1041	314
52-1481	286	53-1025	290	53-1241	293	53-1362	292	54-1136	124	55-1166	301	55-1311	306	56-1148	268	57-1051	314
52-1483	286	53-1026	290	53-1242	293	53-1365	292	54-1137	125	55-1171	201	55-1312	306	56-1151	268	57-1052	314
52-1490	286	53-1031	290	53-1243	293	53-1366	292	54-1139	125	55-1172	301	55-1313	306	56-1153	310	57-1061	314
52-1491	286	53-1032	290	53-1244	293	53-1366	292	54-1141	125	55-1176	301	55-1315	306	56-1158	268	57-1062	314
52-1492	286	53-1033	290	53-1245	293	53-1371	292	55		55-1177	301	55-1316	306	56-1161	310	57-1071	314
52-1493	286	53-1034	290	53-1251	291	53-1372	292	55-1011	298	55-1178	301	55-1317	306	56-1163	310	58	
52-1494	286	53-1035	290	53-1252	291	53-1374	292	55-1013	298	55-1181	302	55-1318	306	56-1165	310	58-1004	316
52-1495	286	53-1036	290	53-1253	291	53-1381	292	55-1015	298	55-1182	302	55-1319	306	56-1167	310	58-1005	316
						53-1382	292	55-1017	298	55-1184	302	55-1320	306	56-1171	311	58-1009	316
										55-1191	302	56		56-1172	311	58-1011	316



NEW # TO OLD

ITEM #	PG#	ITEM #	PG#	ITEM #	PG#	ITEM #	PG#	ITEM #	PG#	ITEM #	PG#	ITEM #	PG#	ITEM #	PG#
59-1802	344	59-2771	335	59-3102	339	61-1042	33	64-001W	207	64-301W	207	64-605G	207		
59-1803	344	59-2772	335	59-3103	339	61-1043	33	64-002G	207	64-302G	207	64-605W	207		
59-1804	344	59-2773	336	59-3104	339	61-1044	33	64-002W	207	64-302W	207	64-609G	207		
59-1805	344	59-2774	336	59-3105	339	61-1051	33	64-003G	207	64-303G	207	64-701G	207		
59-1806	344	59-2775	336	59-3106	339	61-1052	34	64-003W	207	64-303W	207	64-701W	207		
59-1807	344	59-2776	336	59-3110	339	61-1053	34	64-004G	207	64-304G	207	64-702G	207		
59-1808	344	59-2777	336	59-3112	339	61-1061	34	64-004W	207	64-304W	207	64-702W	207		
59-1809	344	59-2778	336	59-3113	339	61-1062	34	64-005G	207	64-305G	207	64-8000	207		
59-1810	344	59-2779	336	59-3114	339	61-1063	34	64-005W	207	64-305W	207	64-821GM	207		
59-1911	332	59-2781	336	59-3115	339	61-1071	34	64-006G	207	64-306G	207	64-821WM	207		
59-1912	332	59-2782	336	59-3116	339	61-1072	34	64-006W	207	64-306W	207	64-822GM	207		
59-1916	332	59-2783	336	59-3200	338	61-1073	34	64-007G	207	64-307G	207	64-822WM	207		
59-1921	332	59-2784	336	59-5121	50	61-1074	34	64-007W	207	64-307W	207	64-823GM	207		
59-1922	332	59-2785	336	59-5122	50	61-1075	34	64-008G	207	64-308G	207	64-823WM	207		
59-1926	332	59-2786	336	59-5123	50	61-1076	35	64-008W	207	64-308W	207	64-824GM	207		
59-2690	334	59-2787	336	60		61-1111	35	64-009G	207	64-309W	207	64-824WM	207		
59-2691	334	59-2788	336	60-1011	345	61-1112	35	64-009W	207	64-310G	207	64-825GM	207		
59-2692	334	59-2789	336	60-1012	345	61-1113	35	64-010G	207	64-310W	207	64-825WM	207		
59-2693	334	59-2790	336	60-1013	345	61-1114	35	64-010W	207	64-311G	207	64-826GM	207		
59-2694	334	59-2791	336	60-1014	346	61-1115	35	64-011G	207	64-311W	207	64-826WM	207		
59-2695	334	59-2792	336	60-1015	346	61-1121	37	64-011W	207	64-312G	207	64-827GM	207		
59-2696	334	59-2801	337	60-1016	346	61-1122	38	64-012G	207	64-312W	207	64-827WM	207		
59-2697	334	59-2802	337	60-1017	345	61-1123	38	64-012W	207	64-313G	207	64-828GM	207		
59-2698	334	59-2803	337	60-1018	345	61-1124	38	64-013G	207	64-313W	207	64-828WM	207		
59-2699	334	59-2804	337	60-1019	346	61-1125	38	64-013W	207	64-401G	207	64-829GM	207		
59-2700	334	59-2810	338	60-1020	345	61-1126	38	64-014G	207	64-401W	207	64-829WM	207		
59-2701	334	59-2811	338	60-1021	346	61-1127	38	64-201GM	207	64-402G	207	64-830GM	207		
59-2702	334	59-2812	338	60-1022	346	61-1128	37	64-201WM	207	64-402W	207	64-830WM	207		
59-2703	334	59-2815	338	60-1023	346	61-1129	38	64-202GM	207	64-403G	207	64-831-GM	207		
59-2704	334	59-2816	338	60-1031	347	61-1130	38	64-202WM	207	64-403W	207	64-831WM	207		
59-2705	334	59-2817	338	60-1032	347	61-1131	38	64-203GM	207	64-404G	207	64-832GM	207		
59-2706	334	59-2820	338	60-1035	347	61-1132	38	64-203WM	207	64-404W	207	64-832WM	207		
59-2707	334	59-2821	338	60-1036	345	61-1211	35	64-204GM	207	64-405G	207	64-841G	207		
59-2708	334	59-2822	338	60-1041	347	61-1212	35	64-204WM	207	64-405W	207	64-841W	207		
59-2709	334	59-2830	337	60-1042	347	61-1213	35	64-205GM	207	64-501G	207	64-842G	207		
59-2710	334	59-2835	337	60-1043	347	61-1221	35	64-205WM	207	64-501W	207	64-842W	207		
59-2711	334	59-2845	337	60-1045	347	61-1222	36	64-206GM	207	64-502G	207	64-843G	207		
59-2712	334	59-2850	337	60-1046	347	61-1231	36	64-206WM	207	64-502W	207	64-843W	207		
59-2713	334	59-2880	337	60-1047	347	61-1232	36	64-207GM	207	64-503G	207	64-844G	207		
59-2714	334	59-2885	336	60-1048	347	61-1233	36	64-207WM	207	64-503W	207	64-844W	207		
59-2715	334	59-2886	337	60-1049	347	61-1234	36	64-208GM	207	64-504G	207	64-845G	207		
59-2716	334	59-2887	338	60-1050	345	61-1235	36	64-208WM	207	64-504W	207	64-845W	207		
59-2717	334	59-2890	336	61		61-1236	36	64-209GM	207	64-505G	207	64-846G	207		
59-2718	334	59-2891	336	61-1011	32	61-1237	36	64-209WM	207	64-505W	207	64-846W	207		
59-2719	334	59-2895	337	61-1012	32	61-1238	128	64-210WM	207	64-506G	207	64-847G	207		
59-2720	334	59-2897	335	61-1013	32	61-1251	36	64-211GM	207	64-506W	207	64-847W	207		
59-2750	335	59-2898	335	61-1014	32	61-1252	36	64-211WM	207	64-507G	207	64-848G	207		
59-2751	335	59-2899	335	61-1015	32	61-1253	37	64-212GM	207	64-507W	207	64-848W	207		
59-2752	335	59-2920	336	61-1016	32	61-1254	37	64-212WM	207	64-508G	207	64-849G	207		
59-2753	335	59-2945	338	61-1017	32	61-1255	37	64-213GM	207	64-508W	207	64-849W	207		
59-2755	335	59-2946	338	61-1018	32	61-1256	37	64-213WM	207	64-509G	207	64-850G	207		
59-2756	335	59-2947	338	61-1019	32	61-1257	37	64-214GM	207	64-509W	207	64-850W	207		
59-2757	335	59-2948	338	61-1020	32	61-1259	37	64-214WM	207	64-601G	207	64-851G	207		
59-2760	335	59-2951	338	61-1021	32	61-1261	37	64-215GM	207	64-601W	207	64-851W	207		
59-2761	335	59-2952	338	61-1031	33	61-1262	37	64-215WM	207	64-602G	207	64-852G	207		
59-2762	335	59-2955	338	61-1032	33	61-1263	37	64-216GM	207	64-602W	207	64-852W	207		
59-2765	335	59-2956	338	61-1033	33	61-1264	37	64-216WM	207	64-603G	207	64-853G	207		
59-2766	335	59-2957	338	61-1034	33	61-1265	37	64-217GM	207	64-603W	207	65-210GM	207		
59-2767	335	59-2958	338	61-1035	33	64		64-217WM	207	64-604G	207				
59-2770	335	59-3100	339	61-1041	33	64-001G	207	64-301G	207	64-604W	207				

OLD # TO NEW



OLD #	NEW #	PG#	OLD #	NEW #	PG#	OLD #	NEW #	PG#	OLD #	NEW #	PG#	OLD #	NEW #	PG#	OLD #	NEW #	PG#
AC-008	21-1778	10	AC-036-24	21-1884	11	AC-112	21-1946	11	AS-125	21-2371	18	AT-025-03	21-2868	25	AT-064-21	21-2463	19
AC-009	21-1779	10	AC-037	21-1925	11	AC-113	21-1947	11	AS-126	21-2374	18	AT-025-06	21-2841	26	AT-064-22	21-2466	19
AC-010	21-1780	10	AC-038	21-1926	11	AC-114	21-1948	11	AS-127	21-2377	18	AT-025-07	21-2842	26	AT-064-24	21-2469	19
AC-011	21-1781	10	AC-038-01	21-1921	11	AC-115	21-1949	11	AS-128	21-2380	18	AT-026	21-2801	25	AT-064-25	21-2473	19
AC-012	21-1782	10	AC-038-02	21-1922	11	AC-116	21-1950	11	AS-129	21-2386	18	AT-027	21-2808	25	AT-064-26	21-2481	19
AC-013	21-1783	10	AC-038-03	21-1927	11	AC-117	21-1951	11	AS-130	21-2372	18	AT-028	21-2810	25	AT-064-27	21-2483	19
AC-014	21-1784	10	AC-039	21-2011	12	AC-118	21-1952	11	AS-131	21-2375	18	AT-029	21-2812	25	AT-064-28	21-2485	19
AC-015	21-1785	10	AC-040	21-2012	12	AC-119	21-1953	11	AS-132	21-2378	18	AT-030	21-2807	25	AT-064-30	21-2487	19
AC-016	21-1786	10	AC-041	21-2016	12	AC-120	21-1954	11	AS-133	21-2381	18	AT-031	21-2809	25	AT-064-31	21-2491	19
AC-017	21-1787	10	AC-042	21-2017	12	AC-121	21-1955	11	AS-134	21-2387	18	AT-032	21-2811	25	AT-064-32	21-2492	19
AC-018	21-1788	10	AC-043	21-2018	12	AC-122	21-1956	11	AS-136	21-2373	18	AT-033	21-2815	25	AT-064-33	21-2493	19
AC-019	21-1789	10	AC-044	21-2019	12	AC-123	21-1957	11	AS-137	21-2376	18	AT-033-01	21-2816	25	AT-065	21-2162	15
AC-020	21-1790	10	AC-045	21-2021	12	AC-124	21-1958	11	AS-138	21-2379	18	AT-034	21-2802	25	AT-066	21-2161	15
AC-021	21-1791	10	AC-046	21-2022	12	AC-125	21-1959	11	AS-139	21-2382	18	AT-035	21-2871	25	AT-067	21-2163	15
AC-022	21-1792	10	AC-047	21-2031	12	AC-126	21-1960	11	AS-140	21-2388	18	AT-035-05	21-2874	25	AT-068	21-2164	15
AC-023	21-1793	10	AC-048	21-2032	12	AC-127	21-1961	11	AS-150	21-2679	22	AT-035-10	21-2877	25	AT-069	21-2391	18
AC-024	21-1794	10	AC-049	21-2033	12	AC-128	21-1962	11	AS-151	21-2678	22	AT-035-11	21-2878	25	AT-070	21-2211	16
AC-025	21-1801	10	AC-051	21-2034	12	AN-001	38-1071	186	AS-152	21-2677	22	AT-036	21-2891	26	AT-070-01	21-2212	16
AC-026	21-1802	10	AC-052	21-2041	12	AN-004	38-1072	186	AS-153	21-2676	22	AT-037	21-2892	26	AT-070-02	21-2213	16
AC-027	21-1803	10	AC-053	21-2042	12	AN-010	38-1073	186	AS-154	21-2675	22	AT-040	21-2351	18	AT-070-04	21-2214	16
AC-028	21-1804	10	AC-054	21-2043	12	AN-019	38-1074	186	AS-155	21-2674	22	AT-041	21-2354	18	AT-070-05	21-2215	16
AC-029	21-1805	10	AC-055	21-2044	12	AN-035	38-1091	186	AS-156	21-2673	22	AT-042	21-2357	18	AT-070-06	21-2216	16
AC-030	21-1806	10	AC-056	21-2051	12	AN-039	38-1094	186	AS-157	21-2672	22	AT-043	21-2360	18	AT-070-07	21-2217	16
AC-031	21-1807	10	AC-057	21-2052	12	AN-040	38-1095	186	AS-158	21-2671	22	AT-045	21-2352	18	AT-070-08	21-2218	16
AC-032	21-1808	10	AC-058	21-2053	12	AN-041	38-1092	186	AS-160	21-2680	22	AT-045-01	21-2355	18	AT-070-09	21-2219	16
AC-032-01	21-1809	10	AC-059	21-2061	12	AN-042	38-1093	186	AS-701	25-1096	60	AT-045-02	21-2358	18	AT-072	21-2166	15
AC-032-02	21-1810	10	AC-061	21-1831	10	AN-043	38-1096	186	AS-702	25-1097	60	AT-045-03	21-2361	18	AT-073	21-2165	15
AC-032-03	21-1811	10	AC-062	21-1832	10	AN-083-01	38-1081	186	AS-703	25-1098	60	AT-047	21-2353	18	AT-074	21-2167	15
AC-032-04	21-1812	10	AC-063	21-1833	10	AN-083-02	38-1082	186	AS-721	25-1413	60	AT-048	21-2356	18	AT-075	21-2168	15
AC-032-05	21-1813	10	AC-064	21-1834	10	AN-083-03	38-1083	186	AS-721-01	25-1416	60	AT-049	21-2359	18	AT-076	21-2173	15
AC-032-06	21-1814	10	AC-065	21-1835	10	AN-083-04	38-1084	186	AS-722	25-1412	60	AT-050	21-2362	18	AT-077	21-2172	15
AC-032-07	21-1815	10	AC-066	21-1836	10	AN-106	38-1080	186	AS-722-01	25-1415	60	AT-053	21-2852	25	AT-078	21-2171	15
AC-032-08	21-1816	10	AC-067	21-1837	10	AN-371	23-1015	40	AS-723	25-1414	60	AT-054	21-2851	25	AT-079	21-2174	15
AC-032-09	21-1817	10	AC-068	21-1838	10	AN-373	29-1018	110	AS-723-01	25-1411	60	AT-055	21-2854	25	AT-080	21-2103	14
AC-032-10	21-1818	10	AC-071	21-1841	10	AN-374	29-1019	110	AS-725	24-1415	55	AT-056	21-2853	25	AT-081	21-2102	14
AC-032-11	21-1819	10	AC-072	21-1842	10	AN-390	23-1011	40	AS-726	24-1414	55	AT-057	21-2859	25	AT-082	21-2101	14
AC-032-12	21-1820	10	AC-073	21-1843	10	AN-392	23-1012	40	AS-727	24-1413	55	AT-058	21-2858	25	AT-083	21-2104	14
AC-033	21-1899	11	AC-074	21-1844	10	AN-401	23-1023	40	AS-728	24-1412	55	AT-059	21-2207	15	AT-084	21-2107	14
AC-034	21-1900	11	AC-075	21-1845	10	AN-402	23-1021	40	AS-730	24-1424	55	AT-060	21-2150	14	AT-085	21-2106	14
AC-035	21-1901	11	AC-076	21-1846	10	AN-403	23-1025	40	AS-731	24-1423	55	AT-061	21-2149	14	AT-086	21-2105	14
AC-036	21-1902	11	AC-077	21-1847	10	AN-404	23-1022	40	AS-732	24-1422	55	AT-062	21-2151	14	AT-087	21-2108	14
AC-036-01	21-1903	11	AC-078	21-1848	10	AN-405	23-1035	40	AS-733	24-1435	55	AT-063	21-2152	14	AT-088	21-2111	14
AC-036-02	21-1904	11	AC-079	21-1849	10	AN-406	23-1027	40	AS-734	24-1434	55	AT-063-02	21-2146	14	AT-089	21-2110	14
AC-036-03	21-1905	11	AC-080	21-1850	10	AN-407	23-1028	40	AS-735	24-1433	55	AT-063-03	21-2145	14	AT-090	21-2109	14
AC-036-04	21-1906	11	AC-081	21-1851	10	AN-408	23-1057	42	AS-736	24-1432	55	AT-063-04	21-2147	14	AT-091	21-2112	14
AC-036-05	21-1907	11	AC-082	21-1852	10	AN-409	23-1031	40	AT-004	21-2821	26	AT-063-05	21-2148	14	AT-092	21-2115	14
AC-036-06	21-1908	11	AC-083	21-1853	10	AN-412	23-1032	41	AT-006	21-2823	26	AT-064	21-2441	19	AT-093	21-2114	14
AC-036-07	21-1909	11	AC-084	21-1854	10	AN-413	23-1033	41	AT-008	21-2825	26	AT-064-01	21-2443	19	AT-094	21-2113	14
AC-036-08	21-1910	11	AC-085	21-1855	10	AN-414	23-1034	41	AT-014	21-2822	26	AT-064-02	21-2445	19	AT-095	21-2116	14
AC-036-09	21-1911	11	AC-086	21-1856	10	AN-415	23-1036	40	AT-016	21-2824	26	AT-064-03	21-2447	19	AT-097	21-2292	17
AC-036-10	21-1912	11	AC-091	21-1873	10	AN-416	23-1037	41	AT-018	21-2826	26	AT-064-04	21-2451	19	AT-098	21-2294	17
AC-036-11	21-1913	11	AC-092	21-1875	10	AN-417	23-1273	233	AT-020	21-2831	26	AT-064-06	21-2442	19	AT-099	21-2293	17
AC-036-12	21-1914	11	AC-093	21-1878	10	AN-418	23-1038	41	AT-021	21-2832	26	AT-064-07	21-2444	19	AT-100	21-2291	17
AC-036-13	21-1891	11	AC-101	21-1931	11	AS-010	42-1121	226	AT-021-01	21-2835	26	AT-064-08	21-2446	19	AT-101	21-2122	14
AC-036-14	21-1892	11	AC-102	21-1932	11	AS-110	21-2310	17	AT-021-02	21-2836	26	AT-064-09	21-2448	19	AT-102	21-2126	14
AC-036-15	21-1893	11	AC-103	21-1933	11	AS-110-01	21-2301	17	AT-021-03	21-2837	26	AT-064-10	21-2452	19	AT-103	21-2142	14
AC-036-16	21-1894	11	AC-104	21-1934	11	AS-110-02	21-2302	17	AT-021-04	21-2838	26	AT-064-12	21-2461	19	AT-104	21-2154	14
AC-036-17	21-1895	11	AC-105	21-1935	11	AS-110-03	21-2303	17	AT-021-05	21-2839	26	AT-064-13	21-2464	19	AT-105	21-2130	14
AC-036-18	21-1896	11	AC-106	21-1936	11	AS-110-04	21-2304	17	AT-022	21-2861	25	AT-064-14	21-2467	19	AT-106	21-2134	14
AC-036-19	21-1897	11	AC-107	21-1937	11	AS-110-05	21-2305	17	AT-023	21-2862	25	AT-064-15	21-2471	19	AT-107	21-2121	14
AC-036-20	21-1898	11	AC-108	21-1938	11	AS-110-06	21-2306	17	AT-024	21-2863	25	AT-064-16	21-2462	19	AT-108	21-2125	14
AC-036-21	21-1881	11	AC-109	21-1943	11	AS-110-07	21-2307	17	AT-025	21-2864	25	AT-064-18	21-2465	19	AT-109	21-2129	14
AC-036-22	21-1882	11	AC-110	21-1944	11	AS-110-08	21-2308	17	AT-025-01	21-2866	25	AT-064-19	21-2468	19	AT-110	21-2133	14
AC-036-23	21-1883	11	AC-111	21-1945	11	AS-110-09	21-2309	17	AT-025-02	21-2867	25	AT-064-20	21-2472	19	AT-111	21-2141	14



OLD # TO NEW#

OLD #	NEW #	PG#	OLD #	NEW #	PG#	OLD #	NEW #	PG#	OLD #	NEW #	PG#	OLD #	NEW #	PG#	OLD #	NEW #	PG#
AT-112	21-2153	14	AT-144-13	21-2259	16	AT-165	21-2611	21	AT-200-05	21-2701	24	AT-269-01	21-1102	6	AT-340-08	21-1581	3
AT-114	21-2124	14	AT-144-17	21-2262	17	AT-166	21-2635	21	AT-201	21-2731	24	AT-269-02	21-1103	6	AT-340-09	21-1582	3
AT-115	21-2128	14	AT-144-18	21-2263	17	AT-166-01	21-2634	21	AT-203	21-1241	6	AT-269-03	21-1104	6	AT-340-10	21-1583	3
AT-116	21-2144	14	AT-144-21	21-2265	17	AT-166-02	21-2633	21	AT-204	21-1242	6	AT-269-04	21-1105	6	AT-340-11	21-1584	3
AT-117	21-2156	14	AT-144-22	21-2266	17	AT-166-03	21-2632	21	AT-205	21-1243	6	AT-270	21-2091	13	AT-342	21-1201	3
AT-118	21-2132	14	AT-144-25	21-2268	17	AT-166-04	21-2631	21	AT-206	21-1244	6	AT-271	21-2092	13	AT-343	21-1202	3
AT-119	21-2136	14	AT-144-26	21-2269	17	AT-166-05	21-2630	21	AT-208	21-1245	6	AT-272	21-2095	13	AT-344	21-1203	3
AT-121	21-2123	14	AT-144-32	21-2272	17	AT-166-06	21-2629	21	AT-209	21-1451	8	AT-273	21-2096	13	AT-348	21-1204	3
AT-122	21-2127	14	AT-144-33	21-2273	17	AT-166-07	21-2628	21	AT-210	21-1452	8	AT-275	21-1011	2	AT-350	21-1211	4
AT-123	21-2131	14	AT-144-36	21-2275	17	AT-166-08	21-2627	21	AT-211	21-1453	8	AT-276	21-1012	2	AT-351	21-1212	4
AT-124	21-2135	14	AT-144-37	21-2276	17	AT-166-09	21-2626	21	AT-212	21-1454	8	AT-277	21-1013	2	AT-352	21-1213	4
AT-125	21-2143	14	AT-144-40	21-2278	17	AT-166-10	21-2625	21	AT-213	21-1455	8	AT-278	21-1014	2	AT-353	21-1214	4
AT-126	21-2155	14	AT-144-41	21-2279	17	AT-166-11	21-2624	21	AT-215	21-1503	9	AT-279	21-1015	2	AT-360	21-1206	3
AT-129	21-2186	15	AT-144-44	21-2281	17	AT-166-12	21-2623	21	AT-216	21-1502	9	AT-280	21-1016	2	AT-362	21-1207	3
AT-130	21-2189	15	AT-144-45	21-2282	17	AT-166-13	21-2622	21	AT-217	21-1501	9	AT-281	21-1017	2	AT-363	21-1208	3
AT-131	21-2190	15	AT-145	21-2751	23	AT-166-14	21-2621	21	AT-218	21-1530	9	AT-282	21-1018	2	AT-367	21-1209	3
AT-131-01	21-2187	15	AT-145-01	21-2752	23	AT-166-20	21-2685	21	AT-219	21-1529	9	AT-283	21-1019	2	AT-370	21-1216	4
AT-131-02	21-2188	15	AT-145-02	21-2761	23	AT-167	21-1091	6	AT-220	21-1528	9	AT-284	21-1020	2	AT-371	21-1217	4
AT-131-04	21-2181	15	AT-145-03	21-2762	23	AT-168	21-1092	6	AT-221	21-1506	9	AT-285	21-1021	2	AT-372	21-1218	4
AT-131-05	21-2184	15	AT-145-04	21-2754	23	AT-169	21-1093	6	AT-222	21-1505	9	AT-290	21-1051	2	AT-373	21-1219	4
AT-131-06	21-2185	15	AT-145-05	21-2764	23	AT-170	21-1094	6	AT-223	21-1504	9	AT-291	21-1052	2	AT-400-01	21-1741	7
AT-131-07	21-2182	15	AT-145-06	21-2757	23	AT-171	21-1095	6	AT-225	21-1512	9	AT-292	21-1053	2	AT-400-02	21-1742	7
AT-131-09	21-2183	15	AT-147	21-1631	4	AT-172	21-1096	6	AT-226	21-1511	9	AT-293	21-1054	2	AT-400-03	21-1743	7
AT-132	21-2201	15	AT-147-01	21-1632	4	AT-173	21-1097	6	AT-227	21-1510	9	AT-294	21-1055	2	AT-400-04	21-1744	7
AT-133	21-2202	15	AT-147-02	21-1633	4	AT-174	21-1238	6	AT-228	21-1509	9	AT-295	21-1056	2	AT-400-05	21-1745	7
AT-134	21-2203	15	AT-147-03	21-1634	4	AT-175	21-1237	6	AT-229	21-1508	9	AT-297	21-1031	2	AT-404-01	21-1751	7
AT-135	21-2204	15	AT-147-05	21-1635	4	AT-176	21-1236	6	AT-230	21-1507	9	AT-298	21-1032	2	AT-404-02	21-1752	7
AT-136	21-2206	15	AT-147-06	21-1636	4	AT-177	21-1235	6	AT-231	21-1536	9	AT-299	21-1033	2	AT-404-04	21-1753	7
AT-137	21-2205	15	AT-147-07	21-1637	4	AT-178	21-1234	6	AT-232	21-1535	9	AT-301	21-1034	2	AT-406-01	21-1755	7
AT-138	21-2221	16	AT-147-08	21-1638	4	AT-179	21-1233	6	AT-233	21-1534	9	AT-302	21-1035	2	AT-406-02	21-1756	7
AT-138-01	21-2222	16	AT-147-10	21-1641	4	AT-180	21-1232	6	AT-235	21-1556	9	AT-316	21-2402	19	AT-406-03	21-1757	7
AT-138-02	21-2223	16	AT-147-11	21-1642	4	AT-180-01	21-1231	6	AT-236	21-1555	9	AT-317	21-2405	19	AT-406-04	21-1758	7
AT-138-03	21-2224	16	AT-147-12	21-1643	4	AT-180-02	21-1221	4	AT-237	21-1554	9	AT-318	21-2408	19	AT-408-01	21-1746	7
AT-139	21-2225	16	AT-147-13	21-1644	4	AT-180-03	21-1222	4	AT-238	21-1553	9	AT-319	21-2411	19	AT-408-02	21-1747	7
AT-139-01	21-2226	16	AT-147-15	21-1645	4	AT-180-04	21-1223	4	AT-239	21-1552	9	AT-320	21-2401	19	AT-408-03	21-1748	7
AT-139-02	21-2227	16	AT-147-16	21-1646	4	AT-180-05	21-1224	4	AT-240	21-1551	9	AT-321	21-2404	19	AT-408-04	21-1749	7
AT-139-03	21-2228	16	AT-147-17	21-1647	4	AT-181	21-2741	23	AT-250	21-1041	2	AT-322	21-2407	19	AT-410-01	21-1761	7
AT-140	21-2229	16	AT-147-18	21-1648	4	AT-182	21-2098	13	AT-251	21-1042	2	AT-323	21-2410	19	AT-410-02	21-1762	7
AT-140-01	21-2230	16	AT-149	21-2071	13	AT-183	21-2742	23	AT-252	21-1043	2	AT-333	21-2403	19	AT-410-04	21-1763	7
AT-140-02	21-2231	16	AT-149-01	21-2072	13	AT-184	21-2712	24	AT-253	21-1301	2	AT-334	21-2406	19	AT-410-05	21-1764	7
AT-140-03	21-2232	16	AT-149-02	21-2073	13	AT-184-01	21-2711	24	AT-253-01	21-1302	2	AT-335	21-2409	19	AT-410-06	21-1765	7
AT-141	21-2236	16	AT-149-03	21-2074	13	AT-185	21-2714	24	AT-253-02	21-1303	2	AT-336	21-2412	19	AT-420	21-1601	22
AT-141-01	21-2237	16	AT-149-04	21-2076	13	AT-186	21-2641	13	AT-254	21-1321	3	AT-337	21-1560	3	AT-420-01	21-1602	22
AT-141-02	21-2238	16	AT-149-05	21-2077	13	AT-187	21-2642	13	AT-254-01	21-1322	3	AT-337	21-2421	18	AT-421	21-1603	22
AT-141-03	21-2239	16	AT-149-06	21-2078	13	AT-188	21-2657	13	AT-254-02	21-1323	3	AT-337-01	21-2422	18	AT-425	21-1604	22
AT-142	21-2240	16	AT-149-07	21-2079	13	AT-189	21-2658	13	AT-254-03	21-1324	3	AT-337-02	21-2423	18	AT-425-01	21-1605	22
AT-142-01	21-2241	16	AT-157	21-2727	23	AT-190	21-2097	13	AT-254-14	21-1311	2	AT-338	21-1561	3	AT-425-02	21-1606	22
AT-142-02	21-2242	16	AT-158	21-2728	23	AT-191	21-2656	13	AT-254-15	21-1312	2	AT-338-01	21-1562	3	AT-425-03	21-1607	22
AT-142-03	21-2243	16	AT-159	21-2721	24	AT-192	21-2651	13	AT-254-16	21-1313	2	AT-338-02	21-1563	3	AT-425-04	21-1608	22
AT-143	21-2244	16	AT-160	21-2722	24	AT-193	21-2652	13	AT-255	21-1341	6	AT-338-03	21-1564	3	AT-426	21-1611	22
AT-143-01	21-2245	16	AT-161	21-2610	21	AT-194	21-2661	13	AT-256	21-1342	6	AT-338-04	21-1565	3	AT-426-01	21-1612	22
AT-143-02	21-2246	16	AT-161-01	21-2613	21	AT-194-01	21-2662	13	AT-257	21-1343	6	AT-338-05	21-1566	3	AT-426-02	21-1613	22
AT-143-03	21-2247	16	AT-161-02	21-2607	21	AT-195	21-2732	23	AT-258	21-2775	23	AT-339	21-1567	3	AT-426-03	21-1614	22
AT-144	21-2248	16	AT-161-03	21-2604	21	AT-195-01	21-2733	23	AT-259	21-2776	23	AT-339-01	21-1568	3	AT-427	21-1617	22
AT-144-01	21-2249	16	AT-161-04	21-2601	21	AT-196	21-2725	24	AT-260	21-2086	13	AT-339-02	21-1569	3	AT-427-01	21-1618	22
AT-144-02	21-2250	16	AT-162	21-2609	21	AT-196-01	21-2726	24	AT-261	21-2085	13	AT-339-03	21-1570	3	AT-427-02	21-1619	22
AT-144-03	21-2251	16	AT-162-01	21-2615	21	AT-197	21-2716	24	AT-262	21-2084	13	AT-340	21-1571	3	AT-427-03	21-1620	22
AT-144-05	21-2252	16	AT-162-02	21-2606	21	AT-197-01	21-2717	24	AT-263	21-2083	13	AT-340-01	21-1572	3	AT-427-04	21-1621	22
AT-144-06	21-2253	16	AT-162-03	21-2603	21	AT-197-02	21-2718	24	AT-264	21-2082	13	AT-340-02	21-1573	3	AT-427-05	21-1622	22
AT-144-07	21-2254	16	AT-163	21-2608	21	AT-198	21-2719	24	AT-265	21-2081	13	AT-340-03	21-1574	3	AT-427-06	21-1623	22
AT-144-08	21-2255	16	AT-163-01	21-2614	21	AT-199	21-2702	24	AT-266	21-1083	6	AT-340-04	21-1575	3	AT-450	21-1661	5
AT-144-10	21-2256	16	AT-163-02	21-2605	21	AT-200	21-2705	24	AT-267	21-1082	6	AT-340-05	21-1576	3	AT-451	21-1662	5
AT-144-11	21-2257	16	AT-163-03	21-2602	21	AT-200-01	21-2706	24	AT-268	21-1081	6	AT-340-06	21-1577	3	AT-452	21-1663	5
AT-144-12	21-2258	16	AT-164	21-2612	21	AT-200-02	21-2709	24	AT-269	21-1101	6	AT-340-07	21-1578	3	AT-453	21-1664	5

OLD # TO NEW



OLD #	NEW #	PG#	OLD #	NEW #	PG#	OLD #	NEW #	PG#	OLD #	NEW #	PG#	OLD #	NEW #	PG#	OLD #	NEW #	PG#
AT-454	21-1665	5	AT-551	21-1472	8	AT-612-02	21-2573	20	AW-030	30-2641	130	BA-362	58-1362	324	BE-014-01	60-1042	347
AT-455	21-1666	5	AT-552	21-1471	8	AT-612-03	21-2574	20	AW-031	30-2642	130	BA-364	58-1364	324	BE-015	60-1031	347
AT-456	21-1667	5	AT-553	21-1470	8	AT-614	21-2581	20	AW-090	30-1411	129	BA-365	58-1365	324	BE-016	60-1014	346
AT-457	21-1668	5	AT-554	21-1469	8	AT-614-01	21-2582	20	AW-120	30-1412	129	BA-366	58-1366	324	BE-017	60-1032	347
AT-458	21-1669	5	AT-555	21-1468	8	AT-614-02	21-2583	20	AW-130	30-1413	129	BA-371	58-1371	324	BE-018	60-1035	347
AT-459	21-1670	5	AT-556	21-1467	8	AT-614-03	21-2584	20	AW-140	30-1414	129	BA-373	58-1373	324	BE-019	23-1312	48
AT-460	21-1671	5	AT-557	21-1466	8	AT-616	21-2591	20	AW-150	30-1415	129	BA-377	58-1377	324	BE-020	23-1311	48
AT-461	21-1672	5	AT-558	21-1465	8	AT-616-01	21-2592	20	AW-160	30-1416	129	BA-379	58-1379	324	BE-020-01	23-1313	48
AT-462	21-1673	5	AT-559	21-1464	8	AT-618	21-2596	20	AW-180	30-1417	129	BA-381	58-1381	324	BE-020-02	23-1314	48
AT-463	21-1674	5	AT-560	21-1463	8	AT-618-01	21-2597	20	AW-319	30-1401	129	BA-386	58-1386	324	BE-020-03	23-1361	49
AT-467	21-1681	5	AT-561	21-1462	8	AT-621	21-2531	21	AW-320	30-1402	129	BA-387	58-1387	324	BE-020-04	23-1362	49
AT-468	21-1682	5	AT-562	21-1461	8	AT-621-01	21-2532	21	AW-323	30-1403	129	BA-390	58-1390	324	BE-020-05	43-1084	234
AT-469	21-1683	5	AT-563	21-1442	8	AT-621-02	21-2533	21	AW-324	30-1404	129	BA-391	58-1391	324	BE-022	23-1317	48
AT-470	21-1684	5	AT-564	21-1441	8	AT-622	21-2534	21	AW-325	30-1405	129	BA-392	58-1392	324	BE-023	23-1318	48
AT-471	21-1685	5	AT-565	21-1440	8	AT-622-01	21-2535	21	AW-326	30-1406	129	BA-393	58-1393	324	BE-024	23-1319	48
AT-472	21-1686	5	AT-566	21-1439	8	AT-622-02	21-2536	21	AW-327	30-1407	129	BA-394	58-1394	324	BE-025	23-1320	48
AT-473	21-1687	5	AT-567	21-1438	8	AT-623	21-2537	21	AW-328	30-1421	129	BA-395	58-1395	324	BE-026	23-1321	48
AT-474	21-1688	5	AT-568	21-1437	8	AT-623-01	21-2538	21	AW-329	30-1422	129	BA-397	58-1397	324	BE-027	23-1322	48
AT-475	21-1689	5	AT-569	21-1436	8	AT-623-02	21-2539	21	AW-330	30-1424	129	BD-621	49-1143	264	BE-028	23-1323	48
AT-476	21-1690	5	AT-570	21-1435	8	AT-624	21-2540	21	AW-335	30-1425	129	BD-622	49-1141	264	BE-029	23-1324	48
AT-479	21-1654	4	AT-571	21-1434	8	AT-624-01	21-2541	21	AW-340	30-1426	129	BD-623	49-1142	264	BE-029-01	23-1325	48
AT-480	21-1653	4	AT-572	21-1433	8	AT-624-02	21-2542	21	AW-345	30-1427	129	BD-624	49-1144	264	BE-030	23-1326	48
AT-481	21-1652	4	AT-573	21-1432	8	AT-625	21-2546	21	AW-350	30-1428	129	BD-625	49-1145	264	BE-031	23-1327	48
AT-482	21-1651	4	AT-574	21-1431	8	AT-625-01	21-2547	21	AW-355	30-1429	129	BD-628	49-1131	264	BE-032	23-1328	48
AT-487	21-1701	5	AT-580	21-1483	8	AT-625-02	21-2548	21	AW-360	30-1430	129	BD-629	49-1132	264	BE-032-01	23-1329	48
AT-488	21-1702	5	AT-581	21-1482	8	AT-631	21-2551	21	AW-365	30-1431	129	BD-630	49-1135	264	BE-033	23-1331	49
AT-490	21-1703	5	AT-582	21-1481	8	AT-631-01	21-2552	21	AW-366	30-1423	129	BD-631	49-1136	264	BE-033-01	23-1332	49
AT-491	21-1704	5	AT-586	21-1486	8	AT-631-02	21-2553	21	AW-380	30-1432	129	BD-700	49-1100	264	BE-034	23-1333	48
AT-492	21-1705	5	AT-587	21-1485	8	AT-632	21-2554	21	BA-020	58-1514	324	BD-701	49-1101	264	BE-035	23-1334	48
AT-493	21-1706	5	AT-588	21-1484	8	AT-632-01	21-2555	21	BA-021	58-1515	324	BD-702	49-1102	264	BE-036	23-1335	48
AT-494	21-1707	5	AT-601	21-2501	20	AT-632-02	21-2556	21	BA-030	58-1502	323	BD-703	49-1103	264	BE-037	43-1081	234
AT-495	21-1708	5	AT-601-01	21-2502	20	AT-633	21-2557	21	BA-031	58-1504	323	BD-704	49-1104	264	BE-038	32-1269	143
AT-497	21-1709	5	AT-601-02	21-2503	20	AT-633-01	21-2558	21	BA-040	58-1512	323	BD-705	49-1105	264	BE-040	43-1085	234
AT-498	21-1710	5	AT-601-03	21-2504	20	AT-633-02	21-2559	21	BA-042	58-1510	323	BD-706	49-1106	264	BE-041	23-1344	49
AT-499	21-1711	5	AT-601-04	21-2505	20	AT-657	21-1533	9	BA-044	58-1508	323	BD-707	49-1107	264	BE-042	23-1342	49
AT-500	21-1712	5	AT-601-05	21-2506	20	AT-658	21-1532	9	BA-046	58-1506	323	BD-708	49-1108	264	BE-042-01	23-1341	49
AT-501	21-1718	5	AT-601-06	21-2507	20	AT-659	21-1531	9	BA-047	58-1507	323	BD-709	49-1109	264	BE-043	23-1343	49
AT-502	21-1720	5	AT-601-07	21-2508	20	AT-666	21-1527	9	BA-102-05	58-1401	324	BD-710	49-1110	264	BE-100	23-1151	44
AT-503	21-1721	5	AT-601-08	21-2509	20	AT-667	21-1526	9	BA-121-06	58-1402	324	BD-711	49-1111	264	BE-101	23-1152	44
AT-504	21-1722	5	AT-601-09	21-2510	20	AT-668	21-1525	9	BA-122	58-1403	324	BD-712	49-1112	264	BF-001	25-1621	60
AT-505	21-1723	5	AT-601-10	21-2511	20	AT-669	21-1518	9	BA-122-05	58-1404	324	BD-713	49-1113	264	BF-002	25-1622	60
AT-506	21-1724	5	AT-601-11	21-2512	20	AT-670	21-1517	9	BA-161-06	58-1405	324	BD-714	49-1114	264	BF-003	25-1623	60
AT-526	21-2191	15	AT-601-12	21-2513	20	AT-671	21-1516	9	BA-162	58-1406	324	BD-715	49-1115	264	BF-004	25-1611	60
AT-527	21-2192	15	AT-601-13	21-2514	20	AT-672	21-1515	9	BA-163-02	58-1407	324	BD-716	49-1116	264	BF-005	25-1612	60
AT-528	21-2193	15	AT-601-14	21-2515	20	AT-673	21-1514	9	BA-201-02	58-1408	324	BD-717	49-1117	264	BF-006	25-1613	60
AT-529	21-2194	15	AT-601-15	21-2516	20	AT-674	21-1513	9	BA-201-06	58-1409	324	BD-718	49-1118	264	BF-007	25-1614	60
AT-530	21-1404	8	AT-601-16	21-2517	20	AT-675	21-1524	9	BA-202-05	58-1410	324	BD-719	49-1119	264	BF-008	25-1615	60
AT-531	21-1405	8	AT-601-17	21-2518	20	AT-676	21-1523	9	BA-203-02	58-1412	324	BD-720	49-1120	264	BF-010	25-1950	66
AT-532	21-1406	8	AT-601-18	21-2519	20	AT-677	21-1522	9	BA-232	58-1413	324	BD-721	49-1121	264	BF-011	25-1949	66
AT-533	21-1407	8	AT-601-19	21-2520	20	AT-678	21-1521	9	BA-243	58-1414	324	BD-722	49-1122	264	BF-012	25-1948	66
AT-534	21-1408	8	AT-601-20	21-2521	20	AT-679	21-1520	9	BA-245	58-1415	324	BE-002	60-1023	346	BF-013	25-1947	66
AT-535	21-1409	8	AT-601-21	21-2522	20	AT-680	21-1519	9	BA-309	58-1309	324	BE-003	60-1019	346	BF-015	25-1946	66
AT-536	21-1413	8	AT-601-22	21-2523	20	AT-681	21-1548	9	BA-315	58-1315	324	BE-004	60-1021	346	BF-016	25-1945	66
AT-537	21-1412	8	AT-601-23	21-2524	20	AT-682	21-1547	9	BA-317	58-1317	324	BE-005	60-1022	346	BF-017	25-1944	66
AT-538	21-1411	8	AT-601-24	21-2525	20	AT-683	21-1546	9	BA-319	58-1319	324	BE-006	60-1018	345	BF-018	25-1943	66
AT-539	21-1416	8	AT-601-25	21-2526	20	AT-684	21-1545	9	BA-321	58-1321	324	BE-007	60-1020	345	BF-019	25-1938	66
AT-540	21-1415	8	AT-601-26	21-2527	20	AT-685	21-1544	9	BA-329	58-1329	324	BE-008	60-1012	345	BF-020	25-1937	66
AT-541	21-1414	8	AT-601-27	21-2528	20	AT-686	21-1543	9	BA-335	58-1335	324	BE-009	60-1011	345	BF-021	25-1936	66
AT-542	21-1419	8	AT-610-02	21-2561	20	AT-687	21-1542	9	BA-337	58-1337	324	BE-010	60-1017	345	BF-022	25-1935	66
AT-543	21-1418	8	AT-610-03	21-2562	20	AT-688	21-1541	9	BA-339	58-1339	324	BE-010-01	60-1036	345	BF-023	25-1942	66
AT-544	21-1417	8	AT-610-06	21-2563	20	AT-689	21-1540	9	BA-341	58-1341	324	BE-011	60-1013	345	BF-025	25-1934	66
AT-545	21-1422	8	AT-610-07	21-2564	20	AT-690	21-1539	9	BA-344	58-1344	324	BE-012	60-1015	346	BF-026	25-1933	66
AT-546	21-1421	8	AT-612	21-2571	20	AT-691	21-1538	9	BA-346	58-1346	324	BE-013	60-1016	346	BF-027	25-1932	66
AT-547	21-1420	8	AT-612-01	21-2572	20	AT-692	21-1537	9	BA-357	58-1357	324	BE-014	60-1041	347	BF-028	25-1931	66



OLD # TO NEW#

OLD #	NEW #	PG#	OLD #	NEW #	PG#	OLD #	NEW #	PG#	OLD #	NEW #	PG#	OLD #	NEW #	PG#	OLD #	NEW #	PG#
BF-030	25-1914	66	BF-133	25-1746	65	BF-352	42-1252	228	BF-422	25-1252	61	BF-490-03	25-1382	62	BK-413	61-1115	35
BF-030-01	25-1913	66	BF-134	25-1747	65	BF-353	42-1256	228	BF-423	25-1253	61	BF-490-04	25-1388	62	BK-414	61-1072	34
BF-030-02	25-1912	66	BF-135	25-1748	65	BF-354	42-1257	228	BF-424	25-1254	61	BF-491	25-1383	62	BK-415	61-1061	34
BF-030-03	25-1911	66	BF-136	25-1749	65	BF-356	25-1101	58	BF-425	25-1255	61	BF-492	25-1389	62	BK-416	61-1073	34
BF-031	25-1918	66	BF-140	25-1751	65	BF-357	25-1102	58	BF-426	25-1256	61	BF-493	25-1384	62	BK-417	61-1222	36
BF-031-01	25-1917	66	BF-141	25-1752	65	BF-358	25-1103	58	BF-431	25-1278	61	BF-494	25-1385	62	BK-418	61-1074	34
BF-031-02	25-1916	66	BF-142	25-1753	65	BF-359	25-1104	58	BF-431-01	25-1288	61	BF-495	25-1386	62	BK-419	61-1062	34
BF-031-03	25-1915	66	BF-143	25-1754	65	BF-360	25-1105	58	BF-432	25-1279	61	BF-500	25-1841	64	BK-420	61-1051	33
BF-032-01	25-1921	66	BF-144	25-1755	65	BF-360-01	25-1106	58	BF-432-01	25-1289	61	BF-500-01	25-1842	64	BK-421	61-1052	34
BF-032-02	25-1920	66	BF-145	25-1756	65	BF-360-02	25-1107	58	BF-433	25-1280	61	BF-501	25-1845	64	BK-422	61-1012	32
BF-032-03	25-1919	66	BF-146	25-1757	65	BF-360-03	25-1108	58	BF-433-01	25-1290	61	BF-501-01	25-1846	64	BK-423	61-1259	37
BF-038	25-1904	66	BF-147	25-1761	65	BF-360-04	25-1109	58	BF-434	25-1281	61	BF-502	25-1847	64	BK-424	61-1235	36
BF-039	25-1973	67	BF-147-01	25-1762	65	BF-360-05	25-1110	58	BF-434-01	25-1291	61	BF-502-01	25-1848	64	BK-425	61-1236	36
BF-040	25-1972	67	BF-147-02	25-1763	65	BF-360-06	25-1111	58	BF-435	25-1282	61	BF-502-98	25-1861	64	BK-426	61-1053	34
BF-041	25-1971	67	BF-147-03	25-1764	65	BF-360-07	25-1112	58	BF-435-01	25-1292	61	BF-502-99	25-1871	64	BK-427	61-1013	32
BF-045	25-1951	66	BF-147-05	25-1766	65	BF-361	25-1071	58	BF-436	25-1283	61	BF-503	25-1862	64	BK-428	61-1231	36
BF-045-01	25-1952	66	BF-147-06	25-1767	65	BF-362	25-1072	58	BF-436-01	25-1293	61	BF-503-01	25-1872	64	BK-429	61-1237	36
BF-045-02	25-1953	66	BF-148	25-1771	65	BF-363	25-1073	58	BF-437	25-1284	61	BF-504	25-1863	64	BK-430	61-1234	36
BF-045-03	25-1954	66	BF-149	25-1772	65	BF-364	25-1074	58	BF-437-01	25-1294	61	BF-504-01	25-1873	64	BK-431	61-1232	36
BF-045-04	25-1955	66	BF-150	25-1011	58	BF-366	25-1075	58	BF-438	25-1285	61	BF-504-04	25-1864	64	BK-431-01	61-1233	36
BF-045-05	25-1956	66	BF-152	25-1015	58	BF-367	25-1076	58	BF-438-01	25-1295	61	BF-504-05	25-1874	64	BK-432	61-1075	34
BF-046	25-1961	66	BF-153	25-1014	58	BF-368	25-1077	58	BF-439	25-1286	61	BF-504-07	25-1865	64	BK-433	61-1252	36
BF-046-01	25-1962	66	BF-158-01	25-1023	58	BF-369	25-1078	58	BF-439-01	25-1296	61	BF-504-08	25-1875	64	BK-434	61-1253	37
BF-046-02	25-1963	66	BF-159-01	25-1029	58	BF-381	25-1079	58	BF-440	25-1287	61	BF-505	25-1881	64	BK-435	61-1254	37
BF-046-03	25-1964	66	BF-160	25-1031	58	BF-382	25-1080	58	BF-440-01	25-1297	61	BF-506	25-1882	64	BK-436	61-1014	32
BF-046-04	25-1965	66	BF-160-01	25-1032	58	BF-383	25-1081	58	BF-441	25-1391	63	BF-508	25-1839	64	BK-437	61-1033	33
BF-046-05	25-1966	66	BF-161	25-1034	58	BF-384	25-1082	58	BF-441-01	25-1392	63	BF-510	25-1091	60	BK-438	61-1211	35
BF-048	25-1773	66	BF-161-01	25-1035	58	BF-387-02	25-1117	59	BF-441-02	25-1393	63	BF-511	25-1092	60	BK-439	61-1255	37
BF-048-01	25-1474	66	BF-166	25-1041	58	BF-387-03	25-1118	59	BF-442	25-1811	63	BF-512	25-1093	60	BK-440	61-1257	37
BF-050	25-1977	67	BF-166-02	25-1061	58	BF-387-04	25-1119	59	BF-442-01	25-1812	63	BF-520	25-1131	59	BK-441	61-1261	37
BF-051	25-1978	67	BF-167	25-1042	58	BF-390	25-1433	60	BF-442-02	25-1813	63	BF-521	25-1132	59	BK-441-01	61-1262	37
BF-052	25-1979	67	BF-170	25-1044	58	BF-391	25-1432	60	BF-443	25-1821	63	BF-522	25-1133	59	BK-441-02	61-1263	37
BF-060	25-1988	67	BF-170-02	25-1062	58	BF-392	25-1431	60	BF-443-01	25-1822	63	BF-523	25-1134	59	BK-441-03	61-1264	37
BF-061	25-1984	67	BF-172-01	25-1051	58	BF-393	25-1439	60	BF-443-02	25-1823	63	BF-524	25-1135	59	BK-441-04	61-1265	37
BF-064	25-1986	67	BF-172-02	25-1063	58	BF-394	25-1438	60	BF-444	25-2115	63	BF-530	25-1136	59	BK-442	61-1076	35
BF-067	25-1987	67	BF-173-01	25-1052	58	BF-395	25-1437	60	BF-444-01	25-2116	63	BF-540	25-1885	64	BK-443	61-1034	33
BF-068	25-1982	67	BF-173-02	25-1064	58	BF-402	25-1531	62	BF-453	25-1561	62	BF-543	25-2011	67	BK-445	61-1035	33
BF-069	25-1981	67	BF-174	25-1047	58	BF-403	25-1534	62	BF-454	25-1564	62	BF-544	25-2012	67	BK-446	61-1041	33
BF-100	25-2125	66	BF-174-01	25-1053	58	BF-404	25-1538	62	BF-455	25-1569	62	BF-545	25-2013	67	BK-447	61-1042	33
BF-101	25-2126	66	BF-174-02	25-1065	58	BF-404-01	25-1539	62	BF-456	25-1573	62	BF-546	25-2016	67	BK-448	61-1256	37
BF-102	25-2127	66	BF-176	25-1213	59	BF-404-02	25-1544	62	BF-457	25-1579	62	BF-547	25-2017	67	BK-449	61-1212	35
BF-103	25-2128	66	BF-176-01	25-1221	59	BF-405	25-1545	62	BF-463	25-1581	62	BF-548	25-2018	67	BK-450	61-1043	33
BF-105	25-2121	66	BF-178	25-1214	59	BF-405-01	25-1548	62	BF-464	25-1584	62	BF-550	25-1992	67	BK-451	61-1044	33
BF-106	25-2122	66	BF-178-01	25-1222	59	BF-405-02	25-1550	62	BF-465	25-1589	62	BF-551	25-1993	67	BK-452	61-1063	34
BF-107	25-2123	66	BF-179	25-1215	59	BF-406	25-1551	62	BF-466	25-1595	62	BF-552	25-1991	67	BK-453	61-1213	35
BF-110	25-1721	65	BF-179-01	25-1223	59	BF-406-01	25-1554	62	BF-467	25-1597	62	BF-553	25-1996	67	BK-500	61-1238	128
BF-111	25-1723	65	BF-181	25-1216	59	BF-406-02	25-1556	62	BF-469	25-1271	61	BF-554	25-1997	67	BR-001	26-4010	77
BF-112	25-1724	65	BF-181-01	25-1226	59	BF-407	25-1552	62	BF-470	25-1272	61	BK-302	61-1112	35	BR-002	26-4012	77
BF-113	25-1725	65	BF-182	25-1218	59	BF-413	25-1504	62	BF-471	25-1273	61	BK-303	61-1113	35	BR-003	26-4014	77
BF-114	25-1726	65	BF-182-01	25-1228	59	BF-414	25-1508	62	BF-472	25-1274	61	BK-304	61-1114	35	BR-004	26-4015	77
BF-114-01	25-1727	65	BF-205	25-1231	59	BF-414-01	25-1509	62	BF-473	25-1601	62	BK-334	61-1111	35	BR-005	26-4016	77
BF-115	25-1712	65	BF-205-01	25-1236	59	BF-414-02	25-1514	62	BF-474	25-1602	62	BK-400	61-1251	36	BR-006	26-4018	77
BF-116	25-1713	65	BF-209	25-1232	59	BF-415	25-1515	62	BF-475	25-1603	62	BK-401	61-1015	32	BR-007	26-4021	77
BF-117	25-1714	65	BF-209-01	25-1237	59	BF-415-01	25-1518	62	BF-476	25-1604	62	BK-402	61-1016	32	BR-008	26-4023	77
BF-118	25-1715	65	BF-214	25-1233	59	BF-416	25-1521	62	BF-477	25-1831	63	BK-403	61-1017	32	BR-018	26-4191	77
BF-119	25-1717	65	BF-214-01	25-1238	59	BF-416-01	25-1524	62	BF-477-01	25-1832	63	BK-403-01	61-1021	32	BR-019	26-4193	77
BF-120	25-1716	65	BF-216	25-1423	60	BF-416-02	25-1526	62	BF-480	25-1836	63	BK-404	61-1018	32	BR-019-98	26-1003	70
BF-123	25-1731	65	BF-217	25-1422	60	BF-417	25-1261	61	BF-480-01	25-1837	63	BK-405	61-1019	32	BR-019-99	26-1004	70
BF-124	25-1732	65	BF-218	25-1421	60	BF-418	25-1262	61	BF-480-02	25-1838	63	BK-406	61-1071	34	BR-020	26-1005	70
BF-125	25-1733	65	BF-225	25-1453	68	BF-418-01	25-1263	61	BF-484	25-1141	59	BK-408	61-1011	32	BR-021	26-1006	70
BF-126	25-1734	65	BF-226	25-1452	68	BF-419	25-1264	61	BF-485	25-1142	59	BK-409	61-1020	32	BR-022	26-1007	70
BF-130	25-1743	65	BF-227	25-1451	68	BF-419-01	25-1265	61	BF-486	25-1143	59	BK-410	61-1031	33	BR-023	26-1008	70
BF-131	25-1744	65	BF-301	25-2111	63	BF-420	25-1266	61	BF-490-01	25-1381	62	BK-411	61-1032	33	BR-024	26-1009	70
BF-132	25-1745	65	BF-350	42-1251	228	BF-421	25-1251	61	BF-490-02	25-1387	62	BK-412	61-1221	35	BR-025	26-1010	70

OLD # TO NEW



OLD #	NEW #	PG#	OLD #	NEW #	PG#	OLD #	NEW #	PG#	OLD #	NEW #	PG#	OLD #	NEW #	PG#	OLD #	NEW #	PG#
BR-026	26-1011	70	BR-086	26-1265	70	BR-155	26-2416	72	BR-215	26-1550	71	BR-285	26-1909	72	BR-350	26-2707	73
BR-027	26-1012	70	BR-087	26-1270	70	BR-156	26-2425	72	BR-216-01	26-1308	71	BR-286	26-1910	72	BR-351	26-2708	73
BR-028	26-1013	70	BR-088	26-1275	70	BR-157	26-2418	72	BR-216-02	26-1309	71	BR-288	26-1912	72	BR-352	26-2709	73
BR-029	26-1014	70	BR-089	26-1280	70	BR-158	26-2421	72	BR-217	26-1310	71	BR-290	26-1914	72	BR-353	26-2710	73
BR-030	26-1015	70	BR-090	26-1285	70	BR-159	26-2423	72	BR-218	26-1312	71	BR-291	26-1915	72	BR-354	26-2712	73
BR-031	26-1016	70	BR-091	26-1290	70	BR-160	26-2007	72	BR-218-01	26-1313	71	BR-292	26-1916	72	BR-355	26-2714	73
BR-032	26-1017	70	BR-092	26-1222	70	BR-161	26-2008	72	BR-218-02	26-1314	71	BR-294	26-1918	72	BR-356	26-2716	73
BR-033	26-1018	70	BR-093	26-1295	70	BR-162	26-2009	72	BR-219	26-1315	71	BR-296	26-1921	72	BR-357	26-2718	73
BR-034	26-1019	70	BR-094	26-1300	70	BR-163	26-2010	72	BR-220	26-1316	71	BR-297	26-1923	72	BR-358	26-2721	73
BR-035	26-1020	70	BR-095	26-1109	70	BR-164	26-2012	72	BR-221	26-1317	71	BR-298	26-1925	72	BR-359	26-2723	73
BR-036	26-1021	70	BR-096	26-1110	70	BR-165	26-2014	72	BR-221-01	26-1318	71	BR-299	26-1927	72	BR-360	26-2725	73
BR-037	26-1022	70	BR-097	26-1111	70	BR-166	26-2016	72	BR-221-02	26-1319	71	BR-300	26-1929	72	BR-361	26-2727	73
BR-038	26-1023	70	BR-098	26-1112	70	BR-168	26-2018	72	BR-222	26-1320	71	BR-301	26-1931	72	BR-367	26-2309	72
BR-039	26-1024	70	BR-099	26-1113	70	BR-169	26-2021	72	BR-222-01	26-1321	71	BR-301-01	26-1933	72	BR-368	26-2310	72
BR-040	26-1025	70	BR-100	26-1114	70	BR-170	26-2023	72	BR-223	26-1322	71	BR-301-02	26-1935	72	BR-369	26-2312	72
BR-041	26-1026	70	BR-101	26-1115	70	BR-171	26-2025	72	BR-223-01	26-1323	71	BR-301-03	26-1937	72	BR-370	26-2314	72
BR-042	26-1027	70	BR-102	26-1116	70	BR-172	26-2027	72	BR-223-02	26-1324	71	BR-301-04	26-1940	72	BR-371	26-2316	72
BR-043	26-1028	70	BR-103	26-1117	70	BR-175	26-1180	70	BR-224	26-1325	71	BR-301-05	26-1942	72	BR-372	26-2318	72
BR-044	26-1029	70	BR-104	26-1118	70	BR-176	26-1182	70	BR-225	26-1327	71	BR-301-06	26-1945	72	BR-373	26-2321	72
BR-044-01	26-1030	70	BR-105	26-1119	70	BR-180	26-1706	71	BR-225-01	26-1329	71	BR-301-07	26-1947	72	BR-374	26-2323	72
BR-045	26-1031	70	BR-106	26-1120	70	BR-181	26-1707	71	BR-226	26-1330	71	BR-301-08	26-1950	72	BR-375	26-2325	72
BR-046	26-1033	70	BR-107	26-1121	70	BR-182	26-1708	71	BR-226-01	26-1331	71	BR-302	26-1825	72	BR-380	26-1409	71
BR-047	26-1035	70	BR-108	26-1122	70	BR-183	26-1709	71	BR-227	26-1333	71	BR-303	26-1827	72	BR-381	26-1410	71
BR-048	26-1037	70	BR-109	26-1123	70	BR-184	26-1710	71	BR-228	26-1335	71	BR-304	26-1829	72	BR-382	26-1411	71
BR-049	26-1040	70	BR-110	26-1124	70	BR-184-01	26-1711	71	BR-229	26-1337	71	BR-305	26-1831	72	BR-382-01	26-1412	71
BR-050	26-1042	70	BR-111	26-1125	70	BR-185	26-1712	71	BR-230	26-1340	71	BR-306	26-1833	72	BR-383	26-1413	71
BR-051	26-1045	70	BR-112	26-1127	70	BR-185-01	26-1713	71	BR-231	26-1342	71	BR-307	26-1835	72	BR-384	26-1414	71
BR-052	26-1047	70	BR-113	26-1129	70	BR-186	26-1714	71	BR-232	26-1345	71	BR-308	26-1837	72	BR-385	26-1416	71
BR-053	26-1050	70	BR-114	26-1130	70	BR-186-01	26-1715	71	BR-232-01	26-1347	71	BR-310	26-1809	72	BR-386	26-1417	71
BR-054	26-1055	70	BR-115	26-1131	70	BR-187	26-1716	71	BR-233	26-1350	71	BR-311	26-1811	72	BR-387	26-1418	71
BR-054-01	26-1060	70	BR-116	26-1133	70	BR-188	26-1718	71	BR-235	26-1360	71	BR-312	26-1810	72	BR-388	26-1419	71
BR-054-02	26-1065	70	BR-117	26-1135	70	BR-189	26-1721	71	BR-237	26-1370	71	BR-314	26-1812	72	BR-389	26-1421	71
BR-054-03	26-1070	70	BR-118	26-1137	70	BR-190	26-1723	71	BR-239	26-1380	71	BR-315	26-1813	72	BR-390	26-1422	71
BR-054-04	26-1075	70	BR-119	26-1140	70	BR-191	26-1725	71	BR-242	26-1153	70	BR-316	26-1814	72	BR-391	26-1423	71
BR-054-05	26-1080	70	BR-120	26-1142	70	BR-192	26-1727	71	BR-243	26-1170	70	BR-317	26-1815	72	BR-392	26-2507	73
BR-054-06	26-1085	70	BR-121	26-1145	70	BR-193	26-1729	71	BR-244	26-1159	70	BR-318	26-1816	72	BR-393	26-2508	73
BR-054-07	26-1090	70	BR-122	26-1147	70	BR-194	26-1508	71	BR-248	26-1165	70	BR-319	26-1817	72	BR-394	26-2509	73
BR-054-08	26-1095	70	BR-123	26-1150	70	BR-195	26-1509	71	BR-262	26-1607	71	BR-320	26-1818	72	BR-395	26-2510	73
BR-054-09	26-1100	70	BR-124	26-1128	70	BR-196	26-1510	71	BR-263	26-1608	71	BR-321	26-1819	72	BR-396	26-2512	73
BR-054-99	26-1208	70	BR-125	26-1126	70	BR-196-01	26-1511	71	BR-264	26-1609	71	BR-322	26-1820	72	BR-397	26-2514	73
BR-055	26-1209	70	BR-132	26-2225	72	BR-197	26-1512	71	BR-265	26-1610	71	BR-323	26-1821	72	BR-398	26-2516	73
BR-056	26-1210	70	BR-133	26-2227	72	BR-197-01	26-1513	71	BR-266	26-1612	71	BR-323-01	26-1822	72	BR-399	26-2518	73
BR-057	26-1211	70	BR-134	26-2229	72	BR-198	26-1514	71	BR-267	26-1614	71	BR-324	26-1823	72	BR-399-01	26-2521	73
BR-058	26-1212	70	BR-135	26-2206	72	BR-199	26-1515	71	BR-268	26-1616	71	BR-325	26-1429	71	BR-399-02	26-2523	73
BR-059	26-1213	70	BR-136	26-2207	72	BR-200	26-1516	71	BR-269	26-1618	71	BR-326	26-1415	71	BR-399-10	26-2607	73
BR-061	26-1214	70	BR-137	26-2208	72	BR-200-01	26-1517	71	BR-269-01	26-1621	71	BR-327	26-1420	71	BR-399-11	26-2608	73
BR-062	26-1215	70	BR-138	26-2209	72	BR-201	26-1518	71	BR-269-02	26-1623	71	BR-328	26-1424	71	BR-399-12	26-2609	73
BR-063	26-1216	70	BR-139	26-2210	72	BR-202	26-1519	71	BR-269-03	26-1625	71	BR-330	26-1425	71	BR-399-13	26-2610	73
BR-064	26-1217	70	BR-140	26-2212	72	BR-203	26-1520	71	BR-269-04	26-1627	71	BR-331	26-1427	71	BR-399-14	26-2612	73
BR-071	26-1218	70	BR-141	26-2214	72	BR-204	26-1521	71	BR-269-07	26-2107	72	BR-332	26-1430	71	BR-399-15	26-2614	73
BR-072	26-1219	70	BR-142	26-2216	72	BR-205	26-1522	71	BR-269-98	26-2108	72	BR-333	26-1431	71	BR-399-16	26-2616	73
BR-073	26-1220	70	BR-143	26-2218	72	BR-206	26-1523	71	BR-269-99	26-2109	72	BR-334	26-1433	71	BR-399-17	26-2618	73
BR-074	26-1221	70	BR-144	26-2221	72	BR-207	26-1525	71	BR-270	26-2110	72	BR-335	26-1435	71	BR-399-18	26-2621	73
BR-075	26-1223	70	BR-145	26-2223	72	BR-208	26-1527	71	BR-271	26-2112	72	BR-336	26-1437	71	BR-399-19	26-2623	73
BR-076	26-1225	70	BR-145-99	26-2406	72	BR-209	26-1529	71	BR-272	26-2114	72	BR-337	26-1440	71	BR-399-20	26-2625	73
BR-077	26-1227	70	BR-146	26-2407	72	BR-210	26-1530	71	BR-273	26-2116	72	BR-338	26-1442	71	BR-399-21	26-2627	73
BR-078	26-1229	70	BR-147	26-2408	72	BR-211	26-1531	71	BR-274	26-2118	72	BR-339	26-1445	71	BR-399-22	26-2629	73
BR-079	26-1230	70	BR-148	26-2409	72	BR-212	26-1533	71	BR-275	26-2121	72	BR-340	26-1447	71	BR-400	26-4110	77
BR-080	26-1235	70	BR-149	26-2410	72	BR-212-01	26-1535	71	BR-276	26-2123	72	BR-341	26-1450	71	BR-401	26-4112	77
BR-081	26-1240	70	BR-150	26-2411	72	BR-213	26-1537	71	BR-277	26-2125	72	BR-342	26-1460	71	BR-402	26-4115	77
BR-082	26-1245	70	BR-151	26-2412	72	BR-213-01	26-1540	71	BR-278	26-2127	72	BR-343	26-1470	71	BR-403	26-4117	77
BR-083	26-1250	70	BR-152	26-2413	72	BR-213-02	26-1542	71	BR-282	26-1906	72	BR-345	26-1480	71	BR-404	26-4120	77
BR-084	26-1255	70	BR-153	26-2414	72	BR-214	26-1545	71	BR-283	26-1907	72	BR-346	26-1490	71	BR-405	26-4122	77
BR-085	26-1260	70	BR-154	26-2415	72	BR-214-01	26-1547	71	BR-284	26-1908	72	BR-347	26-1500	71	BR-406	26-4125	77



OLD # TO NEW#

OLD #	NEW #	PG#	OLD #	NEW #	PG#	OLD #	NEW #	PG#	OLD #	NEW #	PG#	OLD #	NEW #	PG#	OLD #	NEW #	PG#
BR-407	26-4127	77	BR-512	26-2763	74	BR-586	26-3204	75	BR-652	26-3310	75	BR-762	26-5218	78	BU-006-04	24-1317	54
BR-408	26-4130	77	BR-513	26-2764	74	BR-587	26-3205	75	BR-653	26-3311	75	BR-768	26-5308	78	BU-006-05	24-1316	54
BR-409	26-4132	77	BR-514	26-2767	74	BR-588	26-3206	75	BR-654	26-3312	75	BR-769	26-5309	78	BU-008	24-1333	54
BR-410	26-4135	77	BR-515	26-2768	74	BR-589	26-3207	75	BR-655	26-3313	75	BR-770	26-5310	78	BU-008-01	24-1332	54
BR-411	26-4137	77	BR-516	30-2601	130	BR-590	26-3208	75	BR-656	26-3314	75	BR-771	26-5312	78	BU-008-02	24-1331	54
BR-412	26-4140	77	BR-517	30-2602	130	BR-591	26-3209	75	BR-657	26-3315	75	BR-772	26-5314	78	BU-009	24-1338	54
BR-413	26-4142	77	BR-518	30-2603	130	BR-592	26-3210	75	BR-658	26-3316	75	BR-774	26-5316	78	BU-009-01	24-1337	54
BR-414	26-4145	77	BR-519	30-2604	130	BR-593	26-3211	75	BR-659	26-3317	75	BR-775	26-5318	78	BU-009-02	24-1336	54
BR-415	26-4147	77	BR-520	30-2605	130	BR-594	26-3212	75	BR-660	26-3318	75	BR-776	26-5321	78	BU-011	24-1151	55
BR-416	26-4150	77	BR-521	30-2606	130	BR-595	26-3213	75	BR-661	26-3319	75	BR-777	26-5323	78	BU-012	24-1152	55
BR-417	26-4152	77	BR-522	30-2607	130	BR-596	26-3214	75	BR-662	26-3320	75	BR-780	26-5412	78	BU-013	24-1153	55
BR-418	26-4155	77	BR-523	30-2608	130	BR-597	26-3215	75	BR-663	26-3322	75	BR-797	26-5002	78	BU-014	24-1154	55
BR-419	26-4157	77	BR-524	30-2609	130	BR-598	26-3216	75	BR-664	26-3323	75	BR-797-01	26-5003	79	BU-015	24-1155	55
BR-420	26-4160	77	BR-525	30-2610	130	BR-599	26-3217	75	BR-665	26-3324	75	BR-798	26-5004	78	BU-016	24-1156	55
BR-421	26-4162	77	BR-526	30-2611	130	BR-600	26-3218	75	BR-666	26-3325	75	BR-800	26-5005	78	BU-017	24-1181	55
BR-422	26-4165	77	BR-527	30-2612	130	BR-601	26-3219	75	BR-667	26-3326	75	BR-801	26-5006	78	BU-018	24-1182	55
BR-423	26-4167	77	BR-528	30-2613	130	BR-602	26-3220	75	BR-668	26-3327	75	BR-802	26-5007	78	BU-019	24-1183	55
BR-424	26-4170	77	BR-529	30-2614	130	BR-603	26-3222	75	BR-669	26-3328	75	BR-803	26-5008	78	BU-023	24-1161	55
BR-425	26-4172	77	BR-530	30-2615	130	BR-604	26-3223	75	BR-670	26-3329	75	BR-804	26-5009	78	BU-023-01	24-1162	55
BR-426	26-4175	77	BR-531	30-2616	130	BR-605	26-3224	75	BR-671	26-3330	75	BR-805	26-5010	78	BU-023-02	24-1173	56
BR-427	26-4177	77	BR-532	30-2617	130	BR-606	26-3225	75	BR-672	26-3331	75	BR-806	26-5011	78	BU-023-03	24-1174	57
BR-428	26-4180	77	BR-533	30-2618	130	BR-607	26-3226	75	BR-673	26-3332	75	BR-807	26-5012	78	BU-023-04	24-1175	58
BR-462	26-5457	79	BR-534	30-2619	130	BR-608	26-3227	75	BR-674	26-3333	75	BR-808	26-5013	78	BU-024	24-1186	55
BR-463	26-5458	79	BR-535	30-2620	130	BR-609	26-3228	75	BR-675	26-3334	75	BR-809	26-5014	78	BU-027	24-1191	55
BR-465	26-5459	79	BR-536	30-2621	130	BR-610	26-3229	75	BR-677	26-3451	76	BR-810	26-5015	78	BU-028	24-1146	54
BR-468	26-5453	79	BR-537	30-2622	130	BR-611	26-3230	75	BR-680	26-3452	76	BR-811	26-5016	78	BU-028-01	24-1147	54
BR-469	26-5454	79	BR-538	30-2623	130	BR-612	26-3231	75	BR-685	26-3453	76	BR-812	26-5017	78	BU-029	24-1017	52
BR-470	26-5451	79	BR-539	30-2624	130	BR-613	26-3232	75	BR-686	26-3454	76	BR-813	26-5018	78	BU-030	24-1018	52
BR-471	26-5452	79	BR-550	26-3101	75	BR-614	26-3233	75	BR-690	26-3455	76	BR-814	26-5019	78	BU-030-01	24-1034	56
BR-476	26-5473	79	BR-551	26-3102	75	BR-615	26-3234	75	BR-692	26-3456	76	BR-815	26-5021	78	BU-031	24-1014	52
BR-477	26-5472	79	BR-552	26-3103	75	BR-616	26-3402	75	BR-694	26-3457	76	BR-816	26-5023	78	BU-032	24-1015	52
BR-478	26-5471	79	BR-553	26-3104	75	BR-617	26-3403	75	BR-700	26-3001	248	BR-824	26-5027	78	BU-033	24-1011	52
BR-479	26-5477	79	BR-554	26-3105	75	BR-618	26-3404	75	BR-701	26-3002	248	BR-841	26-2496	77	BU-033-01	24-1038	56
BR-480	26-5476	79	BR-555	26-3106	75	BR-619	26-3405	75	BR-702	26-3003	248	BR-842	26-2497	77	BU-034	24-1021	52
BR-481	26-5475	79	BR-556	26-3107	75	BR-620	26-3406	75	BR-714	26-2393	78	BR-843	26-2498	77	BU-035	24-1022	52
BR-482	26-5482	79	BR-557	26-3108	75	BR-621	26-3407	75	BR-715	26-2391	78	BR-850	26-5486	79	BU-038	24-1023	52
BR-483	26-5481	79	BR-558	26-3109	75	BR-622	26-3408	75	BR-716	26-2392	78	BR-852	26-5514	80	BU-041	24-1036	56
BR-484	26-5461	79	BR-559	26-3110	75	BR-623	26-3409	75	BR-717	26-2394	78	BR-853	26-5516	80	BU-042	24-1031	56
BR-485	26-5463	79	BR-560	26-3111	75	BR-624	26-3410	75	BR-718	26-2396	78	BR-854	26-5518	80	BU-051	24-1051	56
BR-486	26-5462	79	BR-561	26-3112	75	BR-625	26-3411	75	BR-719	26-2397	78	BR-857	26-5521	80	BU-052	24-1052	56
BR-487	26-5464	79	BR-562	26-3113	75	BR-626	26-3412	75	BR-719-01	26-2398	78	BR-858	26-5522	80	BU-053	24-1053	56
BR-488	26-5465	79	BR-563	26-3114	75	BR-627	26-3413	75	BR-720	26-2399	78	BR-871	26-5551	80	BU-054	24-1054	56
BR-489	26-5466	79	BR-564	26-3115	75	BR-628	26-3414	75	BR-725	23-1115	43	BR-872	26-5552	80	BU-057	24-1061	56
BR-490	26-5467	79	BR-565	26-3116	75	BR-629	26-3415	75	BR-726	23-1116	43	BR-873	26-5553	80	BU-058	24-1062	56
BR-491	26-2752	73	BR-566	26-3117	75	BR-630	26-3416	75	BR-730	49-1041	263	BR-874	26-5554	80	BU-059	24-1063	56
BR-492	26-5483	79	BR-567	26-3118	75	BR-631	26-3417	75	BR-731	49-1042	263	BS-400	23-1121	43	BU-060	24-1064	56
BR-493	26-5484	79	BR-568	26-3119	75	BR-632	26-3418	75	BR-732	49-1043	263	BS-400-01	23-1122	43	BU-064	24-1041	56
BR-494	26-2755	73	BR-569	26-3120	75	BR-633	26-3419	75	BR-733	49-1044	263	BS-401	23-1117	43	BU-100	24-1107	52
BR-495	26-2751	73	BR-570	26-3122	75	BR-634	26-3420	75	BR-734	49-1047	263	BS-402	23-1118	43	BU-101	24-1108	52
BR-496	26-2754	73	BR-571	26-3123	75	BR-635	26-3422	75	BR-741	26-5106	78	BS-405	23-1071	42	BU-107	24-1207	52
BR-497	26-2756	73	BR-572	26-3124	75	BR-637	26-3424	75	BR-742	26-5107	78	BS-410	23-1072	42	BU-109	24-1208	52
BR-498	26-2753	73	BR-573	26-3125	75	BR-639	26-3426	75	BR-743	26-5108	78	BS-411	23-1073	42	BU-110	24-1121	53
BR-499	26-2757	73	BR-574	26-3126	75	BR-640	26-3428	75	BR-744	26-5109	78	BS-412	23-1074	42	BU-111	24-1115	53
BR-500	26-2765	74	BR-575	26-3127	75	BR-641	26-3430	75	BR-745	26-5110	78	BS-413	23-1075	42	BU-112	24-1114	53
BR-501	26-4192	77	BR-576	26-3128	75	BR-642	26-3434	75	BR-746	26-5112	78	BS-414	23-1076	42	BU-113	24-1113	53
BR-502	30-2631	130	BR-577	26-3129	75	BR-643	26-3301	75	BR-747	26-5114	78	BU-001	24-1141	54	BU-114	24-1112	53
BR-503	30-2632	130	BR-578	26-3130	75	BR-644	26-3302	75	BR-749	26-5116	78	BU-002	24-1142	54	BU-115	24-1111	53
BR-504	30-2635	130	BR-579	26-3131	75	BR-645	26-3303	75	BR-750	26-5118	78	BU-003	24-1143	54	BU-116	24-1118	53
BR-505	30-2636	130	BR-580	26-3132	75	BR-646	26-3304	75	BR-755	26-5208	78	BU-004	24-1241	54	BU-117	24-1116	53
BR-506	26-4194	77	BR-581	26-3133	75	BR-647	26-3305	75	BR-756	26-5209	78	BU-005	24-1242	54	BU-118	24-1117	53
BR-507	26-3008	80	BR-582	26-3134	75	BR-648	26-3306	75	BR-757	26-5210	78	BU-006	24-1313	54	BU-119	24-1124	53
BR-508	26-3006	76	BR-583	26-3201	75	BR-649	26-3307	75	BR-758	26-5212	78	BU-006-01	24-1312	54	BU-120	24-1122	53
BR-510	26-2761	74	BR-584	26-3202	75	BR-650	26-3308	75	BR-759	26-5214	78	BU-006-02	24-1311	54	BU-121	24-1123	53
BR-511	26-2762	74	BR-585	26-3203	75	BR-651	26-3309	75	BR-761	26-5216	78	BU-006-03	24-1318	54	BU-122	24-1128	53

OLD # TO NEW



OLD #	NEW #	PG#	OLD #	NEW #	PG#	OLD #	NEW #	PG#	OLD #	NEW #	PG#	OLD #	NEW #	PG#	OLD #	NEW #	PG#
BU-123	24-1126	53	CI-002-02	59-1748	343	CI-074	27-1502	90	CI-133	27-1409	91	CI-269	59-1593	341	CM-440	27-1591	88
BU-124	24-1127	53	CI-003	59-1752	343	CI-074-01	27-1501	90	CI-140	27-1411	91	CI-270	59-1594	341	CM-441	27-1592	88
BU-125	24-1125	53	CI-003-01	59-1753	343	CI-074-02	27-1500	90	CI-141	27-1412	91	CI-271	59-1595	341	CM-442	27-1593	88
BU-128	24-1214	53	CI-004	59-1751	343	CI-075	27-1508	90	CI-142	27-1413	91	CI-272	59-1583	341	CM-443	27-1594	88
BU-128-01	24-1213	53	CI-005	59-1755	343	CI-075-01	27-1504	90	CI-143	27-1414	91	CI-280	59-1601	341	CM-450	27-1601	86
BU-129	24-1212	53	CI-006	59-1756	343	CI-075-02	27-1506	90	CI-144	27-1415	91	CI-281	59-1602	341	CM-451	27-1602	86
BU-129-01	24-1211	53	CI-007	59-1757	343	CI-076	27-1468	100	CI-150	27-1416	91	CI-282	59-1603	341	CM-452	27-1603	86
BU-130	24-1217	53	CI-008	59-1758	343	CI-077	27-1469	100	CI-151	27-1417	91	CI-283	59-1604	341	CM-453	27-1604	86
BU-130-01	24-1218	53	CI-009	59-1759	343	CI-078	27-1466	100	CI-152	27-1418	91	CI-284	59-1605	341	CM-454	27-1605	86
BU-131	24-1215	53	CI-010	59-1760	343	CI-079	27-1467	100	CI-153	27-1419	91	CI-285	59-1608	341	CM-455	27-1606	86
BU-131-01	24-1216	53	CI-011	59-1754	343	CI-080	27-1555	90	CI-154	27-1420	91	CI-286	59-1609	341	CM-457	27-1609	86
BU-132	24-1222	53	CI-024	59-1641	340	CI-081	27-1537	92	CI-161	27-1422	91	CI-287	59-1610	341	CM-500	27-1683	86
BU-133	24-1221	53	CI-025	59-1642	340	CI-082	27-1436	91	CI-162	27-1423	91	CI-288	59-1611	341	CM-501	27-1684	86
BU-133-01	24-1223	53	CI-026	59-1643	340	CI-083	27-1447	91	CI-163	27-1424	91	CI-289	59-1612	341	CM-502	27-1685	86
BU-133-02	24-1224	53	CI-026-01	59-1644	340	CI-084	27-1445	91	CI-164	27-1425	91	CI-290	59-1613	341	CM-900	27-1702	88
BU-134	24-1232	53	CI-027	59-1645	340	CI-085	27-1141	94	CI-170	27-1111	95	CI-291	59-1614	341	CM-901	27-1703	88
BU-135	24-1231	53	CI-028	27-1085	94	CI-086	27-1142	94	CI-171	27-1112	95	CI-292	59-1615	341	CM-902	27-1701	88
BU-136	24-1233	53	CI-030	27-1081	94	CI-086-01	27-1143	94	CI-172	27-1114	95	CI-293	59-1616	341	CM-903	27-1707	88
BU-137	24-1234	53	CI-032	27-1082	94	CI-086-02	27-1144	94	CI-173	27-1115	95	CI-294	59-1617	341	CM-904	27-1708	88
BU-140	24-1101	52	CI-033	27-1089	94	CI-086-03	27-1145	94	CI-200	27-1121	95	CI-295	59-1618	341	CM-905	27-1711	87
BU-141	24-1102	52	CI-034	27-1452	91	CI-086-04	27-1146	94	CI-201	27-1122	95	CI-296	59-1619	341	CM-906	27-1712	87
BU-142	24-1103	52	CI-035	27-1453	91	CI-087	27-1542	92	CI-206	27-1131	95	CI-297	59-1620	341	CR-590	27-1379	93
BU-143	24-1104	52	CI-036	27-1454	91	CI-088	27-1541	92	CI-206-01	27-1132	95	CI-298	59-1621	341	CR-600	27-1597	88
BU-144	24-1201	52	CI-037	27-1455	91	CI-089	27-1543	92	CI-206-02	27-1133	95	CI-299	59-1622	341	CR-600-01	27-1598	88
BU-144-01	24-1202	52	CI-038	27-1457	91	CI-090	27-1544	92	CI-230	27-1161	96	CL-001	28-1411	108	CR-601	27-1622	84
BU-144-02	24-1203	52	CI-039	27-1448	91	CI-091	27-1551	91	CI-231	27-1162	96	CL-002	28-1412	108	CR-602	27-1625	84
BU-144-03	24-1204	52	CI-040	27-1449	91	CI-091-01	27-1552	91	CI-232	27-1166	96	CL-005	28-1414	108	CR-603	27-1624	84
BU-150	24-1081	56	CI-041	27-1438	91	CI-092	27-1203	97	CI-233	27-1167	96	CL-006	28-1415	108	CR-604	27-1626	84
BU-151	24-1082	56	CI-042	27-1458	91	CI-093	27-1204	97	CI-234	27-1168	96	CL-007	28-1416	108	CR-605	27-1621	84
BU-152	24-1083	56	CI-043	27-1391	92	CI-094	27-1207	97	CI-234-01	27-1169	96	CL-008	28-1417	108	CR-610	27-1628	84
BU-153	24-1084	56	CI-044	27-1392	92	CI-095	27-1208	97	CI-234-02	27-1171	96	CL-009	28-1418	108	CR-611	27-1618	84
BU-154	24-1085	56	CI-044-01	27-1393	92	CI-095-01	27-1211	97	CI-234-03	27-1170	96	CL-010	28-1419	108	CR-612	27-1638	84
BU-155	24-1086	56	CI-045	27-1394	92	CI-095-02	27-1212	97	CI-238	27-1241	98	CL-011	28-1421	108	CR-614	27-1627	84
BU-156	24-1087	56	CI-045-01	27-1395	92	CI-096	27-1202	97	CI-239	27-1242	98	CL-012	28-1424	108	CR-615	27-1617	84
BU-157	24-1088	56	CI-045-02	27-1384	92	CI-097	27-1201	97	CI-240	27-1243	98	CL-013	28-1425	108	CR-616	27-1637	84
BU-158	24-1089	56	CI-045-03	27-1383	92	CI-097-01	27-1205	97	CI-241	27-1244	98	CL-014	28-1426	108	CR-618	27-1623	84
BU-159	24-1090	56	CI-045-04	27-1382	92	CI-097-02	27-1206	97	CI-242	27-1245	98	CL-015	28-1427	108	CR-619	27-1613	84
CB-153	27-1351	93	CI-045-05	27-1381	92	CI-097-03	27-1209	97	CI-243	27-1246	98	CL-016	28-1431	108	CR-620	27-1633	84
CB-203	27-1352	93	CI-046	27-1446	91	CI-097-04	27-1210	97	CI-245	27-1247	98	CL-017	28-1432	108	CR-630-01	27-1661	85
CB-251	27-1361	93	CI-047	27-1431	91	CI-098	27-1215	97	CI-246	27-1248	98	CL-018	28-1433	108	CR-630-03	27-1662	85
CB-252	27-1366	93	CI-048	27-1450	91	CI-098-01	27-1216	97	CI-247	27-1249	98	CL-019	28-1239	105	CR-630-05	27-1663	85
CB-253	27-1353	93	CI-049	27-1451	91	CI-099	27-1217	97	CI-248	27-1250	98	CL-020	28-1075	103	CR-630-07	27-1664	85
CB-301	27-1362	93	CI-050	27-1521	92	CI-099-01	27-1218	97	CI-250	27-1176	207	CL-022	28-1076	103	CR-630-09	27-1665	85
CB-302	27-1367	93	CI-051	27-1522	92	CI-099-02	27-1219	97	CI-250-01	27-1177	207	CL-027	28-1071	103	CR-630-11	27-1666	85
CB-303	27-1354	93	CI-052	27-1523	92	CI-100	27-1231	97	CI-251	27-1181	96	CL-028	28-1072	103	CR-630-13	27-1667	85
CB-351	27-1363	93	CI-053	27-1524	92	CI-101	27-1233	97	CI-252	27-1183	96	CL-035	28-1241	105	CR-630-14	27-1669	85
CB-352	27-1368	93	CI-054	27-1525	92	CI-102	27-1232	97	CI-253	27-1182	96	CM-034	27-1562	88	CR-631	27-1643	84
CB-353	27-1355	93	CI-055	27-1526	92	CI-103	27-1234	97	CI-254	27-1184	96	CM-058	27-1563	88	CR-631-01	27-1644	84
CB-401	27-1364	93	CI-056	27-1456	91	CI-105	27-1511	90	CI-255	27-1185	96	CM-059	27-1561	88	CR-631-02	27-1645	84
CB-402	27-1369	93	CI-057	27-1482	91	CI-106	27-1512	90	CI-256	27-1186	96	CM-100	27-1564	88	CR-631-03	27-1646	84
CB-403	27-1356	93	CI-060	27-1481	91	CI-106-01	27-1513	90	CI-257	27-1187	96	CM-125	27-1565	88	CR-631-04	27-1647	84
CB-501	27-1365	93	CI-061	27-1483	91	CI-106-02	27-1514	90	CI-257-01	27-1188	96	CM-129	27-1567	88	CR-631-05	27-1648	84
CB-503	27-1357	93	CI-062	27-1484	91	CI-107	27-1462	91	CI-258	27-1189	96	CM-150	27-1566	88	CR-650	27-1671	86
CB-603	27-1358	93	CI-063	27-1485	91	CI-108	27-1463	91	CI-258-01	27-1190	96	CM-201	27-1574	88	CR-651	27-1674	86
CB-610	27-1376	93	CI-064	27-1471	91	CI-109	27-1073	85	CI-259	27-1228	96	CM-202	27-1573	88	CR-652	27-1677	86
CB-611	27-1378	93	CI-065	27-1472	91	CI-109-01	27-1074	85	CI-260	59-1581	341	CM-203	27-1571	88	CR-653	27-1672	86
CB-615	27-1371	93	CI-066	27-1473	91	CI-110	27-1076	85	CI-261	59-1582	341	CM-234	27-1572	88	CR-654	27-1675	86
CB-616	27-1372	93	CI-067	27-1474	91	CI-110-01	27-1077	85	CI-262	59-1586	341	CM-301	27-1575	88	CR-655	27-1678	86
CB-617	27-1373	93	CI-068	27-1531	92	CI-112	27-1091	94	CI-263	59-1587	341	CM-302	27-1576	88	CR-656	27-1673	86
CB-618	27-1374	93	CI-069	27-1532	92	CI-113	27-1092	94	CI-264	59-1588	341	CM-432	27-1581	88	CR-657	27-1676	86
CB-619	27-1375	93	CI-070	27-1533	92	CI-120	27-1401	91	CI-265	59-1589	341	CM-433	27-1582	88	CR-658	27-1679	86
CI-001	59-1745	343	CI-071	27-1534	92	CI-130	27-1406	91	CI-266	59-1590	341	CM-434	27-1583	88	CR-660	27-1696	87
CI-002	59-1746	343	CI-072	27-1535	92	CI-131	27-1407	91	CI-267	59-1591	341	CM-435	27-1584	88	CR-670	27-1717	87
CI-002-01	59-1747	343	CI-073	27-1536	92	CI-132	27-1408	91	CI-268	59-1592	341	CM-436	27-1587	88	CR-700	27-1611	84



OLD # TO NEW#

OLD #	NEW #	PG#	OLD #	NEW #	PG#	OLD #	NEW #	PG#	OLD #	NEW #	PG#	OLD #	NEW #	PG#	OLD #	NEW #	PG#
CR-701	27-1612	84	CS-114	59-1734	342	CU-723	27-1313	99	CW-063	59-2755	335	CW-129	59-2899	335	CW-221	27-1517	90
CR-702	27-1615	84	CS-115	59-1735	342	CU-724	27-1314	99	CW-064	59-2756	335	CW-136	59-2951	338	CW-222	59-1071	328
CR-703	27-1614	84	CS-116	59-1736	342	CU-724-01	27-1315	99	CW-065	59-2757	335	CW-137	59-2952	338	CW-223	59-1072	328
CR-704	27-1616	84	CS-117	59-1737	342	CU-725	27-1316	99	CW-066	59-2760	335	CW-138	59-2947	338	CW-224	59-1073	328
CR-706	27-1634	84	CS-118	59-1738	342	CU-726	27-1318	99	CW-067	59-2761	335	CW-139	59-2948	338	CW-225	59-1074	328
CR-707	27-1636	84	CS-156	59-1730	342	CW-001	59-1151	330	CW-068	59-2762	335	CW-140	59-2955	338	CW-226	59-1075	328
CR-708	27-1654	84	CS-204	59-1772	344	CW-002	59-1154	330	CW-069	59-2765	335	CW-141	59-2956	338	CW-227	59-1076	328
CR-708-01	27-1658	84	CS-205	59-1626	340	CW-003	59-1152	330	CW-070	59-2766	335	CW-142	59-2957	338	CW-228	59-1077	328
CR-710	27-1693	86	CS-206	59-1627	340	CW-004	59-1155	330	CW-071	59-2767	335	CW-143	59-2958	338	CW-229	59-1078	328
CR-711	27-1692	86	CS-215	27-1721	87	CW-005	59-1153	330	CW-072	59-2770	335	CW-144	59-2945	338	CW-230	59-1079	328
CR-712	27-1691	86	CS-216	27-1722	87	CW-006	59-1156	330	CW-073	59-2771	335	CW-145	59-2946	338	CW-231	59-1081	328
CR-713	27-1695	86	CS-218	27-1723	87	CW-008	59-1161	330	CW-074	59-2772	335	CW-147	59-3200	338	CW-232	59-1082	328
CR-714	27-1681	86	CS-220	27-1498	92	CW-009	59-1162	330	CW-075	59-2720	334	CW-149	59-2845	337	CW-233	59-1083	328
CR-818	27-1699	87	CS-222	27-1497	92	CW-010	59-1511	332	CW-076	59-2750	335	CW-150	59-2850	337	CW-234	59-1084	328
CR-819	27-1698	87	CT-001	40-1331	206	CW-010-01	59-1165	330	CW-077	59-2773	336	CW-152	59-3102	339	CW-235	59-1085	328
CR-820	27-1697	87	CT-002	40-1332	206	CW-011	59-1512	332	CW-078	59-2774	336	CW-153	59-3103	339	CW-236	59-1086	328
CR-821	27-1715	87	CT-003	40-1333	206	CW-014	59-1761	343	CW-079	59-2775	336	CW-154	59-3104	339	CW-237	59-1094	328
CR-900	27-1052	83	CT-004	40-1334	206	CW-015	59-1762	343	CW-080	59-2776	336	CW-155	59-3105	339	CW-238	59-1095	328
CR-901	27-1051	83	CT-007	40-1341	206	CW-016	59-1471	331	CW-081	59-2777	336	CW-156	59-3106	339	CW-239	59-1096	328
CR-902	27-1056	83	CT-008	40-1342	206	CW-017	59-1472	331	CW-082	59-2778	336	CW-160	59-3100	339	CW-240	59-1097	328
CR-903	27-1057	83	CT-009	40-1343	206	CW-018	59-1473	331	CW-082-01	59-2779	336	CW-163	59-3110	339	CW-241	59-1098	328
CR-904	27-1053	83	CT-010	40-1344	206	CW-019	59-1474	331	CW-082-02	59-2781	336	CW-164	59-1781	344	CW-242	59-1099	328
CR-906	27-1061	83	CT-011	40-1345	206	CW-020	59-1475	331	CW-082-03	59-2782	336	CW-168	59-1580	336	CW-243	59-1087	328
CR-906-01	27-1062	83	CT-012	40-1346	206	CW-022	59-1481	331	CW-082-04	59-2783	336	CW-169	59-1579	336	CW-244	59-1088	328
CR-907	27-1066	83	CT-013	40-1347	206	CW-023	59-1482	331	CW-082-05	59-2784	336	CW-169-01	59-1801	344	CW-245	59-1089	328
CR-907-01	27-1067	83	CT-013-01	40-1351	206	CW-024	59-1911	332	CW-082-06	59-2785	336	CW-169-02	59-1802	344	CW-246	59-1091	328
CR-910	59-1573	333	CT-013-02	40-1352	206	CW-025	59-1912	332	CW-082-07	59-2786	336	CW-169-03	59-1803	344	CW-247	59-1092	328
CR-911	59-1574	333	CT-013-03	40-1353	206	CW-026	59-1916	332	CW-082-08	59-2787	336	CW-169-04	59-1804	344	CW-248	59-1093	328
CR-920	59-1571	333	CT-013-04	40-1354	206	CW-027	59-1921	332	CW-082-09	59-2788	336	CW-169-05	59-1805	344	CW-250	59-1011	326
CR-921	59-1572	333	CT-013-05	40-1355	206	CW-028	59-1922	332	CW-082-10	59-2789	336	CW-169-06	59-1806	344	CW-251	59-1012	326
CR-930	59-1575	333	CT-013-06	40-1356	206	CW-029	59-1926	332	CW-082-11	59-2790	336	CW-169-07	59-1807	344	CW-252	59-1013	326
CR-931	59-1576	333	CT-017	40-1335	206	CW-030	59-2690	334	CW-082-12	59-2791	336	CW-169-08	59-1808	344	CW-253	59-1014	326
CR-940	59-1577	333	CT-020	40-1311	207	CW-031	59-2691	334	CW-082-13	59-2792	336	CW-169-09	59-1809	344	CW-254	59-1015	326
CS-001	59-1701	340	CT-025	40-1312	207	CW-032	59-2692	334	CW-083	59-2802	337	CW-169-10	59-1810	344	CW-255	59-1016	326
CS-002	59-1702	340	CT-026	40-1313	207	CW-033	59-2693	334	CW-085	59-2885	336	CW-179-01	59-1497	332	CW-256	59-1017	326
CS-003	59-1703	340	CT-027	40-1314	207	CW-034	59-2694	334	CW-090	59-2887	338	CW-179-02	59-1498	332	CW-257	59-1018	326
CS-004	59-1704	340	CT-028	40-1315	207	CW-035	59-2695	334	CW-098	59-2804	337	CW-179-03	59-1499	332	CW-258	59-1019	326
CS-005	59-1705	340	CT-029	40-1316	207	CW-036	59-2696	334	CW-099	59-2886	337	CW-179-04	59-1500	332	CW-300	59-1034	326
CS-006	59-1706	340	CT-030	40-1317	207	CW-037	59-2697	334	CW-100	59-1771	344	CW-179-05	59-1501	332	CW-301	59-1035	326
CS-007	59-1707	340	CU-600	27-1494	92	CW-038	59-2698	334	CW-101	59-2920	336	CW-179-06	59-1502	332	CW-302	59-1036	326
CS-008	59-1708	340	CU-601	27-1495	92	CW-039	59-2699	334	CW-102	59-2803	337	CW-179-07	59-1503	332	CW-303	59-1037	326
CS-009	59-1709	340	CU-604	27-1492	92	CW-040	59-2700	334	CW-103	59-2801	337	CW-179-08	59-1504	332	CW-304	59-1038	326
CS-010	59-1710	340	CU-606	27-1298	98	CW-041	59-2701	334	CW-104	59-2810	338	CW-180	27-1741	89	CW-305	59-1039	326
CS-011	59-1711	340	CU-607	27-1299	98	CW-042	59-2702	334	CW-105	59-2811	338	CW-180-01	27-1742	89	CW-306	59-1024	326
CS-012	59-1712	340	CU-698	27-1261	99	CW-043	59-2703	334	CW-106	59-2812	338	CW-180-02	27-1743	89	CW-307	59-1025	326
CS-013	59-1713	340	CU-699	27-1262	99	CW-044	59-2704	334	CW-107	59-2815	338	CW-181	27-1746	89	CW-308	59-1026	326
CS-014	59-1714	340	CU-700	27-1235	97	CW-045	59-2705	334	CW-108	59-2816	338	CW-182	27-1744	89	CW-309	59-1027	326
CS-015	59-1715	340	CU-702	27-1236	97	CW-046	59-2706	334	CW-109	59-2817	338	CW-183	27-1747	89	CW-310	59-1028	326
CS-016	59-1716	340	CU-702-01	27-1254	98	CW-047	59-2707	334	CW-110	59-2820	338	CW-184	27-1751	89	CW-311	59-1029	326
CS-017	59-1717	340	CU-702-02	27-1255	98	CW-048	59-2708	334	CW-111	59-2821	338	CW-185	27-1745	89	CW-312	59-1031	326
CS-018	59-1718	340	CU-707	27-1271	99	CW-049	59-2709	334	CW-112	59-2822	338	CW-187	27-1752	89	CW-313	59-1032	326
CS-019	59-1719	340	CU-708	27-1272	99	CW-050	59-2710	334	CW-113	59-2830	337	CW-187-01	27-1753	89	CW-314	59-1033	326
CS-020	59-1720	340	CU-709	27-1274	99	CW-051	59-2711	334	CW-114	59-2835	337	CW-190	27-1557	90	CW-324	59-1021	326
CS-022	59-1722	340	CU-710	27-1276	99	CW-052	59-2712	334	CW-115	59-3112	339	CW-200	27-1033	82	CW-325	59-1022	326
CS-023	59-1723	340	CU-712	27-1284	99	CW-053	59-2713	334	CW-117	59-3113	339	CW-202	27-1034	82	CW-326	59-1023	326
CS-024	59-1724	340	CU-715	27-1283	99	CW-054	59-2714	334	CW-118	59-3114	339	CW-205	27-1035	82	CW-329	59-1051	327
CS-025	59-1725	340	CU-716	27-1266	99	CW-055	59-2715	334	CW-119	59-3115	339	CW-206	27-1036	82	CW-330	59-1052	327
CS-030	59-1778	344	CU-717	27-1267	99	CW-056	59-2716	334	CW-121	59-2880	337	CW-207	27-1031	82	CW-331	59-1053	327
CS-031	59-1775	344	CU-718	27-1281	99	CW-057	59-2717	334	CW-122	59-2891	336	CW-208	27-1032	82	CW-332	59-1054	327
CS-032	59-1776	344	CU-719	27-1282	99	CW-058	59-2718	334	CW-123	59-2890	336	CW-209	27-1039	82	CW-333	59-1055	327
CS-100	59-1764	343	CU-720	27-1268	99	CW-059	59-2719	334	CW-124	59-2895	337	CW-215	27-1021	82	CW-334	59-1056	327
CS-111	59-1731	342	CU-720-01	27-1269	99	CW-060	59-2751	335	CW-125	59-3116	339	CW-216	27-1022	82	CW-335	59-1041	327
CS-112	59-1732	342	CU-721	27-1311	99	CW-061	59-2752	335	CW-126	59-2897	335	CW-217	27-1025	82	CW-336	59-1042	327
CS-113	59-1733	342	CU-722	27-1312	99	CW-062	59-2753	335	CW-128	59-2898	335	CW-218	27-1026	82	CW-337	59-1043	327

OLD # TO NEW



OLD #	NEW #	PG#	OLD #	NEW #	PG#	OLD #	NEW #	PG#	OLD #	NEW #	PG#	OLD #	NEW #	PG#	OLD #	NEW #	PG#
CW-338	59-1046	327	CW-452	59-1465	329	DB-507	29-1137	113	DC-088-02	42-1418	230	DI-003	30-1283	128	DI-093	30-1223	127
CW-339	59-1047	327	CW-453	59-1453	329	DB-508	29-1138	113	DC-110	29-1041	111	DI-004	30-1284	128	DI-094	30-1224	127
CW-340	59-1048	327	CW-454	59-1454	329	DB-509	29-1139	113	DC-111	29-1042	111	DI-005	30-1285	128	DI-095	30-1225	127
CW-341	59-1551	333	CW-455	59-1451	329	DB-510	29-1140	113	DC-112	29-1043	111	DI-006	30-1286	128	DI-096	49-1023	262
CW-342	59-1552	333	CW-456	59-1452	329	DB-511	29-1141	113	DC-113	29-1044	111	DI-007	30-1287	128	DI-097	49-1022	262
CW-343	59-1553	333	CW-457	59-1455	329	DC-001	42-1241	228	DC-113-01	29-1045	111	DI-008	30-1288	128	DI-098	49-1016	262
CW-344	59-1554	333	CW-458	59-1456	329	DC-002	42-1242	228	DC-113-02	29-1046	111	DI-010	30-1091	116	DI-099	49-1015	262
CW-345	59-1555	333	CW-459	59-1461	329	DC-011	42-1265	229	DC-114	29-1047	111	DI-011	30-1092	116	DI-100	23-1111	43
CW-346	59-1556	333	CW-460	59-1463	329	DC-012	42-1275	229	DC-116	29-1048	111	DI-014	30-1251	128	DI-101	23-1112	43
CW-347	59-1557	333	CW-466	59-1441	329	DC-013	42-1285	229	DC-117	29-1049	111	DI-015	30-1252	128	DI-102	49-1027	262
CW-348	59-1558	333	CW-467	59-1442	329	DC-014	42-1261	229	DC-118	29-1050	111	DI-016	30-1253	128	DI-103	30-1228	127
CW-355	59-1563	333	CW-468	59-1449	329	DC-015	42-1262	229	DC-119	29-1051	111	DI-022	30-1256	128	DI-105	30-1231	127
CW-356	59-1564	333	CW-469	59-1450	329	DC-016	42-1271	229	DC-120	29-1052	111	DI-035	30-1061	116	DI-106	30-1232	127
CW-357	59-1565	333	CW-470	59-1443	329	DC-017	42-1272	229	DC-122	29-1053	111	DI-036	30-1062	116	DI-107	30-1235	127
CW-360	59-1569	333	CW-471	59-1444	329	DC-018	42-1281	229	DC-123	29-1054	111	DI-037	30-1063	116	DI-108	30-1236	127
CW-363	59-1101	328	CW-472	59-1445	329	DC-020	42-1282	229	DC-124	29-1055	111	DI-038	30-1064	116	DI-109	30-1188	117
CW-363-01	59-1121	328	CW-473	59-1446	329	DC-022	42-1381	229	DC-125	29-1056	111	DI-040	30-1011	116	DI-110	30-1189	117
CW-364	59-1102	328	CW-474	59-1447	329	DC-022-01	42-1382	229	DC-125-01	29-1057	111	DI-041	30-1012	116	DI-110-99	23-1131	43
CW-364-01	59-1122	328	CW-475	59-1448	329	DC-025	42-1311	227	DC-126	29-1058	111	DI-043	30-1013	116	DI-111	23-1132	43
CW-365	59-1103	328	CW-476	59-1462	329	DC-025-01	42-1312	227	DC-126-01	29-1059	111	DI-044	30-1017	116	DI-112	23-1133	43
CW-365-01	59-1123	328	CW-480	59-5121	50	DC-025-02	42-1316	227	DC-127	29-1060	111	DI-045	30-1018	116	DI-113	30-1191	119
CW-366	59-1104	328	CW-481	59-5122	50	DC-026	42-1317	227	DC-128	29-1061	111	DI-045-01	30-1021	117	DI-114	30-1194	119
CW-366-01	59-1124	328	CW-482	59-5123	50	DC-027	42-1321	227	DC-129	29-1062	111	DI-045-02	30-1022	117	DI-115	30-1195	119
CW-367	59-1105	328	DB-018	29-1087	111	DC-030	21-2771	23	DC-129-01	29-1063	111	DI-045-03	30-1023	117	DI-116	30-1182	117
CW-367-02	59-1125	328	DB-024	29-1088	111	DC-031	21-2772	23	DC-129-02	29-1064	111	DI-045-04	30-1024	117	DI-117	30-1181	117
CW-368	59-1106	328	DB-036	29-1089	111	DC-039	42-1324	227	DC-130	29-1065	111	DI-045-05	30-1025	117	DI-118	30-1183	117
CW-368-01	59-1126	328	DB-043	29-1151	114	DC-039-01	42-1325	227	DC-131	29-1066	111	DI-045-06	30-1026	117	DI-119	30-1184	117
CW-369	59-1107	328	DB-044	29-1152	114	DC-040	42-1361	227	DC-132	29-1067	111	DI-045-07	30-1027	116	DI-140	30-1361	126
CW-369-01	59-1127	328	DB-045	29-1154	114	DC-041	42-1362	227	DC-133	29-1068	111	DI-045-08	30-1028	116	DI-141	30-1359	126
CW-370	59-1111	328	DB-046	29-1153	114	DC-042	42-1363	227	DC-133-01	29-1069	111	DI-045-10	30-1029	116	DI-150	30-1302	126
CW-370-01	59-1131	328	DB-055	29-1011	110	DC-043	42-1364	227	DC-133-02	29-1070	111	DI-045-11	30-1030	116	DI-151	30-1301	126
CW-371	59-1112	328	DB-065	29-1012	110	DC-044	42-1371	227	DC-133-03	29-1071	111	DI-045-12	30-1031	116	DI-158	30-1312	126
CW-371-01	59-1132	328	DB-155	29-1014	110	DC-045	42-1351	227	DC-134	29-1072	111	DI-045-13	30-1032	116	DI-159	30-1311	126
CW-372	59-1113	328	DB-165	29-1015	110	DC-045-01	42-1352	227	DC-134-01	29-1073	111	DI-045-14	30-1033	116	DI-164	30-1322	126
CW-372-01	59-1133	328	DB-166	29-1093	111	DC-046	42-1353	227	DC-135	29-1074	111	DI-045-15	30-1034	116	DI-165	30-1321	126
CW-373	59-1114	328	DB-197	29-1091	111	DC-046-01	42-1354	227	DC-135-01	29-1075	111	DI-045-16	30-1035	116	DI-169	30-1331	126
CW-373-01	59-1134	328	DB-199	29-1092	111	DC-048	42-1341	227	DC-136	29-1076	111	DI-045-17	30-1036	116	DI-170	30-1332	126
CW-374	59-1115	328	DB-200	29-1040	111	DC-048-01	42-1342	227	DC-270	29-1121	113	DI-045-18	30-1037	116	DI-172	30-1326	127
CW-374-01	59-1135	328	DB-205	29-1111	112	DC-054	42-1344	227	DC-271	29-1123	113	DI-045-19	30-1038	116	DI-173	30-1327	127
CW-375	59-1116	328	DB-206	29-1112	112	DC-055	42-1345	227	DC-272	29-1122	113	DI-045-20	30-1039	116	DI-175	30-1351	127
CW-375-01	59-1136	328	DB-207	29-1113	112	DC-056	42-1346	227	DC-275	29-1126	113	DI-045-21	30-1040	116	DI-176	30-1358	127
CW-376	59-1117	328	DB-210	29-1114	112	DC-057	42-1347	227	DC-276	29-1127	113	DI-045-22	30-1041	116	DI-180	30-1357	127
CW-376-01	59-1137	328	DB-211	29-1115	112	DC-062	42-1221	228	DC-280	42-1441	230	DI-045-23	30-1042	116	DI-181	30-1354	127
CW-377	59-1141	328	DB-212	29-1116	112	DC-063	42-1222	228	DC-281	42-1442	230	DI-045-24	30-1043	116	DI-190	30-1151	117
CW-378	59-1142	328	DB-218	29-1081	111	DC-064	42-1223	228	DC-282	42-1444	230	DI-045-25	30-1044	116	DI-191	30-1152	117
CW-381	59-1061	327	DB-224	29-1082	111	DC-065	42-1224	228	DC-283	42-1445	230	DI-045-26	30-1045	116	DI-192	30-1153	117
CW-382	59-1059	327	DB-236	29-1083	111	DC-066	42-1225	228	DC-284	42-1447	230	DI-045-27	30-1046	116	DI-193	30-1154	117
CW-383	59-1057	327	DB-336	29-1094	111	DC-067	42-1226	228	DC-285	42-1448	230	DI-045-28	30-1047	116	DI-196	30-1131	117
CW-384	59-1058	327	DB-340	29-1095	111	DC-068	42-1231	228	DC-286	42-1451	230	DI-045-29	30-1048	116	DI-197	30-1132	117
CW-408	59-1171	330	DB-345	29-1096	111	DC-069	42-1232	228	DC-287	42-1452	230	DI-045-30	30-1049	116	DI-198	30-1133	117
CW-409	59-1172	330	DB-350	29-1097	111	DC-070	42-1233	228	DC-288	42-1453	230	DI-045-31	30-1050	116	DI-199	30-1141	117
CW-410	59-1064	327	DB-355	29-1161	114	DC-070-01	42-1235	22	DC-291	42-1514	230	DI-050	30-1071	116	DI-200	30-1142	117
CW-411	59-1065	327	DB-356	29-1021	110	DC-071	42-1234	228	DC-291-01	42-1515	230	DI-052	30-1081	116	DI-201	30-1111	117
CW-414	59-1145	333	DB-357	29-1022	110	DC-072	42-1211	228	DC-292	42-1516	230	DI-070	30-1072	116	DI-202	30-1112	117
CW-415	59-1181	330	DB-360	29-1026	110	DC-073	42-1212	228	DC-292-01	42-1517	230	DI-072	30-1082	116	DI-203	30-1113	117
CW-415-01	59-1182	330	DB-361	29-1024	110	DC-074	42-1213	228	DC-295	42-1510	230	DI-080	30-1073	116	DI-211	30-1143	117
CW-416	59-1183	330	DB-362	29-1028	110	DC-075	42-1214	228	DC-295-01	42-1511	230	DI-082	30-1083	116	DI-212	30-1115	117
CW-418	59-1174	330	DB-365	29-1031	110	DC-078	42-1291	229	DC-296	42-1512	230	DI-083	30-1074	116	DI-213	30-1116	117
CW-419	59-1175	330	DB-501	29-1131	113	DC-079	42-1292	229	DC-296-01	42-1513	230	DI-084	30-1084	116	DI-214	30-1117	117
CW-420	59-1178	330	DB-502	29-1132	113	DC-080	42-1295	229	DC-297	42-1521	230	DI-085	30-1197	123	DI-221	30-1121	117
CW-421	59-1179	330	DB-503	29-1133	113	DC-086	42-1411	230	DC-298	42-1524	230	DI-089	30-1198	123	DI-222	30-1122	117
CW-440	59-1578	333	DB-504	29-1134	113	DC-087	42-1412	230	DC-299	42-1527	230	DI-090	30-1221	127	DI-223	30-1123	117
CW-442	59-1625	342	DB-505	29-1135	113	DC-088	42-1416	230	DI-001	30-1281	128	DI-091	49-1021	262	DI-224	30-1124	117
CW-451	59-1464	329	DB-506	29-1136	113	DC-088-01	42-1417	230	DI-002	30-1282	128	DI-092	30-1222	127	DI-225	30-1125	117



OLD # TO NEW#

OLD #	NEW #	PG#	OLD #	NEW #	PG#	OLD #	NEW #	PG#	OLD #	NEW #	PG#	OLD #	NEW #	PG#	OLD #	NEW #	PG#
DI-226	30-1126	117	DR-074	31-1174	132	DR-193	30-1476	129	EN-006	32-1244	143	EN-068	32-1175	141	EN-119	37-1693	178
DI-299	30-1161	117	DR-075	31-1175	132	DR-194	30-1477	129	EN-007	32-1241	143	EN-069	32-1177	141	EN-120	37-1694	178
DI-300	30-1162	117	DR-076	31-1176	132	DR-195	30-1478	129	EN-008	32-1261	143	EN-069-01	32-1171	141	EN-121	37-1695	178
DI-301	30-1163	117	DR-077	31-1177	132	DR-196	30-1479	129	EN-008-01	32-1263	143	EN-069-02	32-1173	141	EN-140	32-1371	146
DI-302	30-1164	117	DR-078	31-1178	132	DR-197	30-2651	130	EN-008-02	32-1264	143	EN-070	32-1191	141	EN-140-01	32-1372	146
DI-316	49-1211	265	DR-079	31-1179	132	DR-200	30-1355	130	EN-008-03	32-1268	143	EN-070-01	32-1192	141	EN-140-02	32-1373	146
DI-317	49-1212	265	DR-080	31-1180	132	DR-201	30-1356	130	EN-009	32-1242	143	EN-070-02	32-1183	141	EN-140-03	32-1374	146
DI-318	49-1217	265	DR-082	31-1221	133	DR-205	31-1125	132	EN-009-01	32-1048	137	EN-071	32-1161	140	EN-140-04	32-1375	146
DI-319	49-1213	265	DR-090	31-1005	132	DR-206	31-1126	132	EN-010	32-1058	136	EN-072	32-1162	140	EN-140-05	32-1245	143
DI-320	49-1151	265	DR-091	31-1006	132	DR-207	31-1127	132	EN-011	32-1054	136	EN-073	32-1165	140	EN-140-06	32-1377	146
DI-321	49-1152	265	DR-092	31-1007	132	DR-208	31-1128	132	EN-012	32-1041	137	EN-074	32-1166	140	EN-140-07	32-1378	146
DI-322	49-1156	265	DR-093	31-1008	132	DR-209	31-1129	132	EN-013	32-1042	137	EN-075	32-1167	140	EN-140-08	32-1379	146
DI-323	49-1157	265	DR-094	31-1009	132	DR-210	31-1130	132	EN-014	32-1051	136	EN-077	32-1461	146	EN-140-09	32-1380	146
DP-223	44-1201	242	DR-095	31-1010	132	DR-211	31-1131	132	EN-015	32-1052	136	EN-078	32-1462	146	EN-140-10	32-1381	146
DP-235	44-1202	242	DR-096	31-1011	132	DR-212	31-1132	132	EN-016	32-1056	136	EN-079	32-1465	146	EN-140-11	32-1382	146
DP-236	44-1203	242	DR-097	31-1012	132	DR-213	31-1133	132	EN-017	32-1057	136	EN-080	32-1466	146	EN-140-12	32-1383	146
DP-241	44-1212	242	DR-098	31-1013	132	DR-214	31-1134	132	EN-018	32-1055	136	EN-080-01	32-1471	146	EN-142	32-1246	143
DP-243	44-1213	242	DR-099	31-1014	132	DR-215	31-1135	132	EN-018-01	32-1053	136	EN-081	32-1354	145	EN-142-01	32-1384	146
DP-246	44-1215	242	DR-100	31-1015	132	DR-216	31-1136	132	EN-019	32-1043	137	EN-081-01	32-1351	145	EN-150	32-1131	139
DP-253	44-1221	242	DR-101	31-1016	132	DR-217	31-1137	132	EN-020	32-1031	137	EN-081-02	32-1355	145	EN-151	32-1132	139
DP-256	44-1225	242	DR-102	31-1017	132	DR-218	31-1138	132	EN-020-02	32-1013	136	EN-081-03	32-1358	145	EN-152	32-1133	139
DP-257	44-1231	242	DR-103	31-1018	132	DR-219	31-1139	132	EN-022	32-1011	136	EN-081-04	32-1359	145	EN-153	32-1134	139
DP-258	44-1241	242	DR-104	31-1019	132	DR-220	31-1140	132	EN-022-01	32-1012	136	EN-082	32-1211	142	EN-154	32-1135	139
DP-259	44-1251	242	DR-105	31-1020	132	DR-221	31-1141	132	EN-023	32-1014	136	EN-083	32-1215	142	EN-155	32-1141	139
DP-301	44-1261	242	DR-106	31-1021	132	DR-222	31-1142	132	EN-024	32-1015	136	EN-084	32-1217	142	EN-156	32-1142	139
DP-310	44-1262	242	DR-107	31-1022	132	DR-223	31-1143	132	EN-024-01	32-1016	136	EN-085	32-1219	142	EN-157	32-1143	139
DP-320	44-1263	242	DR-108	31-1023	132	DR-235	31-1025	132	EN-024-02	32-1017	136	EN-085-01	32-1190	141	EN-158	32-1144	139
DP-330	44-1267	242	DR-110	31-1046	132	DR-236	31-1026	132	EN-024-04	32-1018	136	EN-086	32-1034	137	EN-159	32-1145	139
DP-340	44-1271	242	DR-150	31-1250	132	DR-237	31-1027	132	EN-024-05	32-1019	136	EN-087	32-1035	137	EN-161	32-1121	139
DP-341	44-1272	242	DR-151	31-1251	132	DR-238	31-1028	132	EN-025	32-1071	138	EN-088	32-1038	137	EN-162	32-1122	139
DP-342	44-1281	242	DR-152	31-1252	132	DR-239	31-1029	132	EN-026	32-1111	139	EN-089	32-1039	137	EN-163	32-1123	139
DP-345	44-1291	242	DR-153	31-1253	132	DR-240	31-1030	132	EN-028	32-1092	139	EN-092	32-1311	144	EN-164	32-1124	139
DP-347	44-1292	242	DR-154	31-1254	132	DR-241	31-1031	132	EN-029	32-1093	139	EN-093	32-1312	144	EN-165	32-1146	139
DP-348	44-1293	242	DR-155	31-1255	132	DR-242	31-1032	132	EN-030	32-1094	139	EN-096	32-1317	144	EN-300	32-1151	140
DP-352	44-1301	242	DR-156	31-1256	132	DR-243	31-1033	132	EN-031	32-1095	139	EN-097	32-1318	144	EN-305	32-1154	140
DP-353	44-1303	242	DR-157	31-1257	132	DR-244	31-1034	132	EN-032	32-1096	139	EN-100	32-1301	144	EP-001	49-1221	266
DP-355	44-1311	242	DR-158	31-1258	132	DR-245	31-1035	132	EN-033	32-1097	139	EN-101	32-1302	144	EP-002	49-1222	266
DR-019	31-1191	133	DR-159	31-1259	132	DR-246	31-1036	132	EN-034	32-1098	139	EN-102	32-1314	144	EP-003	49-1223	266
DR-020	31-1192	133	DR-160	31-1260	132	DR-247	31-1037	132	EN-035	32-1072	138	EN-103	32-1315	144	EP-005	49-1236	266
DR-021	31-1193	133	DR-161	31-1261	132	DR-248	31-1038	132	EN-036	32-1073	138	EN-104	32-1344	145	EP-007	49-1225	266
DR-050	31-1150	132	DR-162	31-1262	132	DR-249	31-1039	132	EN-037	32-1074	138	EN-104-01	32-1341	145	EP-008	49-1226	266
DR-051	31-1151	132	DR-163	31-1263	132	DR-250	31-1040	132	EN-043	32-1112	139	EN-104-02	32-1342	145	EP-009	49-1235	266
DR-052	31-1152	132	DR-164	31-1264	132	DR-251	31-1041	132	EN-044	32-1113	139	EN-105	32-1345	145	FC-001	33-1296	156
DR-053	31-1153	132	DR-165	31-1265	132	DR-252	31-1042	132	EN-045	32-1114	139	EN-106	32-1347	145	FL-001	33-1391	156
DR-054	31-1154	132	DR-166	31-1266	132	DR-253	31-1043	132	EN-047	32-1080	138	EN-107	32-1348	145	FL-002	33-1393	156
DR-055	31-1155	132	DR-167	31-1267	132	DT-308	44-1026	241	EN-048	32-1081	138	EN-108	32-1321	144	FL-002-01	33-1392	156
DR-056	31-1156	132	DR-168	31-1268	132	DT-310	44-1027	241	EN-049	32-1082	138	EN-109	32-1322	144	FL-003	33-1397	156
DR-057	31-1157	132	DR-169	31-1269	132	DT-311	44-1021	241	EN-050	32-1083	138	EN-110	32-1323	144	FL-004	33-1398	156
DR-058	31-1158	132	DR-170	31-1270	132	DT-368	44-1022	241	EN-051	32-1084	138	EN-111	32-1324	144	FL-006	33-1399	156
DR-059	31-1159	132	DR-171	31-1271	132	DT-370	44-1023	241	EN-052	32-1085	138	EN-112	32-1328	144	FL-007	33-1168	151
DR-060	31-1160	132	DR-172	31-1272	132	EN-001	23-1083	42	EN-053	32-1086	138	EN-112-01	32-1327	144	FL-008	33-1169	151
DR-061	31-1161	132	DR-173	31-1273	132	EN-002	32-1148	139	EN-054	32-1087	138	EN-112-02	32-1329	144	FL-010	33-1281	156
DR-062	31-1162	132	DR-174	31-1274	132	EN-002-01	32-1149	139	EN-054-01	32-1088	138	EN-112-03	32-1330	144	FL-011	33-1282	156
DR-063	31-1163	132	DR-175	31-1275	132	EN-003	23-1351	49	EN-055	32-1204	142	EN-112-05	32-1326	144	FL-012	33-1283	156
DR-064	31-1164	132	DR-176	31-1276	132	EN-003-01	23-1352	49	EN-056	32-1201	142	EN-112-06	32-1325	144	FL-013	33-1284	156
DR-065	31-1165	132	DR-177	31-1277	132	EN-003-05	32-1271	143	EN-057	32-1225	142	EN-112-07	32-1331	144	FL-014	33-1285	156
DR-066	31-1166	132	DR-178	31-1278	132	EN-003-06	32-1272	143	EN-064	32-1213	142	EN-113	32-1332	144	FL-015	33-1291	156
DR-067	31-1167	132	DR-179	31-1279	132	EN-003-07	32-1273	143	EN-065	32-1185	141	EN-114	37-1781	180	FL-015-01	33-1292	156
DR-068	31-1168	132	DR-180	31-1280	132	EN-003-08	32-1274	143	EN-065-01	32-1223	142	EN-115	37-1782	180	FL-015-02	33-1293	156
DR-069	31-1169	132	DR-188	30-1471	129	EN-003-09	32-1277	234	EN-065-02	32-1189	141	EN-116	37-1783	180	FL-016	33-1241	151
DR-070	31-1170	132	DR-189	30-1472	129	EN-003-10	32-1278	234	EN-065-03	32-1187	141	EN-117	37-1691	178	FL-020	33-1242	151
DR-071	31-1171	132	DR-190	30-1473	129	EN-003-11	32-1279	234	EN-066	32-1179	141	EN-118	37-1692	178	FL-023	33-1251	151
DR-072	31-1172	132	DR-191	30-1474	129	EN-004	23-1353	49	EN-066-01	32-1221	142	EN-118-01	37-1797	180	FL-024	33-1252	151
DR-073	31-1173	132	DR-192	30-1475	129	EN-005	32-1243	143	EN-066-02	32-1181	141	EN-118-02	37-1798	180	FL-025	33-1253	151

OLD # TO NEW



OLD #	NEW #	PG#	OLD #	NEW #	PG#	OLD #	NEW #	PG#	OLD #	NEW #	PG#	OLD #	NEW #	PG#	OLD #	NEW #	PG#
FL-025-01	33-1255	151	FL-165	33-1087	149	FL-302	33-1483	156	FL-445	33-1344	152	FL-528	33-1437	153	GH-036	37-1038	176
FL-025-02	33-1256	151	FL-166	33-1088	149	FL-303	33-1484	156	FL-446	33-1345	152	FL-529	33-1438	153	GH-037	37-1039	176
FL-025-03	33-1257	151	FL-167	33-1089	149	FL-310	33-1171	150	FL-451	33-1351	153	FL-531	33-1491	156	GH-038	37-1040	176
FL-030	33-1147	151	FL-168	33-1090	149	FL-312	33-1172	150	FL-452	33-1352	153	FL-532	33-1492	156	GH-039	37-1041	176
FL-031	33-1148	151	FL-169	33-1102	149	FL-313	33-1175	150	FL-453	33-1353	153	FL-535	33-1441	154	GH-040	37-1042	176
FL-033	33-1149	151	FL-170	33-1103	149	FL-314	33-1178	150	FL-454	33-1354	153	FL-536	33-1442	154	GH-041	37-1043	176
FL-034	33-1162	151	FL-171	33-1104	149	FL-315	33-1181	150	FL-456	33-1401	153	FL-537	33-1443	154	GH-042	37-1044	176
FL-035	33-1163	151	FL-172	33-1105	149	FL-316	33-1183	150	FL-457	33-1402	153	FL-538	33-1444	154	GH-043	37-1045	176
FL-037	33-1142	151	FL-173	33-1122	149	FL-317	33-1173	150	FL-458	33-1403	153	FL-539	33-1445	154	GH-045	37-1120	176
FL-039	33-1143	151	FL-174	33-1123	149	FL-318	33-1176	150	FL-459	33-1404	153	FL-540	33-1446	154	GH-046	37-1121	176
FL-041	33-1144	151	FL-175	33-1124	149	FL-319	33-1179	150	FL-461	33-1355	153	FL-541	33-1447	154	GH-047	37-1122	176
FL-042	33-1145	151	FL-177	33-1107	149	FL-320	33-1182	150	FL-462	33-1356	153	FL-545	33-1452	155	GH-048	37-1123	176
FL-044	33-1146	151	FL-178	33-1108	149	FL-321	33-1184	150	FL-463	33-1357	153	FL-546	33-1453	155	GH-049	37-1124	176
FL-046	33-1151	151	FL-179	33-1109	149	FL-327	33-1201	150	FL-464	33-1358	153	FL-549	33-1455	155	GH-050	37-1125	176
FL-047	33-1152	151	FL-180	33-1127	149	FL-328	33-1204	150	FL-466	33-1405	153	FL-550	33-1456	155	GH-051	37-1126	176
FL-049	33-1153	151	FL-181	33-1128	149	FL-329	33-1214	150	FL-467	33-1406	153	FL-553	33-1458	155	GH-052	37-1127	176
FL-051	33-1165	151	FL-182	33-1129	149	FL-329-01	33-1217	150	FL-468	33-1407	153	FL-554	33-1459	155	GH-053	37-1128	176
FL-052	33-1166	151	FL-184	33-1117	149	FL-330	33-1211	150	FL-469	33-1408	153	FL-556	33-1460	155	GH-054	37-1129	176
FL-054	33-1154	151	FL-185	33-1120	149	FL-331	33-1207	150	FL-471	33-1361	153	FL-557	33-1461	155	GH-055	37-1130	176
FL-055	33-1155	151	FL-186	33-1118	149	FL-332	33-1212	150	FL-472	33-1362	153	FL-558	33-1462	155	GH-059	37-1091	176
FL-056	33-1156	151	FL-187	33-1119	149	FL-333	33-1215	150	FL-473	33-1363	153	FL-560	33-1463	155	GH-060	37-1092	176
FL-059	33-1157	151	FL-188	33-1132	149	FL-334	33-1218	150	FL-474	33-1364	153	FL-561	33-1464	155	GH-061	37-1093	176
FL-060	33-1158	151	FL-189	33-1133	149	FL-335	33-1205	150	FL-476	33-1411	153	FL-562	33-1465	155	GH-063	37-1060	176
FL-062	33-1159	151	FL-190	33-1134	149	FL-336	33-1202	150	FL-477	33-1412	153	FL-563	33-1466	155	GH-064	37-1061	176
FL-080	33-1261	151	FL-192	33-1112	149	FL-337	33-1208	150	FL-478	33-1413	153	FL-564	33-1467	155	GH-065	37-1062	176
FL-081	33-1262	151	FL-193	33-1113	149	FL-338	33-1213	150	FL-479	33-1414	153	FL-565	33-1468	155	GH-066	37-1063	176
FL-082	33-1263	151	FL-194	33-1114	149	FL-339	33-1216	150	FL-481	33-1365	153	FL-568	33-1470	155	GH-067	37-1064	176
FL-083	33-1264	151	FL-195	33-1137	149	FL-340	33-1219	150	FL-482	33-1366	153	FL-569	33-1471	155	GH-068	37-1065	176
FL-084	33-1265	151	FL-196	33-1138	149	FL-341	33-1206	150	FL-483	33-1367	153	FL-573	33-1475	155	GH-070	37-1070	176
FL-085	33-1266	151	FL-197	33-1139	149	FL-342	33-1203	150	FL-484	33-1368	153	FL-574	33-1476	155	GH-071	37-1071	176
FL-099	33-1051	149	FL-199	33-1011	148	FL-343	33-1209	150	FL-486	33-1415	153	FL-580	33-1448	154	GH-072	37-1072	176
FL-100	33-1052	149	FL-200	33-1012	148	FL-350	33-1221	150	FL-487	33-1416	153	FL-581	33-1449	154	GH-073	37-1073	176
FL-101	33-1053	149	FL-201	33-1013	148	FL-351	33-1222	150	FL-488	33-1417	153	FL-582	33-1450	154	GH-074	37-1074	176
FL-102	33-1054	149	FL-202	33-1014	148	FL-352	33-1223	150	FL-489	33-1418	153	GH-001	37-1008	176	GH-075	37-1075	176
FL-103	33-1055	149	FL-203	33-1015	148	FL-401	33-1301	152	FL-491	33-1371	153	GH-002	37-1009	176	GH-076	37-1076	176
FL-116	33-1071	149	FL-208	33-1016	148	FL-402	33-1302	152	FL-492	33-1372	153	GH-003	37-1010	176	GH-077	37-1077	176
FL-117	33-1072	149	FL-209	33-1017	148	FL-403	33-1303	152	FL-493	33-1373	153	GH-004	37-1011	176	GH-078	37-1078	176
FL-118	33-1073	149	FL-210	33-1018	148	FL-404	33-1304	152	FL-494	33-1374	153	GH-005	37-1012	176	GH-079	37-1079	176
FL-119	33-1074	149	FL-211	33-1019	148	FL-405	33-1305	152	FL-496	33-1421	153	GH-006	37-1013	176	GH-080	37-1080	176
FL-120	33-1075	149	FL-212	33-1020	148	FL-408	33-1306	152	FL-497	33-1422	153	GH-007	37-1014	176	GH-091	37-1111	176
FL-131	33-1056	149	FL-218	33-1021	148	FL-409	33-1307	152	FL-498	33-1423	153	GH-008	37-1015	176	GH-092	37-1112	176
FL-132	33-1057	149	FL-219	33-1022	148	FL-410	33-1308	152	FL-499	33-1424	153	GH-009	37-1016	176	GH-093	37-1113	176
FL-133	33-1058	149	FL-220	33-1023	148	FL-411	33-1309	152	FL-501	33-1375	153	GH-011	37-1020	176	GH-123	37-1198	176
FL-134	33-1059	149	FL-221	33-1024	148	FL-412	33-1310	152	FL-502	33-1376	153	GH-012	37-1021	176	GH-124	37-1199	176
FL-135	33-1060	149	FL-224	33-1025	148	FL-415	33-1311	152	FL-503	33-1377	153	GH-013	37-1022	176	GH-125	37-1200	176
FL-148	33-1076	149	FL-230	33-1027	148	FL-416	33-1312	152	FL-504	33-1378	153	GH-014	37-1023	176	GH-126	37-1201	176
FL-149	33-1077	149	FL-231	33-1028	148	FL-417	33-1313	152	FL-506	33-1425	153	GH-015	37-1024	176	GH-127	37-1202	176
FL-150	33-1078	149	FL-232	33-1029	148	FL-418	33-1314	152	FL-507	33-1426	153	GH-017	37-1050	176	GH-128	37-1203	176
FL-151	33-1079	149	FL-238	33-1031	148	FL-419	33-1315	152	FL-508	33-1427	153	GH-018	37-1051	176	GH-129	37-1204	176
FL-152	33-1080	149	FL-239	33-1032	148	FL-421	33-1317	152	FL-509	33-1428	153	GH-019	37-1052	176	GH-130	37-1205	176
FL-152-99	33-1066	149	FL-240	33-1033	148	FL-422	33-1319	152	FL-511	33-1381	153	GH-020	37-1053	176	GH-132	37-1210	176
FL-153	33-1067	149	FL-241	33-1034	148	FL-423	33-1320	152	FL-512	33-1382	153	GH-021	37-1054	176	GH-133	37-1211	176
FL-154	33-1068	149	FL-242	33-1035	148	FL-426	33-1321	152	FL-513	33-1383	153	GH-022	37-1055	176	GH-134	37-1212	176
FL-155	33-1069	149	FL-250	33-1037	148	FL-427	33-1322	152	FL-514	33-1384	153	GH-023	37-1056	176	GH-135	37-1213	176
FL-156	33-1070	149	FL-251	33-1038	148	FL-428	33-1323	152	FL-516	33-1431	153	GH-024	37-1057	176	GH-136	37-1214	176
FL-156-01	33-1081	149	FL-252	33-1039	148	FL-429	33-1324	152	FL-517	33-1432	153	GH-025	37-1058	176	GH-137	37-1250	176
FL-157	33-1082	149	FL-254	33-1042	148	FL-430	33-1325	152	FL-518	33-1433	153	GH-026	37-1059	176	GH-138	37-1251	176
FL-158	33-1083	149	FL-255	33-1043	148	FL-434	33-1329	152	FL-519	33-1434	153	GH-028	37-1143	176	GH-139	37-1252	176
FL-159	33-1084	149	FL-256	33-1044	148	FL-435	33-1330	152	FL-521	33-1385	153	GH-029	37-1144	176	GH-140	37-1253	176
FL-160	33-1085	149	FL-258	33-1047	148	FL-437	33-1334	152	FL-522	33-1386	153	GH-030	37-1145	176	GH-141	37-1254	176
FL-161	33-1062	149	FL-259	33-1048	148	FL-438	33-1335	152	FL-523	33-1387	153	GH-031	37-1146	176	GH-142	37-1255	176
FL-162	33-1063	149	FL-260	33-1049	148	FL-440	33-1339	152	FL-524	33-1388	153	GH-032	37-1147	176	GH-143	37-1256	176
FL-163	33-1064	149	FL-300	33-1481	156	FL-441	33-1340	152	FL-526	33-1435	153	GH-034	37-1036	176	GH-144	37-1257	176
FL-164	33-1065	149	FL-301	33-1482	156	FL-444	33-1342	152	FL-527	33-1436	153	GH-035	37-1037	176	GH-145	37-1258	176



OLD # TO NEW#

OLD #	NEW #	PG#	OLD #	NEW #	PG#	OLD #	NEW #	PG#	OLD #	NEW #	PG#	OLD #	NEW #	PG#	OLD #	NEW #	PG#
GH-146	37-1259	176	GH-212	32-1404	146	GH-406	37-1426	178	GH-642	37-1542	179	GH-757	37-1757	180	GH-851	37-1851	182
GH-151	37-1236	176	GH-215	37-1346	177	GH-407	37-1427	178	GH-643	37-1543	179	GH-758	37-1758	180	GH-852	37-1852	182
GH-152	37-1237	176	GH-216	37-1347	177	GH-408	37-1428	178	GH-644	37-1544	179	GH-759	37-1759	180	GH-853	37-1853	182
GH-153	37-1238	176	GH-217	37-1348	177	GH-436	37-1436	178	GH-645	37-1545	179	GH-760	37-1760	180	GH-854	37-1854	182
GH-154	37-1239	176	GH-218	37-1349	177	GH-437	37-1437	178	GH-646	37-1546	179	GH-761	37-1761	180	GH-855	37-1855	182
GH-155	37-1240	176	GH-219	37-1350	177	GH-438	37-1438	178	GH-647	37-1547	179	GH-762	37-1762	180	GH-856	37-1856	182
GH-156	37-1241	176	GH-220	37-1351	177	GH-439	37-1439	178	GH-648	37-1548	179	GH-763	37-1763	180	GH-857	37-1857	182
GH-157	37-1242	176	GH-221	37-1352	177	GH-440	37-1440	178	GH-649	37-1549	179	GH-770	37-1770	180	GH-858	37-1858	182
GH-158	37-1243	176	GH-222	37-1353	177	GH-441	37-1441	178	GH-650	37-1550	179	GH-771	37-1771	180	GH-859	37-1859	182
GH-159	37-1244	176	GH-223	37-1354	177	GH-442	37-1442	178	GH-651	37-1551	179	GH-772	37-1772	180	GH-860	37-1860	182
GH-160	37-1245	176	GH-224	37-1355	177	GH-443	37-1443	178	GH-652	37-1552	179	GH-773	37-1773	180	GH-861	37-1861	182
GH-170	37-1260	176	GH-225	37-1356	177	GH-444	37-1444	178	GH-653	37-1553	179	GH-774	37-1774	180	GH-862	37-1862	182
GH-171	37-1261	176	GH-226	37-1357	177	GH-445	37-1445	178	GH-654	37-1554	179	GH-775	37-1775	180	GH-863	37-1863	182
GH-172	37-1262	176	GH-227	37-1358	177	GH-446	37-1446	178	GH-655	37-1555	179	GH-776	37-1776	180	GH-865	37-1966	182
GH-173	37-1263	176	GH-230	37-1362	177	GH-447	37-1447	178	GH-656	37-1556	179	GH-777	37-1777	180	GH-866	37-1967	182
GH-179	37-2051	181	GH-231	37-1364	177	GH-448	37-1448	178	GH-657	37-1557	179	GH-792	37-1792	180	GH-867	37-1968	182
GH-180	37-2052	181	GH-232	37-1366	177	GH-449	37-1449	178	GH-658	37-1558	179	GH-793	37-1793	180	GH-868	37-1969	182
GH-180-01	37-2053	181	GH-232-01	37-1368	177	GH-450	37-1450	178	GH-659	37-1559	179	GH-794	37-1588	179	GH-869	37-1970	182
GH-181	37-2111	177	GH-233	37-1370	177	GH-451	37-1451	178	GH-660	37-1560	179	GH-794-01	37-1594	179	GH-870	37-1971	182
GH-182	37-2112	177	GH-234	37-1372	177	GH-452	37-1452	178	GH-661	37-1561	179	GH-794-02	37-1596	179	GH-871	37-1972	182
GH-183	37-2113	177	GH-235	37-1374	177	GH-453	37-1453	178	GH-662	37-1562	179	GH-794-03	37-1618	179	GH-872	37-1973	182
GH-184	37-2114	177	GH-236	37-1376	177	GH-454	37-1454	178	GH-663	37-1563	179	GH-794-04	37-1620	179	GH-873	37-1974	182
GH-184-01	37-2118	177	GH-237	37-1378	177	GH-455	37-1455	178	GH-670	37-1570	179	GH-794-05	37-1624	179	GH-874	37-1975	182
GH-185	37-2121	177	GH-238	37-1380	177	GH-456	37-1456	178	GH-671	37-1571	179	GH-795	37-1634	179	GH-875	37-1976	182
GH-186	37-2122	177	GH-240	37-1382	177	GH-457	37-1457	178	GH-672	37-1572	179	GH-795-01	37-1636	179	GH-876	37-1977	182
GH-186-01	37-2123	177	GH-241	37-1384	177	GH-458	37-1458	178	GH-673	37-1573	179	GH-795-02	37-1638	179	GH-877	37-1978	182
GH-187	37-2124	177	GH-242	37-1386	177	GH-459	37-1459	178	GH-674	37-1574	179	GH-795-03	37-1640	179	GH-880	37-1980	182
GH-187-01	37-2143	177	GH-242-01	37-1388	177	GH-460	37-1460	178	GH-675	37-1575	179	GH-795-04	37-1644	179	GH-881	37-1981	182
GH-187-02	37-2142	177	GH-243	37-1390	177	GH-461	37-1461	178	GH-676	37-1576	179	GH-810	37-1866	182	GH-882	37-1982	182
GH-188	37-2144	177	GH-244	37-1392	177	GH-462	37-1462	178	GH-677	37-1577	179	GH-811	37-1867	182	GH-883	37-1983	182
GH-188-01	37-2145	177	GH-245	37-1394	177	GH-463	37-1463	178	GH-696	37-1696	180	GH-812	37-1868	182	GH-884	37-1984	182
GH-188-02	37-2147	177	GH-245-01	37-1396	177	GH-470	37-1470	178	GH-697	37-1697	180	GH-813	37-1869	182	GH-885	37-1985	182
GH-189	37-2154	177	GH-246	37-1398	177	GH-471	37-1471	178	GH-698	37-1698	180	GH-814	37-1870	182	GH-886	37-1986	182
GH-189-01	37-2164	177	GH-246-01	37-1400	177	GH-472	37-1472	178	GH-699	37-1699	180	GH-815	37-1871	182	GH-887	37-1987	182
GH-189-02	37-2168	177	GH-248	37-1401	177	GH-473	37-1473	178	GH-700	37-1700	180	GH-816	37-1872	182	GH-890	37-1936	182
GH-189-03	37-2170	177	GH-249	37-1402	177	GH-474	37-1474	178	GH-701	37-1701	180	GH-817	37-1873	182	GH-891	37-1937	182
GH-189-04	37-2172	177	GH-250	37-1403	177	GH-475	37-1475	178	GH-702	37-1702	180	GH-818	37-1874	182	GH-892	37-1938	182
GH-189-05	37-2176	177	GH-253	37-2031	181	GH-476	37-1476	178	GH-703	37-1703	180	GH-819	37-1875	182	GH-893	37-1939	182
GH-189-07	37-2184	177	GH-254	37-2032	181	GH-477	37-1477	178	GH-704	37-1704	180	GH-820	37-1876	182	GH-894	37-1940	182
GH-189-08	37-2186	177	GH-256	37-2033	181	GH-525	37-1675	178	GH-705	37-1705	180	GH-821	37-1877	182	GH-895	37-1941	182
GH-189-09	37-2188	177	GH-258	37-2034	181	GH-526	37-1676	178	GH-706	37-1706	180	GH-822	37-1878	182	GH-896	37-1942	182
GH-189-10	37-2190	177	GH-259	37-2035	181	GH-580	37-1680	178	GH-707	37-1707	180	GH-825	37-1880	182	GH-897	37-1943	182
GH-189-11	37-2192	177	GH-260	37-2036	181	GH-581	37-1681	178	GH-708	37-1708	180	GH-826	37-1881	182	GH-898	37-1944	182
GH-189-13	37-2210	177	GH-261	37-2037	181	GH-582	37-1682	179	GH-736	37-1736	180	GH-827	37-1882	182	GH-899	37-1945	182
GH-189-15	37-2216	177	GH-262	37-2038	181	GH-583	37-1683	179	GH-737	37-1737	180	GH-828	37-1883	182	GH-900	37-1946	182
GH-189-16	37-2218	177	GH-263	37-2045	181	GH-596	37-1496	179	GH-738	37-1738	180	GH-829	37-1884	182	GH-901	37-1947	182
GH-189-18	37-2220	177	GH-264	37-2046	181	GH-597	37-1497	179	GH-739	37-1739	180	GH-830	37-1885	182	GH-902	37-1948	182
GH-189-20	37-2230	177	GH-267	37-2011	181	GH-598	37-1498	179	GH-740	37-1740	180	GH-831	37-1886	182	GH-903	37-1949	182
GH-189-22	37-2240	177	GH-268	37-2016	178	GH-599	37-1499	179	GH-741	37-1741	180	GH-832	37-1887	182	GH-910	37-1950	182
GH-189-24	37-2258	177	GH-351	37-2015	180	GH-600	37-1500	179	GH-742	37-1742	180	GH-835	37-1836	182	GH-911	37-1951	182
GH-190	37-2264	177	GH-354	37-2021	181	GH-601	37-1501	179	GH-743	37-1743	180	GH-836	37-1837	182	GH-912	37-1952	182
GH-190-01	37-2266	177	GH-354-01	37-2022	181	GH-602	37-1502	179	GH-744	37-1744	180	GH-837	37-1838	182	GH-913	37-1953	182
GH-190-02	37-2268	177	GH-354-02	37-2023	181	GH-603	37-1503	179	GH-745	37-1745	180	GH-838	37-1839	182	GH-914	37-1954	182
GH-190-03	37-2270	177	GH-357	37-2041	181	GH-604	37-1504	179	GH-746	37-1746	180	GH-839	37-1840	182	GH-915	37-1955	182
GH-190-04	37-3251	177	GH-396	37-1416	178	GH-605	37-1505	179	GH-747	37-1747	180	GH-840	37-1841	182	GH-916	37-1956	182
GH-190-05	37-3252	177	GH-397	37-1417	178	GH-606	37-1506	179	GH-748	37-1748	180	GH-841	37-1842	182	GH-917	37-1957	182
GH-190-06	37-3253	177	GH-398	37-1418	178	GH-607	37-1507	179	GH-749	37-1749	180	GH-842	37-1843	182	GH-918	37-1958	182
GH-201	32-1411	146	GH-399	37-1419	178	GH-608	37-1508	179	GH-750	37-1750	180	GH-843	37-1844	182	GH-919	37-1959	182
GH-202	32-1412	146	GH-400	37-1420	178	GH-636	37-1536	179	GH-751	37-1751	180	GH-844	37-1845	182	GH-920	37-1960	182
GH-203	32-1414	146	GH-401	37-1421	178	GH-637	37-1537	179	GH-752	37-1752	180	GH-845	37-1846	182	GH-921	37-1961	182
GH-204	32-1413	146	GH-402	37-1422	178	GH-638	37-1538	179	GH-753	37-1753	180	GH-846	37-1847	182	GH-922	37-1962	182
GH-207	32-1401	146	GH-403	37-1423	178	GH-639	37-1539	179	GH-754	37-1754	180	GH-847	37-1848	182	GH-923	37-1963	182
GH-208	32-1402	146	GH-404	37-1424	178	GH-640	37-1540	179	GH-755	37-1755	180	GH-848	37-1849	182	GM-001	35-1073	168
GH-211	32-1403	146	GH-405	37-1425	178	GH-641	37-1541	179	GH-756	37-1756	180	GH-850	37-1850	182	GM-002	35-1092	169

OLD # TO NEW



OLD #	NEW #	PG#	OLD #	NEW #	PG#	OLD #	NEW #	PG#	OLD #	NEW #	PG#	OLD #	NEW #	PG#	OLD #	NEW #	PG#
GM-003	35-1093	169	GM-414	35-1173	129	HM-728	38-1024	184	HO-029	31-1210	133	IM-806	27-1341	100	LD-910	39-1432	193
GM-004	35-1077	168	GM-415	35-1176	129	HM-729	38-1020	184	HO-030	31-1211	133	IM-807	27-1342	100	LD-911	39-1433	193
GM-005	35-1071	168	GM-501	35-1161	167	HM-730	38-1022	184	HO-031	31-1212	133	IM-808	27-1343	100	LD-920	30-1261	120
GM-006	35-1078	168	GM-502	35-1162	167	HM-731	38-1023	184	HO-032	31-1213	133	LD-204	39-1398	195	LM-001	39-1211	192
GM-007	35-1074	168	GM-503	35-1165	167	HM-732	38-1019	184	HO-033	31-1214	133	LD-205	39-1399	195	LM-002	39-1212	192
GM-010	43-1048	232	GM-504	35-1166	167	HM-733	38-1017	184	HO-034	31-1215	133	LD-207	39-1271	193	LM-080	39-1081	191
GM-099	35-1091	169	GM-505	35-1168	167	HM-734	38-1018	184	HO-035	49-1019	262	LD-210	39-1272	193	LM-080-01	39-1083	191
GM-100	35-1082	169	GM-520-01	35-1159	165	HM-740-01	38-1047	185	HO-040	23-1286	50	LD-214	39-1273	193	LM-084	39-1084	191
GM-101	35-1084	170	GM-521	35-1151	165	HM-740-02	38-1044	185	HO-041	23-1287	50	LD-220	39-1274	193	LM-084-01	39-1086	191
GM-102	35-1085	170	GM-522	35-1155	165	HM-740-03	38-1054	185	HO-050	31-1321	134	LD-230	39-1276	193	LM-085	39-1087	191
GM-103	35-1086	170	GM-601	35-1042	166	HM-747	38-1045	185	HO-051	31-1322	134	LD-234	39-1277	193	LM-085-01	39-1088	191
GM-104	35-1087	170	GM-602	35-1141	168	HM-749	38-1042	185	HO-054	31-1331	134	LD-240	39-1278	193	LM-085-02	39-1089	191
GM-105	35-1081	169	GM-603	35-1147	168	HM-750	38-1041	185	HO-055	31-1332	134	LD-241	39-1261	192	LM-100	39-1020	190
GM-106	35-1088	169	GM-603-01	35-1148	168	HM-751	38-1048	185	HO-056	31-1333	134	LD-241-01	39-1262	192	LM-101	39-1011	190
GM-107	35-1089	169	GM-604	35-1157	165	HM-752	38-1051	185	HO-057	31-1334	134	LD-242	39-1263	192	LM-102	39-1021	190
GM-108	35-1123	170	GM-605	35-1142	168	HM-753	38-1052	185	HO-058	31-1335	134	LD-242-01	39-1264	192	LM-103	39-1012	190
GM-109	35-1121	170	GM-606	35-1146	168	HM-754	38-1049	185	HO-059	31-1336	134	LD-242-03	39-1266	192	LM-104	39-1022	190
GM-110	35-1125	170	GM-701	35-1016	164	HM-757	38-1053	185	HO-060	31-1337	134	LD-242-04	39-1267	192	LM-105	39-1013	190
GM-111	35-1126	170	HM-280	38-1161	187	HM-760	38-1043	185	HO-061	31-1338	134	LD-242-05	39-1268	192	LM-106	39-1023	190
GM-112	35-1124	170	HM-280-01	38-1061	187	HM-762	38-1046	185	HO-062	31-1339	134	LD-242-06	39-1269	192	LM-107	39-1014	190
GM-113	35-1122	170	HM-283	38-1302	187	HM-763	38-1055	185	HO-063	31-1340	134	LD-243	39-1295	196	LM-108	39-1024	190
GM-204	35-1011	164	HM-283-01	38-1301	187	HM-771	38-1050	185	HO-074	49-1033	262	LD-243-01	39-1296	196	LM-110	39-1015	190
GM-205	35-1014	164	HM-284	38-1321	188	HO-001	31-1201	133	HO-075	49-1031	262	LD-243-02	39-1297	196	LM-111	39-1025	190
GM-206	35-1012	164	HM-285	38-1322	188	HO-002	31-1202	133	HO-080	49-1251	265	LD-243-03	39-1298	196	LM-112	39-1016	190
GM-208	35-1013	164	HM-286	38-1323	188	HO-003	31-1203	133	HO-085	49-1254	265	LD-244	39-1294	193	LM-113	39-1026	190
GM-209	35-1023	164	HM-287	38-1324	188	HO-004	31-1204	133	HO-086	49-1255	265	LD-245	39-1290	193	LM-114	39-1017	190
GM-210	35-1021	164	HM-288	38-1325	188	HO-005	23-1064	47	HO-087	49-1256	265	LD-255	39-1251	192	LM-115	39-1027	190
GM-211	35-1026	164	HM-300	38-1311	188	HO-005-01	23-1065	47	HO-088	49-1257	265	LD-256	39-1252	192	LM-116	39-1018	190
GM-212	35-1027	164	HM-301	38-1312	188	HO-007	23-1063	47	HO-089	49-1258	265	LD-290	39-1291	193	LM-117	39-1028	190
GM-213	35-1024	164	HM-302	38-1313	188	HO-008	23-1059	42	HO-090	49-1259	265	LD-450	39-1411	196	LM-119	39-1009	192
GM-214	35-1022	164	HM-303	38-1314	188	HO-009	50-1015	268	HO-091	49-1261	265	LD-451	39-1412	196	LM-120	39-1031	190
GM-215	35-1028	164	HM-304	38-1315	188	HO-010	50-1031	45	HO-201	23-1261	46	LD-452	39-1413	196	LM-121	39-1041	190
GM-225	35-1017	168	HM-304-01	38-1121	187	HO-011	50-1032	45	HO-202	23-1262	46	LD-498	39-1356	195	LM-122	39-1032	190
GM-230	35-1018	168	HM-305	38-1122	187	HO-011-01	50-1027	269	HO-203	23-1263	46	LD-499	39-1357	195	LM-123	39-1042	190
GM-236	35-1039	167	HM-306	38-1126	187	HO-011-02	50-1028	269	HO-204	23-1264	46	LD-500	39-1358	195	LM-124	39-1035	190
GM-237	35-1036	167	HM-310	38-1127	187	HO-011-03	50-1029	269	HO-302	23-1061	47	LD-501	39-1361	195	LM-125	39-1045	190
GM-238	35-1037	167	HM-312-99	38-1066	187	HO-012	50-1034	269	HO-306	49-1159	265	LD-503	39-1366	195	LM-126	39-1036	190
GM-239	35-1034	166	HM-313	38-1067	187	HO-013	50-1016	268	HO-401	55-1292	305	LD-503-01	39-1367	195	LM-127	39-1046	190
GM-240	35-1035	167	HM-314	38-1068	187	HO-014	50-1041	269	HO-402	55-1293	305	LD-505	39-1351	195	LM-128	39-1040	190
GM-241	35-1038	167	HM-315	38-1069	187	HO-014-01	50-1044	269	HO-409	23-1211	45	LD-506	39-1352	195	LM-129	39-1051	190
GM-295	35-1054	166	HM-317	38-1331	188	HO-015	50-1042	269	HO-410	23-1212	45	LD-506-01	39-1368	195	LM-129-01	39-1052	190
GM-296	35-1055	166	HM-318	38-1332	188	HO-015-01	50-1043	269	HO-411	23-1214	45	LD-510	39-1421	193	LM-129-02	39-1061	190
GM-297	35-1057	166	HM-319	38-1333	188	HO-015-02	50-1046	269	HO-412	23-1221	45	LD-514	39-1422	193	LM-129-03	39-1062	190
GM-298	35-1058	166	HM-319-05	38-1339	188	HO-015-03	50-1047	269	HO-413	23-1222	45	LD-520	39-1423	193	LM-129-04	39-1065	190
GM-299	35-1060	166	HM-320	38-1306	187	HO-015-04	50-1048	269	HO-414	23-1223	45	LD-662	39-1311	194	LM-129-05	39-1066	190
GM-300	35-1068	166	HM-321	38-1307	187	HO-016	50-1051	269	HO-415	23-1224	45	LD-663	39-1312	194	LM-129-11	39-1071	191
GM-301	35-1051	166	HM-700	38-1165	187	HO-016-01	50-1052	269	HO-416	23-1225	45	LD-667	39-1313	194	LM-129-12	39-1072	191
GM-302	35-1052	166	HM-705	38-1166	187	HO-017	49-1011	260	HO-417	23-1213	45	LD-668	39-1314	194	LM-129-13	39-1073	191
GM-303	35-1061	167	HM-706	38-1167	187	HO-018	31-1312	134	HO-418	23-1216	45	LD-702	39-1321	194	LM-129-14	39-1074	191
GM-304	35-1062	167	HM-706-01	38-1064	187	HO-019	31-1311	134	HO-419	23-1215	45	LD-703	39-1322	194	LM-129-15	39-1075	191
GM-305	35-1047	167	HM-710	38-1357	188	HO-019-01	31-1313	134	HO-421	23-1217	45	LD-707	39-1323	194	LM-129-16	39-1076	191
GM-306	35-1048	167	HM-712	38-1341	188	HO-021	23-1058	42	IM-703	27-1328	100	LD-708	39-1324	194	LM-129-17	39-1077	191
GM-307	35-1045	165	HM-713	38-1342	188	HO-022	31-1316	134	IM-704	27-1327	100	LD-713	39-1341	194	LM-129-18	39-1078	191
GM-308	35-1063	167	HM-714	38-1343	188	HO-023	50-1066	270	IM-705	27-1336	100	LD-721	39-1342	194	LM-130	59-1766	342
GM-386	31-1995	133	HM-715	38-1344	188	HO-023-01	50-1067	270	IM-706	27-1335	100	LD-762	39-1316	194	LM-131	59-1767	342
GM-387	31-1996	133	HM-716	38-1345	188	HO-023-12	50-1021	45	IM-710	27-1337	100	LD-763	39-1317	194	LM-132	59-1768	342
GM-390	35-1032	165	HM-720	38-1011	184	HO-023-13	50-1022	45	IM-720	27-1338	100	LD-767	39-1318	194	LM-134	39-1201	192
GM-401	35-1044	165	HM-721	38-1012	184	HO-023-14	50-1023	45	IM-725	27-1339	100	LD-768	39-1319	194	LM-135	39-1202	192
GM-402	35-1041	166	HM-722	38-1013	184	HO-023-15	50-1024	45	IM-780	27-1321	100	LD-901	39-1329	194	LM-136	39-1203	192
GM-403	35-1049	167	HM-723	38-1014	184	HO-023-16	50-1025	45	IM-790	27-1322	100	LD-902	39-1325	194	LM-140	39-1091	191
GM-410	35-1171	128	HM-724	38-1015	184	HO-025	31-1206	133	IM-800	27-1323	100	LD-903	39-1326	194	LM-141	39-1092	191
GM-411	35-1175	129	HM-725	38-1016	184	HO-026	31-1207	133	IM-802	27-1324	100	LD-907	39-1327	194	LM-142	39-1093	191
GM-412	35-1172	129	HM-726	38-1025	184	HO-027	31-1208	133	IM-803	27-1331	100	LD-908	39-1328	194	LM-145	39-2019	50
GM-413	35-1174	129	HM-727	38-1021	184	HO-028	31-1209	133	IM-804	27-1332	100	LD-909	39-1431	193	LM-145-01	39-2021	50



OLD # TO NEW#

OLD #	NEW #	PG#	OLD #	NEW #	PG#	OLD #	NEW #	PG#	OLD #	NEW #	PG#	OLD #	NEW #	PG#	OLD #	NEW #	PG#
LS-203	39-1671	198	LS-422	39-1511	197	MG-354-01	43-1185	236	MO-083-01	34-1023	158	MO-333	34-1215	161	PC-054	42-1055	224
LS-204	39-1672	198	LS-423	39-1512	197	MG-355	43-1146	236	MO-083-02	34-1024	158	MO-401	34-1291	159	PC-055	42-1056	224
LS-205	39-1673	198	LS-424	39-1513	197	MG-355-01	43-1186	236	MO-084	34-1026	158	MO-402	34-1292	159	PC-056	42-1057	224
LS-207	39-1674	198	LS-425	39-1514	197	MG-356	43-1147	236	MO-134	34-1035	158	MO-403	34-1293	159	PC-058	42-1011	224
LS-235	39-1675	198	LS-427	39-1515	197	MG-356-01	43-1187	236	MO-135	34-1036	158	MO-405	34-1065	160	PC-060	42-1025	224
LS-247	39-1676	198	LS-430	39-1516	197	MG-357	43-1148	236	MO-136	34-1031	158	MO-406	34-1066	160	PC-061	42-1016	224
LS-249	39-1661	198	LS-432	39-1531	197	MG-357-01	43-1188	236	MO-137	34-1032	158	MO-408	34-1171	161	PC-062	42-1026	224
LS-250	39-1662	198	LS-433	39-1532	197	MG-358	43-1149	236	MO-143	34-1251	159	MO-409	34-1173	161	PC-063	42-1071	225
LS-251	39-1663	198	LS-434	39-1533	197	MG-358-01	43-1189	236	MO-147	34-1252	159	MO-409-01	34-1153	161	PC-064	42-1072	225
LS-252	39-1664	198	LS-435	39-1534	197	MG-359	43-1150	236	MO-150	34-1258	159	MO-411	34-1174	161	PC-065	42-1073	225
LS-253	39-1665	198	LS-440	39-1541	197	MG-359-01	43-1190	236	MO-150-01	34-1259	159	MO-412	34-1175	161	PC-066	42-1074	225
LS-254	39-1666	198	LS-441	39-1542	197	MG-360	43-1151	236	MO-150-02	34-1261	159	MO-413	34-1176	161	PC-067	42-1075	225
LS-255	39-1641	198	LS-442	39-1543	197	MG-360-01	43-1191	236	MO-155	34-1191	161	MO-414	34-1177	161	PC-068	42-1076	225
LS-256	39-1642	198	LS-443	39-1544	197	MG-361	43-1152	236	MO-156	34-1192	161	MO-415	34-1181	161	PC-070	42-1061	225
LS-257	39-1643	198	LS-445	39-1548	197	MG-361-01	43-1192	236	MO-157	34-1193	161	MO-416	34-1178	161	PC-072	42-1063	225
LS-258	39-1644	198	LS-450	39-1551	197	MG-362	43-1161	236	MO-157-01	34-1262	159	MO-417	34-1172	161	PC-073	42-1064	225
LS-259	39-1645	198	LS-451	39-1552	197	MG-362-01	43-1211	236	MO-157-02	34-1263	159	MO-435	34-1145	161	PC-074	42-1065	225
LS-260	39-1646	198	LS-452	39-1553	197	MG-363	43-1162	236	MO-157-03	34-1264	159	MO-436	34-1146	161	PC-075	42-1066	225
LS-303	39-1601	198	LS-453	39-1554	197	MG-363-01	43-1212	236	MO-157-04	34-1265	159	MO-437	34-1147	161	PC-079	42-1031	224
LS-304	39-1602	198	LS-454	39-1555	197	MG-364	43-1163	236	MO-157-05	34-1266	159	MO-438	34-1148	161	PC-080	42-1032	224
LS-305	39-1603	198	LS-455	39-1556	197	MG-364-01	43-1213	236	MO-157-06	34-1267	159	MO-439	34-1151	161	PC-081	42-1033	224
LS-306	39-1604	198	LS-456	39-1561	197	MG-365	43-1164	236	MO-157-07	34-1268	159	MO-593	34-1255	159	PC-082	42-1034	224
LS-307	39-1605	198	LS-457	39-1562	197	MG-365-01	43-1214	236	MO-158	34-1131	160	MO-594	34-1256	159	PC-083	42-1035	224
LS-313	39-1621	198	LS-458	39-1563	197	MG-366	43-1165	236	MO-159	34-1132	160	MO-595	34-1257	159	PC-084	42-1036	224
LS-314	39-1622	198	LS-459	39-1564	197	MG-366-01	43-1215	236	MO-160	34-1059	160	MO-596	34-1271	159	PC-085	42-1041	224
LS-315	39-1623	198	LS-460	39-2263	197	MG-367	43-1166	236	MO-161	34-1058	160	MO-597	34-1272	159	PC-086	42-1042	224
LS-316	39-1624	198	LS-461	39-2264	197	MG-367-01	43-1216	236	MO-162	34-1064	160	MO-598	34-1254	159	PC-091	42-1021	224
LS-317	39-1625	198	LW-110	39-2051	321	MG-368	43-1167	236	MO-163	34-1067	160	MO-598-01	34-1253	159	PC-092	42-1022	224
LS-323	39-1611	198	LW-115	39-2052	321	MG-368-01	43-1217	236	MO-165	34-1068	160	MS-101	34-1281	159	PC-092-01	42-1023	224
LS-324	39-1612	198	LW-120	39-2053	321	MG-369	43-1168	236	MO-166	34-1161	160	PA-001	53-1366	292	PC-093	42-1015	224
LS-325	39-1613	198	LW-125	39-2054	321	MG-369-01	43-1218	236	MO-167	34-1162	160	PA-002	53-1365	292	PC-093-01	42-1014	224
LS-326	39-1614	198	LW-130	39-2055	321	MG-370	43-1169	236	MO-170	34-1141	161	PA-021	53-1341	292	PC-676	45-1191	226
LS-327	39-1615	198	LW-135	39-2056	321	MG-370-01	43-1219	236	MO-171	34-1142	161	PA-022	53-1351	292	PC-677	45-1192	226
LS-329	39-1631	198	LW-140	39-2057	321	MG-371	43-1170	236	MO-172	34-1055	160	PA-023	53-1342	292	PC-678	45-1193	226
LS-330	39-1632	198	LW-145	39-2058	321	MG-371-01	43-1220	236	MO-173	34-1056	160	PA-024	53-1352	292	PC-679	45-1194	226
LS-331	39-1633	198	LW-204	39-2061	321	MG-372	43-1171	236	MO-177	34-1061	160	PA-025	53-1343	292	PC-680	45-1076	244
LS-332	39-1634	198	LW-205	39-2062	321	MG-372-01	43-1221	236	MO-200	34-1269	159	PA-026	53-1353	292	PC-681	45-1077	244
LS-333	39-1635	198	LW-207	39-2063	321	MG-373	43-1172	236	MO-255	34-1361	159	PA-027	53-1344	292	PC-685	45-1071	244
LS-334	39-1636	198	LW-210	39-2064	321	MG-373-01	43-1222	236	MO-256	34-1363	159	PA-028	53-1354	292	PC-687	45-1072	244
LS-390	45-1018	244	LW-212	39-2068	321	MG-375	43-1231	234	MO-257	34-1364	159	PB-210	50-1131	271	PC-699	45-1041	227
LS-391	45-1015	244	MA-100	42-1391	56	MG-401	23-1231	46	MO-258	34-1365	159	PB-211	50-1132	271	PC-700	45-1061	244
LS-392	45-1031	244	MA-102	42-1392	56	MG-402	23-1232	46	MO-259	34-1368	159	PB-214	50-1136	271	PC-701	45-1062	244
LS-393	45-1016	244	MA-103	42-1393	56	MG-403	23-1233	46	MO-270	34-1341	162	PB-217	50-1137	271	PC-702	45-1066	244
LS-395	39-1452	196	MD-015	35-1106	169	MG-404	23-1234	46	MO-270-01	34-1342	162	PC-005	42-1171	227	PC-703	45-1067	244
LS-396	39-1453	196	MD-020	35-1107	169	MG-405	23-1235	46	MO-270-02	34-1343	162	PC-011	42-1091	225	PC-703-01	45-1068	244
LS-397	39-1454	196	MD-021	35-1108	169	MG-406	23-1236	46	MO-270-03	34-1347	162	PC-012	42-1092	225	PC-704	45-1051	227
LS-398	39-1455	196	MD-022	35-1109	169	MG-407	23-1237	46	MO-272	34-1344	162	PC-013	42-1093	225	PC-705	45-1052	227
LS-398-01	39-1465	196	MD-025	35-1189	129	MG-408	23-1238	46	MO-272-01	34-1345	162	PC-015	42-1097	225	PC-706	45-1053	227
LS-399	39-1464	196	MD-030	35-1188	129	MG-409	23-1239	46	MO-272-02	34-1346	162	PC-016	42-1098	225	PC-707	45-1054	227
LS-400	39-1451	196	MD-031	35-1185	129	MG-410	23-1240	46	MO-300	34-1331	162	PC-017	42-1099	225	PC-708	45-1055	227
LS-400-01	39-1461	196	MD-031-01	35-1186	129	MG-411	23-1241	46	MO-300-01	34-1330	162	PC-020	42-1105	225	PC-710	42-1169	226
LS-401	45-1024	244	MG-345	43-1131	236	MG-412	23-1242	46	MO-301	34-1332	162	PC-024	42-1110	225	PC-711	42-1164	226
LS-401-01	45-1025	244	MG-346	43-1132	236	MG-413	23-1243	46	MO-301-01	34-1333	162	PC-029	42-1107	225	PC-715	42-1141	226
LS-401-03	45-1021	244	MG-347	43-1133	236	MG-414	23-1244	46	MO-301-02	34-1337	162	PC-030	42-1108	225	PC-720	42-1142	226
LS-401-04	45-1022	244	MG-348	43-1134	236	MG-415	23-1245	46	MO-301-03	34-1338	162	PC-035	42-1082	225	PC-724	42-1143	226
LS-401-05	45-1023	244	MG-350	43-1141	236	MG-426	23-1251	46	MO-301-04	34-1335	162	PC-037	42-1081	225	PC-725	42-1144	226
LS-402	39-1501	197	MG-350-01	43-1181	236	MG-427	23-1255	46	MO-301-05	34-1339	162	PC-038	42-1118	225	PC-730	42-1145	226
LS-403	39-1502	197	MG-351	43-1142	236	MG-428	23-1252	46	MO-302	34-1334	162	PC-040	42-1084	225	PC-735	42-1146	226
LS-404	39-1503	197	MG-351-01	43-1182	236	MO-071	34-1011	158	MO-303	34-1336	162	PC-044	42-1083	225	PC-738	42-1161	226
LS-405	39-1504	197	MG-352	43-1143	236	MO-072	34-1012	158	MO-310	34-1101	158	PC-045	42-1114	225	PC-740	42-1151	226
LS-407	39-1505	197	MG-352-01	43-1183	236	MO-076	34-1016	158	MO-311	34-1102	158	PC-050	42-1051	224	PC-741	42-1152	226
LS-410	39-1506	197	MG-353	43-1144	236	MO-077	34-1017	158	MO-330	34-1211	161	PC-051	42-1052	224	PC-742	42-1153	226
LS-411	39-2261	197	MG-353-01	43-1184	236	MO-082	34-1021	158	MO-331	34-1214	161	PC-052	42-1053	224	PC-743	42-1154	226
LS-412	39-2262	197	MG-354	43-1145	236	MO-083	34-1022	158	MO-332	34-1212	161	PC-053	42-1054	224	PC-744	42-1155	226

OLD # TO NEW



OLD #	NEW #	PG#	OLD #	NEW #	PG#	OLD #	NEW #	PG#	OLD #	NEW #	PG#	OLD #	NEW #	PG#	OLD #	NEW #	PG#
PC-754	42-1166	226	PE-505	40-1030	202	PJ-043	41-1206	217	PJ-708	41-1138	214	PJ-941	41-1351	220	PL-214-WM	64-214WM	207
PC-755	42-1167	226	PE-506	40-1031	202	PJ-045	41-1212	217	PJ-710	41-1151	215	PJ-942	41-1355	220	PL-215-GM	64-215GM	207
PC-756	28-1362	107	PE-507	40-1032	202	PJ-046	41-1213	217	PJ-711	41-1152	215	PJ-943	41-1356	220	PL-215-WM	64-215WM	207
PC-757	28-1368	106	PE-508	40-1033	202	PJ-047	41-1214	217	PJ-712	41-1153	215	PJ-944	41-1357	220	PL-216-GM	64-216GM	207
PC-758	28-1351	107	PE-508-01	40-1035	202	PJ-048	41-1215	217	PJ-713	41-1155	215	PJ-945	41-1511	235	PL-216-WM	64-216WM	207
PC-759	28-1352	107	PE-509	40-1034	202	PJ-049	41-1216	217	PJ-714	41-1154	215	PJ-946	41-1512	220	PL-217-GM	64-217GM	207
PC-760	28-1353	107	PE-509-01	40-1040	202	PJ-051	41-1121	213	PJ-715	41-1157	215	PJ-947	41-1513	220	PL-217-WM	64-217WM	207
PC-762	28-1356	107	PE-509-02	40-1042	202	PJ-052	41-1122	213	PJ-716	41-1158	215	PJ-948	41-1514	220	PL-301-G	64-301G	207
PC-763	28-1366	106	PE-509-03	40-1041	202	PJ-053	41-1123	213	PJ-717	41-1185	216	PJ-949	41-1515	220	PL-301-W	64-301W	207
PC-764	28-1367	106	PE-509-04	40-1036	202	PJ-054	41-1124	213	PJ-718	41-1159	215	PJ-950	41-1516	220	PL-302-G	64-302G	207
PC-765	28-1357	107	PE-509-05	40-1037	202	PJ-055	41-1125	213	PJ-722	41-1156	215	PL-001-G	64-001G	207	PL-302-W	64-302W	207
PC-766	28-1358	107	PE-509-06	40-1038	202	PJ-056	41-1126	213	PJ-723	41-1186	216	PL-001-W	64-001W	207	PL-303-G	64-303G	207
PC-767	28-1361	107	PE-511	40-1051	202	PJ-057	41-1127	213	PJ-725	41-2184	221	PL-002-G	64-002G	207	PL-303-W	64-303W	207
PC-768	28-1359	107	PE-511-01	40-1052	202	PJ-058	41-1128	213	PJ-727	41-1331	220	PL-002-W	64-002W	207	PL-304-G	64-304G	207
PC-770	28-1363	107	PE-512	40-1015	203	PJ-059	41-1129	213	PJ-728	41-1332	220	PL-003-G	64-003G	207	PL-304-W	64-304W	207
PC-771	28-1364	107	PE-513	40-1197	202	PJ-100	41-1017	210	PJ-729	41-1333	220	PL-003-W	64-003W	207	PL-305-G	64-305G	207
PC-772	28-1365	107	PE-514	36-1053	174	PJ-102	41-1018	210	PJ-730	41-1334	220	PL-004-G	64-004G	207	PL-305-W	64-305W	207
PC-800	45-1095	227	PE-515	40-1045	202	PJ-104	41-1016	210	PJ-731	41-1311	219	PL-004-W	64-004W	207	PL-306-G	64-306G	207
PC-801	45-1096	227	PE-516	40-1044	202	PJ-106	41-1012	210	PJ-732	41-1312	219	PL-005-G	64-005G	207	PL-306-W	64-306W	207
PE-050	28-1231	104	PE-517	40-1046	202	PJ-108	41-1011	210	PJ-733	41-1225	218	PL-005-W	64-005W	207	PL-307-G	64-307G	207
PE-056	28-1233	104	PE-517-01	40-1055	202	PJ-110	41-1019	210	PJ-734	41-1226	218	PL-006-G	64-006G	207	PL-307-W	64-307W	207
PE-100	40-1171	205	PE-517-02	40-1047	202	PJ-140	41-1040	211	PJ-735	41-1227	218	PL-006-W	64-006W	207	PL-308-G	64-308G	207
PE-101	40-1172	205	PE-517-03	40-1056	202	PJ-141	41-1041	211	PJ-736	41-1245	218	PL-007-G	64-007G	207	PL-308-W	64-308W	207
PE-102	40-1173	205	PE-517-10	40-1161	205	PJ-142	41-1042	211	PJ-737	41-1241	218	PL-007-W	64-007W	207	PL-309-G	64-609G	207
PE-103	40-1174	205	PE-518	40-1162	205	PJ-145	41-1045	211	PJ-738	41-1234	235	PL-008-G	64-008G	207	PL-309-W	64-309W	207
PE-104	40-1175	205	PE-519	40-1163	205	PJ-150	41-1050	211	PJ-739	41-1224	235	PL-008-W	64-008W	207	PL-310-G	64-310G	207
PE-105	40-1176	205	PE-522	40-1167	205	PJ-151	41-1051	211	PJ-740	41-1243	218	PL-009-G	64-009G	207	PL-310-W	64-310W	207
PE-106	40-1177	205	PE-523	40-1168	205	PJ-155	41-1055	211	PJ-741	41-1244	218	PL-009-W	64-009W	207	PL-311-G	64-311G	207
PE-107	40-1178	205	PE-523-01	40-1165	205	PJ-160	41-1060	211	PJ-742	41-1236	218	PL-010-G	64-010G	207	PL-311-W	64-311W	207
PE-108	40-1183	205	PE-523-02	40-1166	205	PJ-189	41-1071	211	PJ-800	41-1091	212	PL-010-W	64-010W	207	PL-312-G	64-312G	207
PE-114	40-1151	205	PE-524	40-1213	200	PJ-190	41-1072	211	PJ-801	41-1092	212	PL-011-G	64-011G	207	PL-312-W	64-312W	207
PE-118	40-1152	205	PE-524-01	40-1212	200	PJ-191	41-1076	211	PJ-802	41-1095	212	PL-011-W	64-011W	207	PL-313-G	64-313G	207
PE-120	40-1157	205	PE-524-02	40-1214	200	PJ-193	41-1073	211	PJ-803	41-1093	212	PL-012-G	64-012G	207	PL-313-W	64-313W	207
PE-121	40-1158	205	PE-524-03	40-1222	200	PJ-195	41-1074	211	PJ-804	41-1096	212	PL-012-W	64-012W	207	PL-401-G	64-401G	207
PE-122	40-1154	205	PE-524-04	40-1216	200	PJ-198	41-1075	211	PJ-825	41-1192	216	PL-013-G	64-013G	207	PL-401-W	64-401W	207
PE-122-01	40-1159	203	PE-524-05	40-1217	200	PJ-200	41-1082	212	PJ-826	41-1191	216	PL-013-W	64-013W	207	PL-402-G	64-402G	207
PE-123-01	40-1021	203	PE-524-06	40-1215	200	PJ-201	41-1081	212	PJ-827	41-1193	216	PL-014-G	64-014G	207	PL-402-W	64-402W	207
PE-127	40-1012	203	PE-524-08	40-1221	200	PJ-202	41-1085	212	PJ-829	41-1194	216	PL-201-GM	64-201GM	207	PL-403-G	64-403G	207
PE-127-01	40-1017	203	PE-524-10	40-1231	201	PJ-203	41-1084	212	PJ-835	41-1221	218	PL-201-WM	64-201WM	207	PL-403-W	64-403W	207
PE-127-02	40-1013	203	PE-524-11	40-1232	201	PJ-204	41-1083	212	PJ-836	41-1222	235	PL-202-GM	64-202GM	207	PL-404-G	64-404G	207
PE-128	40-1014	203	PE-524-12	40-1233	201	PJ-301	41-1111	212	PJ-836-01	41-1223	235	PL-202-WM	64-202WM	207	PL-404-W	64-404W	207
PE-129	40-1091	204	PE-524-13	40-1234	201	PJ-302	41-1112	212	PJ-837	41-1181	216	PL-203-GM	64-203GM	207	PL-405-G	64-405G	207
PE-130	40-1092	204	PE-524-14	40-1235	201	PJ-303	41-1113	212	PJ-838	41-1183	216	PL-203-WM	64-203WM	207	PL-405-W	64-405W	207
PE-131	40-1093	204	PE-525	40-1095	204	PJ-304	41-1114	212	PJ-839	41-1182	216	PL-204-GM	64-204GM	207	PL-501-G	64-501G	207
PE-135	40-1061	204	PE-525-01	40-1096	204	PJ-310	41-1161	215	PJ-840	41-1184	216	PL-204-WM	64-204WM	207	PL-501-W	64-501W	207
PE-136	40-1066	204	PE-526	40-1191	205	PJ-311	41-1163	215	PJ-841	41-1313	219	PL-205-GM	64-205GM	207	PL-502-G	64-502G	207
PE-137	40-1067	204	PE-527	40-1101	204	PJ-312	41-1165	215	PJ-842	41-1318	219	PL-205-WM	64-205WM	207	PL-502-W	64-502W	207
PE-138	40-1063	204	PE-528	40-1102	204	PJ-313	41-1162	215	PJ-843	41-1321	219	PL-206-GM	64-206GM	207	PL-503-G	64-503G	207
PE-139	40-1064	204	PE-529	40-1103	204	PJ-314	41-1164	215	PJ-844	41-1322	219	PL-206-WM	64-206WM	207	PL-503-W	64-503W	207
PE-139-01	40-1068	204	PE-530	40-1105	204	PJ-315	41-1166	215	PJ-845	41-1323	219	PL-207-GM	64-207GM	207	PL-504-G	64-504G	207
PE-141	40-1086	204	PE-532	40-1106	204	PJ-650	41-1171	216	PJ-846	41-1317	219	PL-207-WM	64-207WM	207	PL-504-W	64-504W	207
PE-142	40-1081	204	PE-534	40-1111	204	PJ-651	41-1172	216	PJ-847	41-1319	219	PL-208-GM	64-208GM	207	PL-505-G	64-505G	207
PE-143	40-1082	204	PE-535	40-1112	204	PJ-652	41-1173	216	PJ-848	41-1314	219	PL-208-WM	64-208WM	207	PL-505-W	64-505W	207
PE-150	40-1131	206	PE-540	40-1192	205	PJ-653	41-1174	216	PJ-849	41-1315	219	PL-209-GM	64-209GM	207	PL-506-G	64-506G	207
PE-151	40-1132	206	PE-541	40-1193	205	PJ-654	41-1175	216	PJ-900	43-1094	235	PL-209-WM	64-209WM	207	PL-506-W	64-506W	207
PE-152	40-1133	206	PE-542	40-1255	201	PJ-698	41-1141	214	PJ-901	43-1095	235	PL-210-GM	65-210GM	207	PL-507-G	64-507G	207
PE-153	40-1134	206	PE-544	40-1251	201	PJ-699	41-1142	214	PJ-910	41-1341	220	PL-210-WM	64-210WM	207	PL-507-W	64-507W	207
PE-160	50-1111	271	PE-545	40-1253	201	PJ-701	41-1131	214	PJ-911	41-1342	220	PL-211-GM	64-211GM	207	PL-508-G	64-508G	207
PE-161	50-1112	271	PJ-037	41-1251	218	PJ-702	41-1132	214	PJ-912	41-1343	220	PL-211-WM	64-211WM	207	PL-508-W	64-508W	207
PE-162	50-1113	271	PJ-038	41-1252	218	PJ-703	41-1133	214	PJ-913	41-1344	220	PL-212-GM	64-212GM	207	PL-509-G	64-509G	207
PE-163	50-1114	271	PJ-039	41-1202	217	PJ-704	41-1134	214	PJ-934	41-1353	220	PL-212-WM	64-212WM	207	PL-509-W	64-509W	207
PE-164	50-1116	271	PJ-040	41-1203	217	PJ-705	41-1135	214	PJ-935	41-1354	220	PL-213-GM	64-213GM	207	PL-601-G	64-601G	207
PE-175	40-1198	206	PJ-041	41-1204	217	PJ-706	41-1136	214	PJ-936	41-1517	220	PL-213-WM	64-213WM	207	PL-601-W	64-601W	207
PE-176	40-1199	206	PJ-042	41-1205	217	PJ-707	41-1137	214	PJ-940	41-1352	220	PL-214-GM	64-214GM	207	PL-602-G	64-602G	207



OLD # TO NEW#

OLD #	NEW #	PG#	OLD #	NEW #	PG#	OLD #	NEW #	PG#	OLD #	NEW #	PG#	OLD #	NEW #	PG#	OLD #	NEW #	PG#
PL-602-W	64-602W	207	PU-012	51-1392	276	PU-198	51-1260	276	PU-414	51-1614	278	PV-416	23-1281	47	RM-058	44-1181	240
PL-603-G	64-603G	207	PU-014	51-1393	276	PU-209	51-1009	276	PU-415	51-1615	278	PV-417	23-1282	47	RM-059	44-1182	240
PL-603-W	64-603W	207	PU-015	51-1397	277	PU-210	51-1010	276	PU-418	51-1618	278	PV-418	23-1284	47	RM-089	44-1126	238
PL-604-G	64-604G	207	PU-016	51-1309	276	PU-212	51-1012	276	PU-420	51-1620	278	RD-171	30-1271	120	RM-090	44-1146	239
PL-604-W	64-604W	207	PU-017	51-1310	276	PU-214	51-1014	276	PU-421	51-1621	278	RD-172	30-1272	120	RM-091	44-1136	239
PL-605-G	64-605G	207	PU-018	51-1312	276	PU-218	51-1018	276	PU-422	51-1622	278	RD-173	30-1273	120	RM-092	44-1137	239
PL-605-W	64-605W	207	PU-019	51-1314	276	PU-220	51-1015	276	PU-424	51-1624	278	RD-174	30-1274	120	RM-093	44-1138	239
PL-701-G	64-701G	207	PU-019-01	51-1315	276	PU-221	51-1021	276	PU-425	51-1154	278	RG-001	43-1111	235	RM-099	44-1141	239
PL-701-W	64-701W	207	PU-020	51-1318	276	PU-222	51-1022	276	PU-426	51-1155	278	RG-002	43-1112	235	RM-103	44-1142	239
PL-702-G	64-702G	207	PU-021	51-1321	276	PU-224	51-1024	276	PU-426-01	51-1156	278	RG-003	43-1113	235	RM-104	44-1112	238
PL-702-W	64-702W	207	PU-022	51-1322	276	PU-225	51-1059	276	PU-427	51-1158	278	RG-004	43-1114	235	RM-105	44-1122	238
PL-800	64-8000	207	PU-023	51-1324	276	PU-228	51-1025	276	PU-428	51-1131	278	RG-005	43-1121	235	RM-106	44-1113	238
PL-821-GM	64-821GM	207	PU-024	51-1331	276	PU-229	51-1031	276	PU-429	51-1151	278	RG-006	43-1122	235	RM-107	44-1123	238
PL-821-WM	64-821WM	207	PU-025	51-1326	276	PU-230	51-1026	276	PU-430	51-1633	278	RG-007	43-1123	235	RM-108	44-1114	238
PL-822-GM	64-822GM	207	PU-026	51-1341	276	PU-240	51-1041	276	PU-440	51-1641	278	RG-008	43-1124	235	RM-109	44-1124	238
PL-822-WM	64-822WM	207	PU-028	51-1325	276	PU-249	51-1032	276	PU-448	51-1651	278	RI-101	23-1045	41	RM-110	44-1133	238
PL-823-GM	64-823GM	207	PU-029	51-1358	276	PU-250	51-1042	276	PU-449	51-1652	278	RI-102	23-1046	41	RM-111	44-1134	238
PL-823-WM	64-823WM	207	PU-030	51-1351	276	PU-251	51-1061	276	PU-450	51-1642	278	RI-103	23-1047	41	RM-113-01	44-1151	241
PL-824-GM	64-824GM	207	PU-031	51-1332	276	PU-252	51-1062	276	PU-451	51-1661	278	RI-104	23-1052	41	RM-114-01	44-1152	241
PL-824-WM	64-824WM	207	PU-031-01	51-1333	276	PU-253	51-1063	276	PU-455	51-1664	278	RI-105	23-1048	41	RM-115	44-1154	241
PL-825-GM	64-825GM	207	PU-032	51-1342	276	PU-254	51-1064	276	PU-458	51-1662	278	RI-106	23-1041	41	RM-116-01	44-1153	241
PL-825-WM	64-825WM	207	PU-033	51-1352	276	PU-255	51-1065	276	PU-475	51-1663	278	RI-107	23-1042	41	RM-118	44-1156	241
PL-826-GM	64-826GM	207	PU-034	51-1353	276	PU-256	51-1060	276	PU-491	51-1665	278	RI-108	23-1051	41	RM-120	44-1132	238
PL-826-WM	64-826WM	207	PU-035	51-1357	276	PU-257	51-1033	276	PU-491-01	51-1666	278	RI-109	43-1091	235	RM-139	44-1192	241
PL-827-GM	64-827GM	207	PU-035-01	51-1354	276	PU-261	51-1159	276	PU-492	51-1667	278	RI-112	43-1036	232	RM-140	44-1191	241
PL-827-WM	64-827WM	207	PU-035-02	51-1355	276	PU-262	51-1161	276	PU-495	51-1668	278	RI-113	43-1037	232	RM-141	44-1195	241
PL-828-GM	64-828GM	207	PU-035-03	51-1356	276	PU-263	51-1162	276	PU-496	51-1669	278	RI-113-01	43-1038	232	SA-001	45-1011	244
PL-828-WM	64-828WM	207	PU-035-04	51-1363	276	PU-264	51-1163	276	PU-497	51-1670	278	RI-114	43-1071	233	SA-002	45-1012	244
PL-829-GM	64-829GM	207	PU-035-05	51-1359	276	PU-265	51-1164	276	PU-498	51-1671	278	RI-115	38-1351	188	SA-004	45-1093	244
PL-829-WM	64-829WM	207	PU-035-06	51-1361	276	PU-266	51-1165	276	PU-499	51-1631	278	RI-115-01	38-1352	188	SA-004-01	45-1094	244
PL-830-GM	64-830GM	207	PU-035-07	51-1362	276	PU-267	51-1160	276	PU-500	51-1632	278	RI-115-02	38-1353	188	SA-011	45-1081	206
PL-830-WM	64-830GM	207	PU-035-08	51-1365	276	PU-275	51-1386	276	PU-501	51-1672	278	RI-115-03	38-1354	188	SA-012	45-1082	206
PL-831-GM	64-831-GM	207	PU-035-09	51-1360	276	PU-276	51-1387	276	PU-502	51-1673	278	RI-117	43-1061	233	SA-013	45-1083	206
PL-831-WM	64-831WM	207	PU-035-10	51-1364	276	PU-286	51-1388	276	PU-509	51-1381	276	RI-119	43-1056	233	SB-001	46-1331	248
PL-832-GM	64-832GM	207	PU-109	51-1209	276	PU-287	51-1389	276	PU-510	51-1382	276	RI-120	43-1057	233	SB-002	46-1332	248
PL-832-WM	64-832WM	207	PU-110	51-1210	276	PU-317	51-1051	276	PU-524	51-1581	277	RI-125	43-1011	232	SB-002-01	46-1333	248
PL-841-GM	64-841G	207	PU-112	51-1212	276	PU-358	51-1052	276	PU-525	51-1582	277	RI-126	43-1012	232	SB-010	46-1311	248
PL-841-WM	64-841W	207	PU-114	51-1214	276	PU-375	51-1053	276	PU-526	51-1583	277	RI-127	43-1031	232	SB-011	46-1312	248
PL-842-GM	64-842G	207	PU-115	51-1215	276	PU-387	51-1054	276	PU-527	51-1383	276	RI-128	43-1032	232	SB-100	46-1127	247
PL-842-WM	64-842W	207	PU-118	51-1218	276	PU-390	51-1058	276	PU-528	51-1577	277	RI-129	43-1022	232	SB-101	46-1128	247
PL-843-GM	64-843G	207	PU-121	51-1221	276	PU-391	51-1055	276	PU-529	51-1578	277	RI-130	43-1021	232	SB-102	46-1129	247
PL-843-WM	64-843W	207	PU-122	51-1222	276	PU-392	51-1057	276	PU-530	51-1384	276	RI-131	43-1023	232	SB-103	46-1130	247
PL-844-GM	64-844G	207	PU-124	51-1224	276	PU-393	51-1056	276	PU-531	51-1571	277	RI-132	43-1024	232	SB-104	46-1131	247
PL-844-WM	64-844W	207	PU-128	51-1225	276	PU-393-01	51-1109	276	PU-532	51-1572	277	RI-134	43-1064	233	SB-105	46-1132	247
PL-845-GM	64-845G	207	PU-129	51-1231	276	PU-394	51-1112	276	PU-533	51-1573	277	RI-135	43-1041	232	SB-120	46-1126	247
PL-845-WM	64-845W	207	PU-130	51-1226	276	PU-395	51-1110	276	PU-534	51-1574	277	RI-138	43-1045	232	SB-130	46-1125	247
PL-846-GM	64-846G	207	PU-140	51-1241	276	PU-396	51-1114	276	PV-400	23-1141	43	RI-139	43-1042	232	SB-140	46-1124	247
PL-846-WM	64-846W	207	PU-141	51-1251	276	PU-396-01	51-1115	276	PV-400-01	23-1142	43	RI-149	23-1271	233	SB-150	46-1123	247
PL-847-GM	64-847G	207	PU-149	51-1232	276	PU-397	51-1118	276	PV-401	57-1061	314	RI-150	23-1272	233	SB-160	46-1122	247
PL-847-WM	64-847W	207	PU-150	51-1242	276	PU-398	51-1132	276	PV-401-01	57-1062	314	RI-160	23-1053	41	SB-160-01	46-1121	247
PL-848-GM	64-848G	207	PU-151	51-1233	276	PU-398-01	51-1133	276	PV-402	57-1011	35	RI-165	23-1055	42	SB-160-03	46-1148	247
PL-848-WM	64-848W	207	PU-158	51-1252	276	PU-399	51-1121	276	PV-403	57-1012	314	RI-166	49-1028	262	SB-161	46-1149	247
PL-849-GM	64-849W	207	PU-175	51-1253	276	PU-400	51-1122	276	PV-404	57-1013	314	RI-170	43-1051	233	SB-162	46-1150	247
PL-849-WM	64-849G	207	PU-187	51-1254	276	PU-401	51-1124	276	PV-405	57-1041	35	RM-001	44-1011	241	SB-163	46-1151	247
PL-850-GM	64-850W	207	PU-191	51-1255	276	PU-402	51-1126	276	PV-406	57-1031	314	RM-002	44-1012	241	SB-164	46-1152	247
PL-850-WM	64-850G	207	PU-191-01	51-1256	276	PU-403	51-1141	276	PV-407	57-1051	314	RM-003	44-1013	241	SB-165	46-1153	247
PL-851-GM	64-851G	207	PU-192	51-1257	276	PU-404	51-1142	276	PV-408	57-1052	314	RM-050	44-1161	240	SB-220	46-1147	247
PL-851-WM	64-851W	207	PU-193	51-1258	276	PU-405	51-1152	276	PV-409	44-1028	314	RM-051	44-1162	240	SB-230	46-1146	247
PL-852-GM	64-852G	207	PU-194	51-1259	276	PU-406	51-1153	276	PV-410	57-1021	314	RM-052	44-1166	240	SB-240	46-1145	247
PL-852-WM	64-852W	207	PU-195	51-1261	276	PU-407	51-1157	276	PV-411	57-1022	314	RM-053	44-1167	240	SB-250	46-1144	247
PL-853-GM	64-853G	207	PU-196	51-1262	276	PU-408	51-1125	276	PV-412	57-1023	314	RM-054	44-1171	240	SB-251	46-1143	247
PU-001	51-1675	278	PU-196-01	51-1263	276	PU-409	51-1609	278	PV-413	57-1024	314	RM-055	44-1172	240	SB-252	46-1142	247
PU-001-01	51-1677	278	PU-196-02	51-1264	276	PU-410	51-1610	278	PV-414	57-1025	314	RM-056	44-1176	240	SB-253	46-1141	247
PU-010	51-1391	276	PU-197	51-1265	276	PU-412	51-1612	278	PV-415	57-1071	314	RM-057	44-1177	240	SB-260	46-1168	247

OLD # TO NEW



OLD #	NEW #	PG#	OLD #	NEW #	PG#	OLD #	NEW #	PG#	OLD #	NEW #	PG#	OLD #	NEW #	PG#	OLD #	NEW #	PG#
SB-261	46-1169	247	SC-018	47-1241	254	SC-473	47-1021	251	SF-763	46-1042	246	SO-116	50-1092	270	ST-096-01	55-1239	306
SB-262	46-1170	247	SC-019	47-1221	254	SC-474	47-1034	251	SF-764	46-1043	246	SO-117	50-1093	270	ST-097	55-1241	306
SB-263	46-1171	247	SC-019-01	47-1222	254	SC-484	47-1015	251	SF-765	46-1044	246	SO-118	50-1101	271	ST-098	55-1242	306
SB-264	46-1172	247	SC-019-02	47-1223	254	SC-485	47-1011	251	SF-766	46-1045	246	SO-119	50-1188	272	ST-099	55-1243	306
SB-265	46-1173	247	SC-019-03	47-1281	255	SC-488	47-1031	251	SF-767	46-1046	246	SO-119-01	50-1189	272	ST-100	55-1031	299
SB-320	46-1167	247	SC-019-04	47-1282	255	SD-006	48-1081	258	SF-780	46-1056	246	SO-120	50-1187	272	ST-101	55-1032	299
SB-330	46-1166	247	SC-019-05	47-1283	255	SD-007	48-1071	258	SF-783	46-1031	246	SO-121	50-1121	271	ST-103	55-1291	305
SB-340	46-1165	247	SC-019-06	47-1284	255	SD-008	48-1082	258	SF-784	46-1032	246	SO-122	50-1161	272	ST-105	55-1011	298
SB-350	46-1164	247	SC-051	47-1150	253	SD-009	48-1072	258	SF-785	46-1033	246	SO-123	50-1181	272	ST-107	55-1013	298
SB-360	46-1163	247	SC-054-01	47-1151	252	SD-010	48-1085	258	SF-788	46-1011	246	SO-124	50-1182	272	ST-108	55-1015	298
SB-361	46-1162	247	SC-054-02	47-1153	252	SD-011	48-1011	258	SH-700	41-2161	221	SO-125	50-1183	272	ST-109	55-1017	298
SB-362	46-1161	247	SC-055	47-1154	252	SD-014	48-1012	258	SH-701	41-2162	221	SO-126	50-1162	272	ST-110	55-1021	298
SB-400	46-1256	247	SC-055-01	47-1161	252	SD-015	48-1013	258	SH-702	41-2163	221	SO-127	50-1163	272	ST-111	55-1022	298
SB-401	46-1257	247	SC-055-02	47-1163	252	SD-016	48-1014	258	SH-703	41-2164	221	SO-128	50-1141	271	ST-112	55-1023	298
SB-402	46-1258	247	SC-055-03	47-1165	252	SD-017	48-1015	258	SH-704	41-2181	221	SO-129	50-1142	271	ST-113	55-1024	298
SB-403	46-1259	247	SC-057	47-1155	252	SD-018	48-1016	258	SH-705	41-2191	222	SO-129-01	50-1143	271	ST-115	55-1111	300
SB-404	46-1260	247	SC-057-01	47-1156	252	SD-019	48-1017	258	SH-705-01	41-2192	222	SO-130	50-2024	273	ST-116	55-1114	300
SB-405	46-1261	247	SC-057-02	47-1157	252	SD-020	48-1018	258	SH-708	41-2173	221	SO-131	50-2027	273	ST-117	55-1112	300
SB-420	46-1255	247	SC-059	47-1159	252	SD-021	48-1019	258	SH-709	41-2174	221	SO-132	50-2028	273	ST-118	55-1113	300
SB-430	46-1254	247	SC-070	47-1172	253	SD-022	48-1020	258	SH-712-01	41-2212	235	SO-135	50-2029	273	ST-120	55-1121	300
SB-440	46-1253	247	SC-071	47-1171	253	SD-023	48-1021	258	SH-713	41-2214	235	SO-136	50-2031	273	ST-121	55-1122	300
SB-450	46-1252	247	SC-072	47-1174	253	SD-060	48-1032	258	SH-714	41-2221	235	SO-201	50-1521	274	ST-122	55-1123	300
SB-460	46-1251	247	SC-073	47-1173	253	SD-080	48-1033	258	SH-714-01	41-2224	235	SO-202	50-1522	274	ST-123	55-1124	300
SB-500	46-1188	247	SC-073-01	47-1175	253	SD-100	48-1034	258	SH-715	41-2222	235	SO-350	50-1191	273	ST-130	55-1131	300
SB-501	46-1189	247	SC-073-02	47-1176	253	SD-120	48-1035	258	SH-715-01	41-2225	235	SO-350-01	50-1192	273	ST-131	55-1132	300
SB-502	46-1190	247	SC-080	47-1181	253	SD-140	48-1036	258	SH-721	41-1412	235	SO-352	50-1184	272	ST-134	55-1165	301
SB-503	46-1191	247	SC-081	47-1182	253	SD-160	48-1037	258	SH-722	41-1414	235	SO-353	50-1185	272	ST-135	55-1161	301
SB-504	46-1192	247	SC-082	47-1183	253	SD-200	48-1039	258	SH-722	41-2194	222	SO-354	50-1186	272	ST-136	55-1162	301
SB-505	46-1193	247	SC-083	47-1184	253	SD-250	48-1040	258	SH-722-01	41-1415	235	SO-356	50-1194	272	ST-137	55-1135	300
SB-520	46-1187	247	SC-084	47-1185	253	SD-300	48-1041	258	SH-722-02	41-1416	235	SO-358	50-1170	272	ST-137-01	55-1136	300
SB-530	46-1186	247	SC-091	47-1191	252	SD-302	48-1051	258	SH-722-03	41-1417	235	SO-358-01	50-1171	272	ST-137-02	55-1137	300
SB-540	46-1185	247	SC-092	47-1192	252	SD-303	48-1052	258	SH-722-04	41-1418	235	SO-358-02	50-1172	272	ST-137-03	55-1138	300
SB-550	46-1184	247	SC-093	47-1193	252	SD-304	48-1053	258	SH-722-05	41-1419	235	SO-360	50-1173	272	ST-137-04	55-1139	300
SB-560	46-1183	247	SC-094	47-1194	252	SD-305	48-1054	258	SH-723	41-2196	222	SO-361	50-1174	272	ST-142	55-1019	298
SB-570	46-1182	247	SC-095	47-1195	252	SD-306	48-1055	258	SH-725	41-2198	222	SO-362	50-1154	271	ST-145	55-1171	201
SB-580	46-1181	247	SC-096	47-1196	252	SD-307	48-1056	258	SH-726	41-2186	221	SO-363	50-1155	271	ST-146	55-1172	301
SB-600	46-1208	247	SC-166	47-1366	250	SD-308	48-1057	258	SH-730	23-1291	47	SO-364	40-1121	206	ST-202	55-1042	299
SB-601	46-1209	247	SC-167	47-1367	250	SD-309	48-1058	258	SH-731	23-1292	47	SO-365	40-1122	206	ST-203	55-1043	299
SB-602	46-1210	247	SC-172	47-1372	250	SD-310	48-1061	258	SH-735	41-2201	222	SO-366	40-1123	206	ST-204	55-1044	299
SB-603	46-1211	247	SC-173	47-1373	250	SD-311	48-1062	258	SH-736	41-2203	222	SO-367	40-1124	206	ST-205	55-1045	299
SB-604	46-1212	247	SC-175	47-1375	250	SD-312	48-1063	258	SH-737	41-2205	222	SO-368	40-1125	206	ST-206	55-1046	299
SB-605	46-1213	247	SC-176	47-1376	250	SD-313	48-1064	258	SH-738	41-2202	222	SO-369	40-1126	206	ST-207	55-1047	299
SB-620	46-1207	247	SC-181	47-1381	250	SD-314	48-1065	258	SH-739	41-2204	222	SO-370	40-1127	206	ST-217	55-1054	299
SB-630	46-1206	247	SC-182	47-1392	250	SD-315	48-1066	258	SH-742	23-1296	47	SO-371	40-1128	206	ST-223	55-1063	299
SB-640	46-1205	247	SC-210	47-1311	256	SD-316	48-1067	258	SH-743	23-1297	47	SO-372	40-1129	206	ST-224	55-1064	299
SB-650	46-1204	247	SC-241	47-1321	256	SD-317	48-1068	258	SO-099	50-1062	270	SP-071	23-1161	44	ST-225	55-1065	299
SB-660	46-1203	247	SC-242	47-1322	256	SD-318	48-1086	258	SO-100	50-1061	270	SP-072	23-1162	44	ST-226	55-1066	299
SB-670	46-1202	247	SC-243	47-1323	256	SD-321	48-1088	258	SO-101	50-1198	273	SP-074	23-1163	44	ST-231	55-1071	299
SB-680	46-1201	247	SC-244	47-1331	256	SF-101	46-1014	246	SO-101-01	50-2021	273	SP-080	23-1166	44	ST-246	55-1081	300
SB-800	46-1288	248	SC-245	47-1332	256	SF-201	46-1015	246	SO-102	50-1196	273	SP-360	50-1011	268	ST-247	55-1082	300
SB-801	46-1289	248	SC-246	47-1333	256	SF-600	46-1021	246	SO-103	50-1195	273	SP-361	50-1012	268	ST-257-01	55-1176	301
SB-802	46-1290	248	SC-247	47-1341	256	SF-601	46-1022	246	SO-104	50-1071	270	ST-087	55-1262	305	ST-258-01	55-1178	301
SB-803	46-1291	248	SC-248	47-1342	256	SF-625	46-1081	246	SO-105	50-1072	270	ST-089	55-1281	304	ST-259	55-1274	303
SB-820	46-1287	248	SC-249	47-1343	256	SF-630	46-1082	246	SO-107	50-1074	270	ST-090	55-1282	304	ST-261	55-1184	302
SB-830	46-1286	248	SC-256	47-1248	256	SF-640	46-1083	246	SO-108	50-1075	270	ST-091	55-1287	304	ST-263	55-1145	303
SC-010	47-1211	254	SC-425	47-1036	251	SF-650	46-1084	246	SO-109	50-1122	270	ST-092	55-1261	305	ST-264	55-1146	303
SC-011	47-1261	255	SC-430	47-1024	251	SF-660	46-1085	246	SO-110	50-1117	270	ST-093	55-1283	304	ST-265	55-1147	303
SC-012	47-1271	255	SC-431	47-1025	251	SF-725	46-1051	246	SO-111	50-1081	270	ST-094	55-1288	304	ST-266	55-1141	300
SC-013	47-1272	255	SC-432	47-1028	251	SF-730	46-1052	246	SO-112	50-1082	270	ST-095	55-1231	306	ST-267	55-1142	300
SC-013-01	47-1231	254	SC-433	47-1026	251	SF-740	46-1053	246	SO-113	50-1083	270	ST-095-01	55-1233	306	ST-302	55-1221	304
SC-015	47-1232	254	SC-434	47-1029	251	SF-750	46-1054	246	SO-114	50-1087	270	ST-095-02	55-1234	306	ST-303	55-1222	304
SC-017	47-1251	255	SC-440	47-1038	251	SF-760	46-1055	246	SO-114-01	50-1086	270	ST-095-03	55-1235	306	ST-304	55-1223	304
SC-017-01	47-1252	255	SC-442	47-1042	251	SF-761	46-1059	246	SO-114-05	50-1088	270	ST-095-04	55-1238	306	ST-305	55-1224	304
SC-017-02	47-1253	255	SC-443	47-1041	251	SF-762	46-1041	246	SO-115	50-1091	270	ST-096-01	55-1232	306	ST-306	55-1225	304



OLD # TO NEW#

OLD #	NEW #	PG#	OLD #	NEW #	PG#	OLD #	NEW #	PG#	OLD #	NEW #	PG#	OLD #	NEW #	PG#	OLD #	NEW #	PG#
ST-399	55-1181	302	TA-071	53-1267	291	TA-615	53-1252	291	TB-053	52-1241	285	TB-311	52-1431	288	TS-022	54-1064	294
ST-400	55-1182	302	TA-072	53-1269	291	TA-625	53-1254	291	TB-054	52-1242	285	TB-313	52-1433	288	TS-024	54-1067	294
ST-401	55-1194	302	TA-073	53-1270	291	TA-635	53-1256	291	TB-059	52-1235	285	TB-314	52-1435	288	TS-029	54-1071	294
ST-402	55-1193	302	TA-074	53-1271	291	TA-650	53-1371	292	TB-060	52-1245	285	TB-315	52-1461	286	TS-034	54-1042	294
ST-403	55-1192	302	TA-075	53-1273	291	TA-651	53-1381	292	TB-061	52-1225	285	TB-316	52-1463	286	TS-035	54-1043	294
ST-404	55-1191	302	TA-076	53-1275	291	TA-654	53-1372	292	TB-064	52-1011	283	TB-317	52-1410	288	TS-085	54-1049	294
ST-405	55-1195	302	TA-077	53-1277	291	TA-655	53-1382	292	TB-064-01	52-1016	283	TB-317	52-1467	286	TS-089	54-1021	294
ST-406	55-1196	302	TA-078	53-1279	291	TA-659	53-1374	292	TB-064-02	52-1017	283	TB-318	52-1412	288	TS-093	54-1029	294
ST-417	55-1151	301	TA-079	53-1286	291	TA-670	53-1384	292	TB-064-03	52-1018	283	TB-319	52-1414	288	TS-094	54-1030	294
ST-418	55-1152	301	TA-080	53-1287	291	TA-675	53-1391	292	TB-065	52-1012	283	TB-320	52-1416	288	TS-095	54-1035	294
ST-419	55-1153	301	TA-081	53-1289	291	TA-680	53-1362	292	TB-066	52-1021	283	TB-321	52-1418	288	TS-096	54-1012	294
ST-423	55-1034	299	TA-082	53-1290	291	TA-681	53-1361	292	TB-066-01	52-1026	283	TB-322	52-1420	286	TS-097	54-1031	294
ST-424	55-1033	299	TA-083	53-1291	291	TA-700	53-1111	290	TB-066-02	52-1027	283	TB-323	52-1422	286	TS-098	54-1017	294
ST-500	55-1204	303	TA-084	53-1293	291	TA-702	53-1112	290	TB-066-03	52-1028	283	TB-324	52-1424	286	TS-099	54-1011	294
ST-501	55-1205	303	TA-085	53-1295	291	TA-703	53-1113	290	TB-067	52-1022	283	TB-325	52-1426	286	TS-100	54-1015	294
ST-502	55-1206	303	TA-086	53-1297	291	TA-705	53-1121	290	TB-068	52-1031	283	TB-325-01	52-1428	286	TS-101	54-1025	294
ST-503	55-1207	303	TA-087	53-1299	291	TA-706	53-1122	290	TB-069	52-1032	283	TB-326	52-1512	287	TS-102	54-1046	294
ST-504	55-1201	303	TA-088	53-1300	291	TA-707	53-1123	290	TB-070	52-1041	283	TB-326-01	52-1511	287	TS-103	54-1051	294
ST-505	55-1166	301	TA-089	53-1280	291	TA-709	53-1131	290	TB-071	52-1042	283	TB-327	52-1516	287	TS-104	54-1052	294
ST-510	55-1027	305	TA-090	53-1311	292	TA-710	53-1132	290	TB-075	52-1015	283	TB-327-01	52-1515	287	TS-105	54-1053	294
ST-511	55-1028	305	TA-091	53-1312	292	TA-711	53-1133	290	TB-076	52-1025	283	TB-328	52-1518	287	TS-109	54-1057	294
ST-515	55-1275	303	TA-092	53-1313	292	TA-713	53-1141	290	TB-077	52-1035	283	TB-328-01	52-1517	287	TS-110	54-1058	294
ST-516	55-1276	303	TA-093	53-1314	292	TA-714	53-1142	290	TB-078	52-1045	283	TB-329	52-1319	285	TS-111	54-1047	294
ST-520	55-1211	304	TA-098	53-1282	291	TA-715	53-1143	290	TB-079	52-1501	286	TB-330	52-1320	285	TS-121	54-1111	295
ST-521	55-1212	304	TA-099	53-1281	291	TA-717	53-1151	290	TB-080	52-1502	286	TB-331	52-1311	285	TS-121-01	54-1114	295
ST-525	55-1251	306	TA-101	53-1051	290	TA-718	53-1152	290	TB-140	52-1211	283	TB-332	52-1312	285	TS-127-01	54-1091	295
TA-010	53-1022	290	TA-102	53-1052	290	TA-719	53-1153	290	TB-141	52-1212	283	TB-334	52-1315	285	TS-128	54-1092	295
TA-011	53-1032	290	TA-103	53-1053	290	TB-001	52-1111	282	TB-144	52-1001	283	TB-335	52-1316	285	TS-199	54-1136	124
TA-012	53-1042	290	TA-104	53-1054	290	TB-002	52-1112	282	TB-145	52-1002	283	TB-336	52-1323	285	TS-200	54-1139	125
TA-013	53-1012	290	TA-105	53-1055	290	TB-002-01	52-1115	282	TB-146	52-1004	283	TB-337	52-1324	285	TS-209	54-1121	125
TA-014	53-1023	290	TA-201	53-1061	290	TB-003	52-1105	282	TB-147	52-1005	283	TB-338	52-1331	285	TS-210	54-1122	125
TA-015	53-1033	290	TA-204	53-1064	290	TB-005-01	52-1121	282	TB-150	52-1051	284	TB-339	52-1359	285	TS-211	54-1137	125
TA-016	53-1043	290	TA-205	53-1065	290	TB-005-02	52-1122	282	TB-151	52-1052	284	TB-340	52-1360	285	TS-220	54-1135	124
TA-017	53-1013	290	TA-301	53-1071	290	TB-006	52-1125	282	TB-155	52-1061	284	TB-341	52-1351	285	TS-222	54-1134	124
TA-018	53-1024	290	TA-304	53-1074	290	TB-007	52-1131	282	TB-156	52-1062	284	TB-342	52-1352	285	TS-240	54-1131	124
TA-019	53-1034	290	TA-305	53-1075	290	TB-008	52-1132	282	TB-161	52-1071	284	TB-344	52-1355	285	TS-241	54-1132	124
TA-020	53-1044	290	TA-401	53-1081	290	TB-009	52-1135	282	TB-162	52-1072	284	TB-345	52-1356	285	TS-242	54-1133	124
TA-021	53-1014	290	TA-404	53-1084	290	TB-010	52-1151	282	TB-163	52-1075	284	TB-346	52-1363	285	TS-300	54-1141	125
TA-022	53-1025	290	TA-405	53-1085	290	TB-011	52-1152	282	TB-164	52-1076	284	TB-347	52-1364	285	TS-310	30-1201	125
TA-023	53-1035	290	TA-411	53-1091	290	TB-012	52-1155	282	TB-165	52-1077	284	TB-348	52-1371	285	TS-311	30-1202	125
TA-024	53-1045	290	TA-413	53-1095	290	TB-013	52-1161	283	TB-166	52-1078	284	TB-350	52-1340	285	TS-312	30-1203	125
TA-025	53-1015	290	TA-501	53-1211	291	TB-014	52-1162	283	TB-170	52-1055	284	TB-354	52-1380	285	TS-312-01	30-1206	125
TA-026	53-1026	290	TA-502	53-1212	291	TB-015	52-1165	283	TB-171	52-1056	284	TB-358	52-1532	287	TS-312-02	30-1207	125
TA-027	53-1036	290	TA-503	53-1213	291	TB-016	52-1163	283	TB-172	52-1057	284	TB-359	52-1531	287	TS-312-03	30-1208	125
TA-028	53-1046	290	TA-504	53-1214	291	TB-017	52-1164	283	TB-175	52-1065	284	TB-360	52-1525	287	TS-312-04	30-1209	125
TA-029	53-1016	290	TA-505	53-1215	291	TB-019	52-1101	282	TB-175-01	52-1064	284	TB-360	52-1535	287	TS-312-05	30-1210	125
TA-030	53-1021	290	TA-515	53-1221	291	TB-020	52-1171	283	TB-176	52-1066	284	TB-361	52-1524	287	TS-312-06	30-1211	125
TA-031	53-1031	290	TA-525	53-1222	291	TB-021	52-1176	283	TB-200	52-1192	283	TB-362	52-1522	287	TS-312-07	30-1212	125
TA-032	53-1041	290	TA-535	53-1223	291	TB-022	52-1143	283	TB-201	52-1191	283	TB-363	52-1481	286	TS-312-08	30-1213	125
TA-033	53-1011	290	TA-545	53-1224	291	TB-023	52-1144	283	TB-203	52-1181	283	TB-364	52-1483	286	TS-312-09	30-1214	125
TA-050	53-1321	292	TA-555	53-1225	291	TB-024	52-1102	282	TB-204	52-1182	283	TB-366	52-1473	286	TS-312-10	30-1215	125
TA-051	53-1322	292	TA-560	53-1231	293	TB-025	52-1141	282	TB-205	52-1186	283	TB-399	52-1490	286	TS-316	30-1218	125
TA-052	53-1323	292	TA-561	53-1234	293	TB-026	52-1142	282	TB-206	52-1185	283	TB-400	52-1493	286	TW-101	56-1211	311
TA-053	53-1324	292	TA-562	53-1235	293	TB-027	52-1145	282	TB-207	52-1195	283	TB-401	52-1491	286	TW-103	56-1213	311
TA-054	53-1325	292	TA-563	53-1232	293	TB-037	52-1567	287	TB-208	52-1188	283	TB-401-01	52-1492	286	TW-105	56-1215	311
TA-060	53-1331	292	TA-564	53-1233	293	TB-038	52-1561	287	TB-208-01	52-1189	283	TB-401-02	52-1494	286	TW-107	56-1217	311
TA-062	53-1333	292	TA-565	53-1241	293	TB-039	52-1562	287	TB-300	52-1271	284	TB-402	52-1495	286	TW-110	56-1221	311
TA-063	53-1334	292	TA-566	53-1244	293	TB-040	52-1563	287	TB-303	52-1272	284	TB-403	52-1451	286	TW-111	56-1222	311
TA-064	53-1335	292	TA-567	53-1245	293	TB-041	52-1564	287	TB-307	52-1275	284	TB-404	52-1452	286	TW-113	56-1224	311
TA-065	53-1336	292	TA-568	53-1242	293	TB-042	52-1565	287	TB-308	52-1251	284	TB-405	52-1453	286	TW-114	56-1223	311
TA-066	53-1261	291	TA-569	53-1243	293	TB-049	52-1222	285	TB-308-01	52-1252	284	TB-406	52-1454	286	TW-115	56-1226	311
TA-067	53-1262	291	TA-601	53-1251	291	TB-050	52-1221	285	TB-308-02	52-1255	284	TS-010	54-1061	294	TW-116	56-1225	311
TA-068	53-1263	291	TA-602	53-1253	291	TB-051	52-1231	285	TB-309	52-1261	284	TS-014	54-1062	294	TW-117	56-1228	311
TA-070	53-1266	291	TA-603	53-1255	291	TB-052	52-1232	285	TB-309-01	52-1262	284	TS-018	54-1063	294	TW-118	56-1227	311









OLD # TO NEW



OLD #	NEW #	PG#	OLD #	NEW #	PG#	OLD #	NEW #	PG#	OLD #	NEW #	PG#	OLD #	NEW #	PG#
TW-201	56-1148	268	TW-918	56-1032	118	UL-064	28-1161	104	WA-007-19	58-1193	322	WA-039-11	58-1179	322
TW-400	56-1281	312	TW-919	56-1035	118	UL-064-01	28-1162	104	WA-008	58-1117	319	WA-039-12	58-1180	320
TW-401	56-1261	312	TW-921	56-1022	118	UL-065	28-1143	104	WA-009	58-1118	319	WA-040	49-1227	321
TW-402	56-1262	312	TW-922	56-1023	118	UL-066	28-1151	104	WA-009-01	58-1121	319	WA-041	58-1186	321
TW-403	56-1263	312	TW-923	56-1024	118	UL-066-01	28-1152	104	WA-009-02	58-1122	319	WA-042	58-1181	321
TW-404	56-1266	312	TW-924	56-1021	118	UL-066-02	28-1153	104	WA-009-03	58-1123	319	WA-042	58-1188	321
TW-405	56-1292	312	TW-925	56-1025	118	UL-070	28-1053	103	WA-009-04	58-1124	319	WA-043	58-1182	321
TW-406	56-1291	312	TW-926	56-1044	118	UL-071	28-1054	103	WA-009-05	58-1125	319	WA-044	58-1183	321
TW-420	56-1282	312	TW-926-01	56-1045	118	UL-072	28-1051	103	WA-009-06	58-1126	319	WA-045	58-1151	321
TW-421	56-1271	312	TW-927	56-1043	118	UL-073	28-1052	103	WA-009-10	58-1119	319	WA-046	58-1152	321
TW-422	56-1272	312	TW-928	56-1042	118	UL-074	28-1055	103	WA-011	58-1113	319	WA-071	58-1212	317
TW-423	56-1273	312	TW-929	56-1063	118	UL-075	28-1056	103	WA-011-01	58-1116	319	WA-072	58-1211	317
TW-444	50-1118	271	TW-930	56-1064	118	UL-076	28-1057	103	WA-011-02	58-1114	319	WA-073	58-1216	317
TW-445	50-1119	271	TW-930-01	56-1065	118	UL-080	28-1237	102	WA-014	58-1136	320	WA-073-01	58-1221	322
TW-458	56-1311	105	TW-930-02	56-1066	118	UL-081	28-1238	102	WA-015	58-1141	320	WA-073-02	58-1521	323
TW-460	56-1312	105	TW-931	56-1083	118	UL-085	28-1225	105	WA-017	58-1098	318	WA-073-03	58-1523	323
TW-462	56-1313	105	TW-932	56-1084	118	UL-085-01	28-1226	105	WA-018	58-1089	318			
TW-470	56-1231	312	TW-935	56-1111	119	UL-085-02	28-1227	105	WA-019	58-1131	320			
TW-471	56-1234	312	TW-936	56-1112	119	UL-086	28-1211	105	WA-020	58-1144	320			
TW-472	56-1295	268	TW-937	56-1113	119	UL-086-01	28-1212	105	WA-021	58-1132	320			
TW-473	56-1242	268	TW-938	56-1114	119	UL-086-02	28-1213	105	WA-022	58-1108	319			
TW-474	56-1241	268	TW-939	56-1115	309	UL-087	28-1221	105	WA-022-01	58-1103	319			
TW-475	56-1251	312	TW-950	56-1158	268	UL-088	28-1224	105	WA-022-02	58-1104	319			
TW-476	56-1252	312	TW-960	56-1183	309	UL-108	28-1011	102	WA-022-03	58-1102	319			
TW-477	56-1253	312	TW-970	56-1151	268	UL-109	28-1012	102	WA-022-04	58-1101	319			
TW-478	56-1254	312	UL-003	28-1131	104	UL-110	28-1013	102	WA-023	58-1133	320			
TW-801	56-1161	310	UL-003-01	28-1132	104	UL-111	28-1014	102	WA-025	58-1066	317			
TW-803	56-1163	310	UL-004	28-1133	104	UL-112	28-1015	102	WA-025-01	58-1065	317			
TW-805	56-1165	310	UL-004-01	28-1134	104	UL-113	28-1016	102	WA-025-04	58-1064	317			
TW-807	56-1167	310	UL-005	28-1123	104	UL-114	28-1017	102	WA-027	58-1077	317			
TW-809	56-1153	310	UL-006	28-1122	104	UL-115	28-1018	102	WA-027-01	58-1078	317			
TW-810	56-1171	311	UL-007	28-1121	104	UL-116	28-1019	102	WA-027-02	58-1079	317			
TW-811	56-1172	311	UL-008	28-1032	107	UL-117	28-1020	102	WA-028	58-1071	317			
TW-814	56-1173	311	UL-009	28-1031	107	UL-118	28-1021	102	WA-028-01	58-1072	317			
TW-815	56-1174	311	UL-017	52-1741	288	UL-119	28-1022	102	WA-028-02	58-1073	317			
TW-820	56-1146	268	UL-018	52-1742	288	UL-120	28-1023	102	WA-028-04	58-1081	318			
TW-821	56-1147	268	UL-020	52-1731	288	UL-121	28-1024	102	WA-028-05	58-1082	318			
TW-838	56-1122	119	UL-022	52-1732	288	UL-125	28-1026	102	WA-028-08	58-1094	318			
TW-839	56-1123	119	UL-023	28-1111	103	UL-125-01	28-1027	102	WA-029	58-1016	316			
TW-840	56-1124	119	UL-024	28-1112	103	UL-125-02	28-1028	102	WA-029-01	58-1017	316			
TW-870	56-1141	309	UL-025	28-1113	103	UL-131	52-1761	288	WA-029-02	58-1024	316			
TW-871	56-1142	309	UL-026	28-1114	103	UL-131-01	52-1763	288	WA-029-03	48-1076	316			
TW-872	56-1143	309	UL-028	28-1171	104	UL-131-02	52-1764	288	WA-029-04	58-1011	316			
TW-873	56-1144	309	UL-029	28-1172	104	WA-001	58-1085	318	WA-029-05	58-1012	316			
TW-874	56-1145	309	UL-037	28-1061	103	WA-002	58-1084	318	WA-029-06	58-1013	316			
TW-890	56-1131	119	UL-038	28-1062	103	WA-002-01	58-1091	318	WA-029-07	58-1014	316			
TW-891	56-1132	119	UL-039	28-1063	103	WA-003	58-1106	319	WA-029-08	58-1004	316			
TW-892	56-1133	119	UL-040	52-1735	288	WA-004	58-1112	319	WA-029-09	58-1005	316			
TW-893	56-1134	119	UL-043	52-1736	288	WA-005	58-1086	318	WA-029-10	58-1021	316			
TW-900	56-1181	309	UL-044	52-1711	288	WA-006	58-1087	318	WA-029-11	58-1018	319			
TW-901	56-1012	118	UL-045	52-1721	288	WA-006-01	58-1088	318	WA-029-15	58-1009	316			
TW-902	56-1013	118	UL-045-01	52-1722	288	WA-007	58-1043	317	WA-037	58-1090	318			
TW-903	56-1014	118	UL-046-01	42-1431	230	WA-007-01	58-1042	317	WA-038	58-1161	322			
TW-904	56-1011	118	UL-047-01	42-1432	230	WA-007-02	58-1041	317	WA-039	58-1162	322			
TW-905	56-1054	118	UL-048	52-1544	287	WA-007-05	58-1044	317	WA-039-01	58-1164	322			
TW-906	56-1053	118	UL-049	52-1543	287	WA-007-06	58-1045	317	WA-039-02	58-1165	322			
TW-907	56-1015	118	UL-050	52-1542	287	WA-007-08	58-1051	317	WA-039-03	58-1166	322			
TW-908	56-1055	118	UL-051	52-1541	287	WA-007-09	58-1052	317	WA-039-04	58-1167	322			
TW-909	56-1056	118	UL-053	52-1548	287	WA-007-10	58-1053	317	WA-039-05	58-1168	322			
TW-910	56-1073	118	UL-054	52-1547	287	WA-007-12	58-1057	317	WA-039-06	58-1169	322			
TW-911	56-1074	118	UL-055	52-1546	287	WA-007-13	58-1058	317	WA-039-07	58-1170	322			
TW-912	56-1075	118	UL-059	28-1141	104	WA-007-14	58-1059	317	WA-039-08	58-1175	322			
TW-916	56-1034	118	UL-060	52-1553	287	WA-007-17	58-1191	322	WA-039-09	58-1177	322			
TW-917	56-1033	118	UL-061	28-1142	104	WA-007-18	58-1192	322	WA-039-10	58-1178	322			



OLD # TO NEW#

Type of Operations					 		
	Use the proper gloves for the work application.	Select the correct safety goggles for the type of work.	Check input voltage and wiring before start up.	Do not exceed safe operating speeds.	Protect yourself against toxic fumes and flames.	Avoid breathing airborne dust particles.	For Proper use of equipment read instruction manual.
BENCH WORK	●	●					
DAPPING	●	●					
FLEXSHAFT	●	●	●	●			●
ENGRAVING	●	●	●				●
DRILLING	●	●	●	●			●
GRINDING	●	●	●	●			●
BUFFING	●	●	●	●			●
CARVING	●	●	●	●	●	●	●
FINISHING	●	●	●	●		●	●
MELTING	●	●	●		●	●	●
CLEANING	●	●	●	●		●	●
SURFACE FINISHING	●	●	●	●	●	●	●
POLISHING	●	●	●	●	●	●	●
PLATING	●	●	●		●	●	●
SOLDERING	●	●	●		●	●	●
BRAZING	●	●			●	●	●



THIS ICON IS INTENDED TO DRAW YOUR ATTENTION TO SPECIFIC SAFETY PRACTICES WHEN WORKING WITH TOOLS AND EQUIPMENT LISTED IN THE CATALOG.



A great set of chasing toolsis hard to find!

Finally, a unique set of chasing tools developed by a professional chaser!

Silversmithing Educator and Master Chaser, Liza Nechamkin-Glasser developed these tools for professionals and students alike.

These tools are precisely shaped, comfortable to hold and travel smoothly across your metal-work. While it is true, chasing styles vary and a chaser can never have too many chasing tools, this twenty-two piece set is a great start, or addition, to any chasing tool collection.

This collection comes as a set in its own durable container.

Individual chasing tools are also available.



KerrLab. Application Specific Investments.

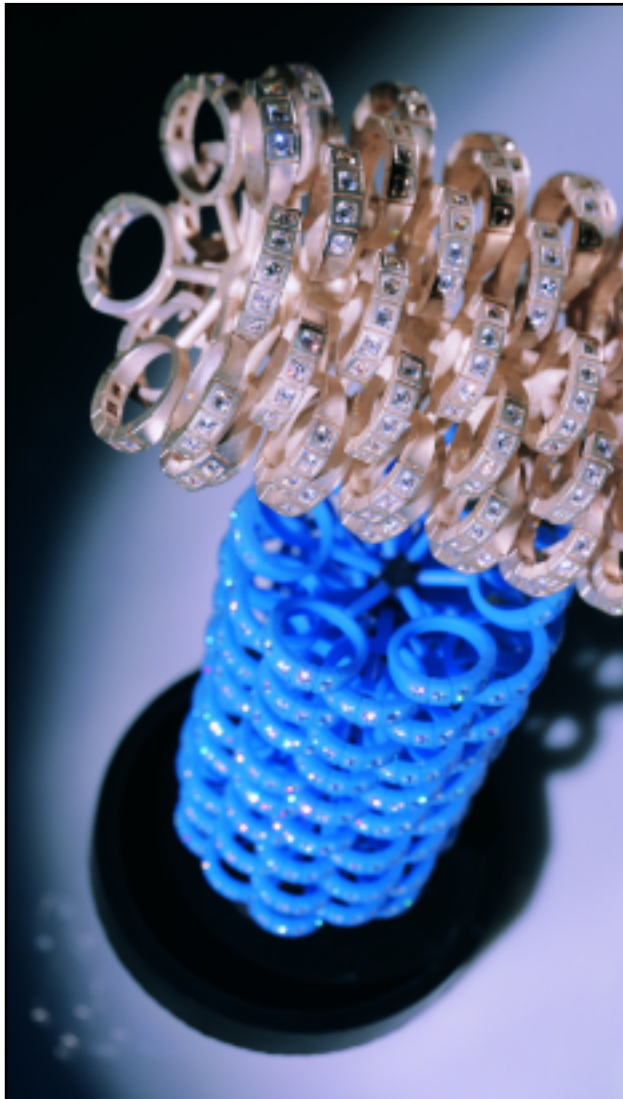

KerrCast 2000
Gold & Silver



Satin Cast Original
Quality Gold & Silver



Supervest 20
Large Jewelry / Sculpture



Satin Cast 20
Highest Quality
Gold & Silver



Satin Cast Xtreme
Highest Quality
White Golds



Satin Cast Diamante
Stone In Place Casting



Platinite
Platinum
& Stainless Steel



Opticast
Highest Quality
Platinum



G400
Aluminum



Innovative New Investment Drum.

- **Tamper proof seal.** Guarantees you are the first to open and use.
- **Fresh.** Easy re-closeable lid to keep contents fresh.
- **Convenient.** Instructions printed right on the back of Drum.
- **Moisture resistant.** All plastic construction means protection from elements.
- **Easy handling.** Built in hand holds make for easy carrying.
- **Easy transport.** Designed to stack snugly on a pallet for safe shipping.
- **Easy storage.** Empty drums nest for optimal storage after use.
- **Recyclable.** 100% recyclable like any household plastic container.
- **Complete line.** Current packaging for all KerrLab Jewelry Investments.

Dazor LED Bench Lights



- **Advanced Illumination Technology**
Delivers 5x the lumen density of a standard 5mm LED
- **Color-Corrected Light**
Provides high quality, consistent 6000°K color with no degradation throughout 50,000 hrs of operating life
- **Effective Thermal Management**
Eliminates noisy fans for quiet operation with no heat forward
- **High Power White LED Light Source**
Directs up to 95% of illumination to the work surface
- **Dimmable**
Down to 30% of full light output with no deterioration of color
- **Light Output**
60% higher than 2-tube fluorescent fixture and 50% higher than 3-tube fixtures
- **Optics**
Built into the LEDs means no need to add or remove diffusers



Qty 6: 1-Watt High Power
LED Universal Power Supply : 100-240V~ 50-60hz
Power Supply Output: 12VDC

Dazor Fluorescent Lamps



Used by professionals in the fields such as

- Inspection and quality control
- Assembly and Repair
- Jewelry manufacturing
- Jewelry repair
- Retail Jewelry
- Drafting
- Dental laboratories
- Office work Stations
- Art and Graphics Design
- Medical/ Forensic Laboratories
- Comes complete with (15W each) bulb, cord and power plug
- Available colors gray or black in either desk or clamp fitting

Available
Color: Black or Gray
Tube: 2 or 3
Fitting: Clamp
or Mount

- Unit is backed by a warranty
- Bulbs are not covered by warranty
- UL approved

Dazor Manufacturing Corp
11727 Dunlap Industrial Drive
Maryland Heights, Missouri 63043
Ph: 314-652-2400 Fx: 314-652-2069
www.dazor.com

Dazor Circline Magnifying Lamps



- Dazor's #1 seller, designed for inspection, assembly and precision work.
- This popular magnifier is a 3-diopter (+75%) made in Crown optical glass.
- The patented floating arm is a well balanced mechanism totally enclosed for elegance and safety.
- UL approved.
- Available colors black, White, Almond, Dove Gray in either desk or clamp fitting

www.dazor.com
for more
products

DAZOR® 

The World Standard in Task Lighting Since 1938

SMITH EQUIPMENT

The Flame
That Keeps
The Other
Flames
Burning.

SMITH EQUIPMENT

The Little Torch™

Accept no substitutes! For more than 40 years The Little Torch has been the #1 torch in the world. Lightweight and superbly balanced for infinite control and flexibility, The Little Torch is the genuine article. It easily handles anything from brazing safety chain to casting up to 3 ounces of gold or silver. It will be the most versatile, trusted tool on your bench. For quality, versatility and precision, choose The Little Torch.

Customer service: 800-843-7912
www.smithequipment.com • www.littletorch.com

Made in the USA



1005



FERRIS® RING TUBES. THIS IS WHERE LEGENDS BEGIN.

Ferris ring tubes. This is the palette from which countless jewelry masterpieces have been created. Unmatched quality. Unrivaled consistency. Unequaled performance. Ferris®. The most trusted brand in jewelry waxes worldwide.

Sold exclusively through authorized Ferris dealers & distributors.

ISO 9001:2000 Certified

ferris*

Ferris Division, The Kindt-Collins Company LLC • www.kindt-collins.com



A DIAMOND SCALE IN THE PALM OF YOUR HAND

VIBE-130

Diameter & weight in a split second
Exact caratage for any shape

SECOND GENERATION
AVAILABLE NOW

▶ DIAMOND / GEM
COUNT MACHINE
0.8 mm up to 9 mm

For Details See Page # 123

DATA
DIAMOND TECHNOLOGY



PRODUCT DESCRIPTION

All products listed in this catalog are specifically for use by Trade Professionals. The broad range of illustrations, specifications, and other related information are current as of the date of this printing. We will continue to offer the latest in technological improvement and there may be occasion that the part shipped will be a later revision of the cataloged product.

PLACING AN ORDER

Orders are welcome by Email, Fax, or Phone. Our qualified staff will make every effort to fill your order rapidly. Please be reminded that Orders for Special products and Non-stock items sometimes take additional time to process and ship. Because the number of new products that we offer continues to escalate, you will notice a new numbering system when identifying parts. Our courteous Sales staff is anxious to assist you wherever possible to locate the products of your choice.

SPECIAL ORDERS

To serve you better, we are receptive to providing products for special needs. Please be aware that special orders typically can not be cancelled and generally are not returnable. Thank you for your understanding.

PRICING POLICY

We have included prices for most of the products in our catalog. The prices mentioned therein may be used as a guide only. The company reserves the right to make changes in the price at any time. Prices may have changed since the publication of this catalog. All prices are NET F.O.B. All orders are subject to prices prevailing at the time of shipment. Suggested retail prices are in US\$. The prices do not include exchange fluctuations, freight/shipping charges, insurance, duties, taxes or other tariffs.

STANDARD PACKAGING QUANTITY

When products are sold in sets or standard quantities, orders received outside of the standard multiples will be adjusted to the next larger multiple.

SHIPMENT METHODS

Standard shipping will be by UPS unless otherwise noted on your order. The necessary information is the name of the contact individual, company, and the full shipping address including zip code. We remain available to ship using alternate carriers if noted on the order. We will continue to make every reasonable effort to package and ship products well, however we shall not be responsible for loss, damage, or delay due to causes beyond our control.

TRUCK SHIPMENT

Orders should spell out in detail the name of the individual, the company, full address including ZIP code. Orders without specific instructions will be shipped by UPS Ikohe will make every effort to ship the ordered merchandise promptly but shall not be held responsible for any loss or damage resulting from delay due to causes beyond our control.

HAZARDOUS MATERIAL SHIPPING

The Department of Transportation (DOT) governs the labeling, packaging, handling, and tracking of a variety of materials that are considered hazardous. In some cases, materials may not be permitted to ship in the same container. Our standard practice is to separate the HAZMAT materials from other products on your order to save you cost in shipping and to avoid problems with conformance to DOT standards. Understandably, these regulations result in extra costs during transit and are the responsibility of the customer.

DROP SHIPMENT

To accomplish this for you, please provide the drop ship company name, address including zip code, and contact individual's name if needed. Additional shipping, handling, and services will apply.

CLAIMS

When merchandise is transferred to the carrier, title automatically transfers to the buyer. For claims regarding shortages or damage, you must file with the carrier promptly to prevent loss. Should a shipment be delayed or lost in transit, please contact us and we will make every effort to track the shipment with the carrier.

RETURN MERCHANDISE

Before merchandise is returned, authorization must be obtained from our Sales Department. Merchandise to be returned is to be accompanied with the Return Authorization Number (RMA) included and also a copy of the applicable invoice. Returns are to be received undamaged, in original packaging, include all accessories, manuals, etc. Stock adjustment returns will not be accepted after three months from the invoice date. Products returned for warranty and repair are to be according to the agreements established during the RMA process.

UMICORE RHODUNA®

271, 272, 275 & SL-C
PLATING ELECTROLYTES
FOR PEN PLATING



UMICORE GOLD PLATING
SOLUTION
AURUNA® 250, 261,
262, 263 & 264
PLATING ELECTROLYTES
FOR PEN PLATING

RHODUNA®

is the Synonym of Rhodium
Electrolytes for Highest Demands

Material for a better life

umicore



Jewelry &
Electroplating



Same Product- New Name

“Degussa Rhodium”
will be

UMICORE RHODUNA®

“DEGUSSA RHODIUM” IS NOW
UMICORE RHODUNA®
RHODUNA J1, J2, TD & SL-C

**ELECTROLYTES FOR PLATING
BATHS**



Special Features

- ◆ Long Lifetime
- ◆ High covering Power
- ◆ Abrasion-resistant
- ◆ Supplied ready for use
- ◆ Easy to operate



Fields of Application

- ◆ Jewelry ◆ Spectacles
- ◆ Trend Setting Designs
- ◆ Writing Instruments
- ◆ Tableware and more.....

Premium Quality Tools.....

**It's what your creations
demand and deserve.**



KHALIFA JEWELLERY

مجوهرات خليفة

Main Office – Machinery & Tools Division

Al Dallal Bldg.- Gold Souk – Al Ras Area
Telephone: 00971 – (0)4-2262619
Office Fax: 00971 – (0)4-2266392
P. O. Box: 55855 , Deira
Dubai – United Arab Emirates.

E-mail:

khalifaj@eim.ae

بريد الكتروني:

المكتب الرئيسي – قسم الماكينات والعدة

مبنى الدلال – سوق الذهب – منطقة الراس
هاتف المحل : ٢٢٦٢٦١٩ – (٠)٤ – ٠٠٩٧١
فاكس المكتب : ٢٢٦٦٣٩٢ – (٠)٤ – ٠٠٩٧١
صندوق بريد : ٥٥٨٥٥ ، دييرة
دبي – الإمارات العربية المتحدة

Machinery & Tools Divisions

Showroom Nø. G – 63 B	Showroom Nø. 1 D01 - Bldg. 1
Gold and Diamond Park	Dubai Multi Commodities Center
Sheikh Zayed Road – Dubai	Sheikh Zayed Road – Dubai
Tel : 04 – 3474822	Tel : 04 – 3688618

أقسام الماكينات والعدة

المعرض رقم ١ د ١ – مبنى ١	المعرض رقم ج – ٦٣ ب
مركز دبي للسلع المتعددة	مجمع الذهب والألماس
شارع الشيخ زايد – دبي	شارع الشيخ زايد – دبي
هاتف : ٣٦٨٨٦١٨ – ٠٤	هاتف : ٣٤٧٤٨٢٢ – ٠٤

Silver Wholesale & Tools Divisions

Golden Star Hotel	Central Market – Block 8
Gold Souk – Deira – Dubai	Telephone: 06- 5724772
Tel : 04 – 2266065	P. O. Box : 3735 – Sharjah
Fax : 04 – 2266863	United Arab Emirates.

قسم الفضة بالجملة وقسم العدة

السوق المركزي – بلوك ٨	فندق النجمة الذهبية
هاتف : ٥٧٢٤٧٧٢ – ٠٦	سوق الذهب – دييرة – دبي
ص ب : ٣٧٣٥ – الشارقة	هاتف : ٢٢٦٦٠٦٥ – ٠٤
الإمارات العربية المتحدة.	فاكس : ٢٢٦٦٨٦٣ – ٠٤

BIJOUTERIE FARAH – LEBANON

مجوهرات فرح – لبنان

Main Office – Machinery & Tools Division

Master Mall – Harboyan Trade Center
Mobile : 00961 – (0)3 – 361525 / 303960
Telephone: 00961 – (0)1 – 240777
Office Fax: 00961 – (0)1 – 240888
P. O. Box: 801070 Bourj hammoud – Lebanon.

E-mail:

bijouteriefarah@gmail.com

بريد الكتروني:

المكتب الرئيسي – قسم الماكينات والعدة

ماستر مول – هاربويان توريد سنتر
خليوي : ٣٠٣٩٦٠ / ٣٦١٥٢٥ – (٠)٣ – ٠٠٩٦١
هاتف المعرض : ٢٤٠٧٧٧ – (٠)١ – ٠٠٩٦١
فاكس المكتب : ٢٤٠٨٨٨ – (٠)١ – ٠٠٩٦١
صندوق بريد : ٨٠١٠٧٠ – برج حمود – لبنان

Web-site:

www.khalifaj.com

الموقع الإلكتروني :

حافظوا على أموالكم في المحلات التي تحفظ قيمتها لكم

SAVE YOUR MONEY AT THE SHOPS THAT SAVE IT FOR YOU